

Instant Pot

INSTANT POT® **PRO**
MULTI-COOKER

Instant™

TABLE OF CONTENTS

IMPORTANT SAFEGUARDS	3
Special cord set instructions	8
Product specifications	8
Product, parts and accessories	9
Get started	11
Initial set up	11
Initial test run (water test)	12
Pressure Cooking 101	14
Control panel	18
Status messages	20
Settings	21
Pressure control features	23
Cooking	28
Smart Programme overview	29
Pressure Cook and Rice	31
Steam	33
Sauté	35
Deglazing	36
Slow Cook	37
Sous Vide	38
Yogurt	43
Bake	46
Keep Warm	47
Using Favourite Programmes	48
Care, cleaning and storage	49
Troubleshooting	53
Warranty	56
Contact	58



IMPORTANT SAFEGUARDS



⚠ WARNING

At Instant Brands™ your safety always comes first. The Instant Pot® Pro was designed with your safety in mind.

As always, be cautious when using electrical appliances and follow basic safety precautions.

1. READ ALL INSTRUCTIONS, SAFEGUARDS AND WARNINGS BEFORE USE. FAILURE TO FOLLOW THESE SAFEGUARDS AND INSTRUCTIONS MAY RESULT IN INJURY AND/OR PROPERTY DAMAGE.
2. Use only the Instant Pot Pro lid with the Instant Pot Pro multicooker base. Using any other multicooker lids may cause injury and/or damage.
3. For household use only. Not for commercial use. Do not use the appliance for anything other than its intended use.
4. For countertop use only. Always operate the appliance on a stable, non-combustible, level surface.
 - Do not place on anything that may block the vents on the bottom of the appliance.
 - Do not place on a hot stove.
5. Heat from an external source will damage the appliance.
 - DO NOT place the appliance on or close to a hot gas or electric burner, or a heated oven.
 - DO NOT use the appliance near water or flame.
 - DO NOT use outdoors. Keep out of direct sunlight.
6. DO NOT touch the appliance's hot surfaces. Only use the side handles for carrying or moving.
 - DO NOT move the appliance when it is under pressure.
 - DO NOT touch accessories during or immediately after cooking.
 - DO NOT touch the metal portion of the lid when the appliance is in operation; this could result in injury.
 - Always use proper hand protection when removing hot accessories, and to handle the hot inner pot.
 - Always place hot accessories on a heat-resistant surface or cooking plate.

⚠ WARNING

Read this manual carefully and completely and retain for future reference. Failure to adhere to safety instructions may result in serious injury or damage.



IMPORTANT SAFEGUARDS



⚠ WARNING

7. The removable inner pot can be extremely heavy when full of ingredients. Care should be taken when lifting the inner pot from the multicooker base to avoid burn injury.
 - Extreme caution must be used when the inner pot contains hot food, hot oil or other hot liquids.
 - Do not move the appliance while it is in use and use extreme caution when disposing of hot grease.
8. **⚠ CAUTION** Overfilling may cause a risk of clogging the steam release pipe and developing excess pressure.
 - DO NOT fill over the **Max PC Fill** line as indicated on the inner pot.
 - DO NOT fill the inner pot over the **Half Fill** line (as indicated on the inner pot) when cooking foods that expand during cooking such as rice or dried vegetables.
9. **⚠ WARNING** This appliance cooks under pressure. Any pressure in the appliance can be hazardous. Allow the appliance to depressurise naturally or release all excess pressure before opening. Inappropriate use may result in burns, injury and/or property damage.
 - Make sure the appliance is properly closed before operating. **Refer to Pressure control features: multicooker lid.**
 - DO NOT cover or obstruct the steam release valve and/or float valve with cloth or other objects.
 - DO NOT attempt to open the appliance until it has depressurised, and all internal pressure has been released. Attempting to open the appliance while it is still pressurised may lead to sudden release of hot contents and may cause burns or other injuries.
 - DO NOT place your face, hands or exposed skin over the steam release valve or float valve when the appliance is in operation or has residual pressure.
 - DO NOT lean over the appliance when removing the lid, as heat and steam escape when the lid is removed.
 - Turn the appliance off if steam escapes from the steam release valve and/or float valve in a steady stream during Pre-heating or Cooking,

⚠ WARNING

Read this manual carefully and completely and retain for future reference. Failure to adhere to safety instructions may result in serious injury or damage.



IMPORTANT SAFEGUARDS



⚠ WARNING

for longer than 3 minutes.

- If steam escapes from the sides of the lid, turn the appliance off and make sure the sealing ring is properly installed. Refer to **Pressure control features: sealing ring**.
 - DO NOT attempt to force the lid off the Instant Pot multicooker base. Refer to **Releasing pressure**.
10. When cooking meat with skin (e.g. sausage with casing), the skin can swell when heated. Do not pierce the skin while it is swollen; this could result in scalding injury.
 11. When pressure cooking food with a doughy or thick texture, or a high fat/oil content, contents may splatter when opening the lid. Follow recipe instructions for pressure release method. Refer to **Releasing pressure**.
 12. Oversized foods and/or metal utensils must not be inserted into the inner pot as they may cause risk of fire and/or personal injury.
 13. Proper maintenance is recommended before and after each use:
 - Check the steam release valve, steam release pipe, anti-block shield and float valve for clogging;
 - Before inserting the inner pot into the multicooker base, make sure both parts are dry and free of food debris;
 - Let the appliance cool to room temperature before cleaning or storage.
 14. Do not use this appliance for deep frying or pressure frying with oil.
 15. To disconnect, touch **Cancel**, then remove plug from power source. Always unplug when not in use, as well as before adding or removing parts or accessories, and before cleaning. To unplug, grasp the plug and pull from the outlet. Never pull from the power cord.
 16. Regularly inspect the appliance and power cord. Do not operate the appliance if the power cord or plug is damaged, or after the appliance malfunctions or is dropped or damaged in any manner. For assistance, contact Customer Care by email at support@instantpot.com.au or by phone at **1800 251 643 or (02) 9317 1000**.
 17. Spilled food can cause serious burns. A short power-supply cord is provided to reduce the hazards resulting from grabbing, entanglement and tripping.

⚠ WARNING

Read this manual carefully and completely and retain for future reference. Failure to adhere to safety instructions may result in serious injury or damage.



IMPORTANT SAFEGUARDS



⚠️ WARNING

- DO NOT let the power cord hang over edges of tables or counters, or touch hot surfaces or open flame, including the stovetop.
 - DO NOT use below-counter power outlets, and never use with an extension cord.
 - Keep the appliance and cord away from children.
18. Do not use any accessories or attachments not authorised by Instant Brands LLC. The use of parts, accessories or attachments not recommended by the manufacturer may cause a risk of injury, fire or electric shock.
 - To reduce the risk of pressure leakage, cook only in an authorised stainless steel Instant Pot inner pot made for this model.
 - DO NOT use the appliance without the removable inner pot installed.
 - To prevent personal injury and damage to the appliance, only replace the sealing ring with an authorised Instant Pot sealing ring.
 19. DO NOT attempt to repair, replace or modify components of the appliance, as this may cause electric shock, fire or injury, and will void the warranty.
 20. Do not tamper with any of the safety mechanisms, as this may result in injury or property damage.
 21. The multicooker base contains electrical components. To avoid electrical shock:
 - DO NOT put liquid of any kind into multicooker base;
 - DO NOT immerse power cord, plug or the appliance in water or other liquid;
 - DO NOT rinse the appliance under tap.
 22. Do not use the appliance in electrical systems other than 220-240V~ 50-60Hz. Do not use with power converters or adapters.
 23. This appliance is NOT to be used by children or by persons with reduced physical, sensory or mental capabilities. Close supervision is necessary when any appliance is used near children and these individuals. Children should not play with this appliance.
 24. Do not leave the appliance unattended while in use. Never connect this appliance to an external timer switch or separate remote-control system.

⚠️ WARNING

Read this manual carefully and completely and retain for future reference. Failure to adhere to safety instructions may result in serious injury or damage.



IMPORTANT SAFEGUARDS



⚠️ WARNING

25. Do not store any materials in the multicooker base or inner pot when not in use.
26. Do not place any combustible materials in the multicooker base or inner pot, such as paper, cardboard, plastic, Styrofoam or wood.
27. Do not use the included accessories in a microwave, toaster oven, or outdoor grill.

SAVE THESE INSTRUCTIONS

⚠️ WARNING

To avoid injury, read and understand instruction manual before using this machine.

⚠️ WARNING

Electrical shock hazard. Use grounded outlet only.

- DO NOT remove ground.
- DO NOT use an adapter.
- DO NOT use an extension cord.

Failure to follow instructions can cause electrical shock and/or serious injury.

⚠️ WARNING

THE FAILURE TO FOLLOW ANY OF THE IMPORTANT SAFEGUARDS AND THE IMPORTANT INSTRUCTIONS FOR SAFE USE IS A MISUSE OF YOUR APPLIANCE THAT CAN VOID YOUR WARRANTY AND CREATE THE RISK OF SERIOUS INJURY.

⚠️ WARNING

Read this manual carefully and completely and retain for future reference. Failure to adhere to safety instructions may result in serious injury or damage.



IMPORTANT SAFEGUARDS



SPECIAL CORD SET INSTRUCTIONS

Per safety requirement, a short power supply cord is provided to reduce the hazards resulting from entanglement and tripping.

This appliance has a 3-prong grounding plug. To reduce the risk of electric shock, plug the power cord into a grounded electrical outlet that is easily accessible.

PRODUCT SPECIFICATIONS

Model: Pro 60	1000-1200W	220-240V~ 50-60Hz	5.7 Litres	5.9 kg	cm: 33.1 x 32.2 x 32.5
Model: Pro 80	1200-1400W	220-240V~ 50-60Hz	8 Litres	7.18 kg	cm: 36.5 x 35.3 x 36.0

Find your model name and serial number

Find the **model name** on the silver rating label on the back of the multicooker base, near the power cord. The **serial number** is located on a white sticker beside the rating label.

WARNING

Read this manual carefully and completely and retain for future reference. Failure to adhere to safety instructions may result in serious injury or damage.

PRODUCT, PARTS AND ACCESSORIES

Before using your new Instant Pot Pro, make sure everything is accounted for, then see **Care, cleaning and storage: Removing and installing parts** to find out how everything fits together.

Top of multicooker lid

Steam release assembly

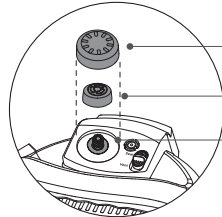

Steam release cover

Steam release valve

Steam release pipe

Lid fin

Lid handle

QuickCool™ protective cover

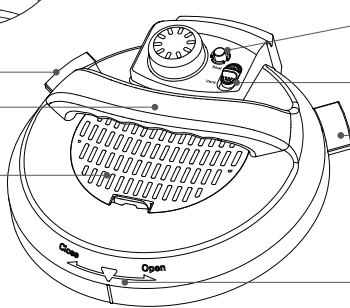

Float valve

Quick release switch

Lid fin

Lid position markers

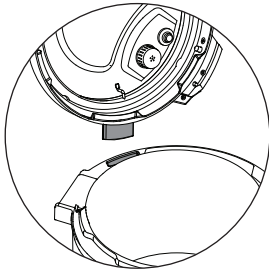

Instant Tip: Stand the multicooker lid up to keep it off your countertop. Insert the left or right lid fin into corresponding lid holders on the base to stand it up and save some space!

Bottom of multicooker lid

Sealing ring

Sealing ring rack

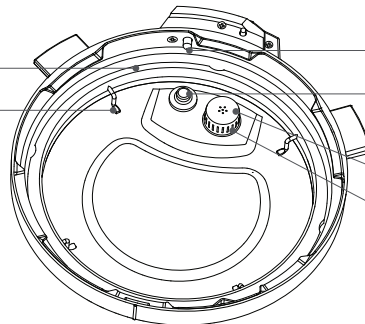

Locking pin

Silicone cap
(bottom of float valve)

Anti-block shield

Steam release pipe
(beneath the anti-block shield)

Illustrations in this document are for reference only and may differ from the actual product. Always refer to the actual product.

PRODUCT, PARTS AND ACCESSORIES

Inner pot

Easy Grip silicone handles

Fill line indicators

Flat bottom

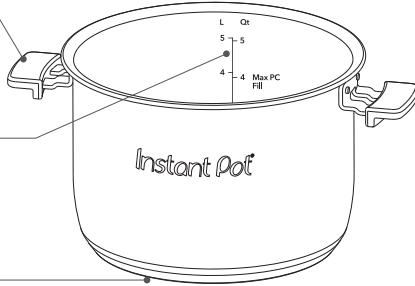

Instant Tip: Stove top and oven-friendly up to 232°C! The inner pot features a cookware-grade impact bonded tri-ply bottom, which sounds complicated, but really just means you can use it just about anywhere – from the multicooker base to any electric, ceramic, gas or induction cooktop.

Multicooker base

Outer pot

Multicooker base handle

Condensation rim

Stainless-steel exterior

Control panel

Heating element
(interior)

Lid holder

Condensation collector
(rear)

Cord holder
(rear)

Power cord
(rear)

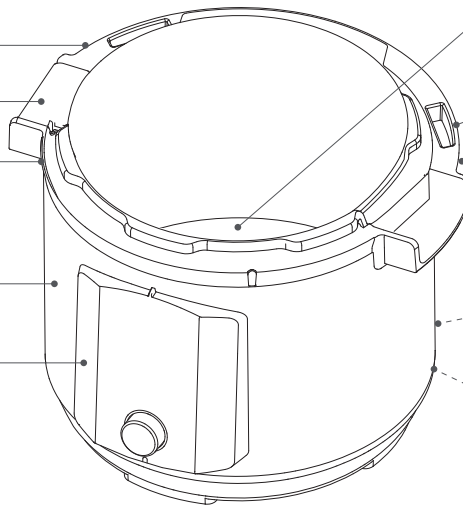

ACCESSORIES

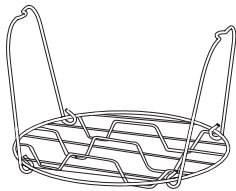

Steam rack

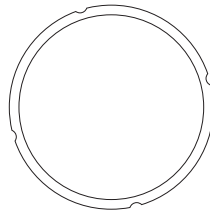



Extra sealing ring

Illustrations in this document are for reference only and may differ from the actual product. Always refer to the actual product.

GET STARTED

INITIAL SET UP

- 01** Pull that Instant Pot Pro out of the box!
- 02** Remove the packaging material and accessories from in and around the multicooker and make sure all the parts are accounted for. See **Product, parts and accessories** for a full parts breakdown.
-  **03** Make sure to check under the inner pot!
- 03** Wash the inner pot in a dishwasher or with hot water and dish soap. Rinse it well with warm, clear water and use a soft cloth to thoroughly dry the outside of the inner pot.
- 04** Wipe the heating element with a soft, dry cloth to make sure there are no stray packaging particles left in the multicooker base.
-  **04** Don't remove the safety warning stickers from the lid (unless specified on the sticker!) or the labels from the back of the multicooker base.
- 05** You may be tempted to put the Pro on your stovetop – *but don't do it!* Place the multicooker base on a stable, level surface, *away* from combustible material and external heat sources.

Is something missing or damaged?

Get in touch with Customer Care by email at support@instantpot.com.au or by phone at **1800 251 643 or (02) 9317 1000**.

Feeling keen?

- While you're doing the **Initial test run (water test)**, read over **Pressure cooking 101** to find out how the magic happens, and read through **Pressure control features** for an in-depth look.

WARNING

Read the **Important safeguards** before using the appliance. Failure to read and follow those instructions for safe use may result in damage to the appliance, property damage or personal injury.

Do not place the appliance on a stovetop or upon another appliance. Heat from an external source will damage the appliance.

Do not place anything on top of the appliance, and do not cover or block the steam release valve or anti-block shield, located on the appliance lid to avoid risk of injury and/or property damage.

GET STARTED

INITIAL TEST RUN (WATER TEST)

Do you *have* to do the water test? No – but getting to know the ins and outs of your new Pro prepares you for success in the kitchen! Take a few minutes to get to know how this tireless kitchen hero works.

Stage 1: Setting up the Pro for pressure cooking

- 01** Remove the inner pot from the multicooker base and fill it to the first line (1) with water.
- 02** Insert the inner pot into the multicooker base.
- 03** Connect the power cord to a 220-240V power source.

The display shows **OFF**.

- 04** Place and close the lid as described in **Pressure control features: Multicooker lid**.

 The lid automatically seals for pressure cooking.

Stage 2: "Cooking" (...but not really, this is just a test!)

- 01** Touch **Pressure Cook**.
- 02** When **Custom** flashes, press the dial to select it and go to the next field.
- 03** When the pressure level flashes, press the dial to select **High** pressure and go to the next field.
- 04** When the time flashes, turn the dial to adjust the cook time to 5 minutes (**00:05**).

Press the dial to confirm the change and go to the next field.

 Customisations are saved to the Smart Programme when cooking begins.

- 05** When **Reminder** flashes, turn the dial to toggle between vent reminder

options. Select **Off** and press the dial to confirm. See **Control panel** for more information.

- 06** Select **Off** and press the dial to confirm.

- 07** Touch **Start** to begin.

 The display shows **On** and the cooking progress bar shows **Pre-heating**.

Keep Warm turns on automatically after some Smart Programmes finish. Touch **Keep Warm** to turn the setting off for this test.

 Instant tip: While the multicooker does its thing, read **Pressure cooking 101** to find out how the magic happens.

Stage 3: Releasing pressure

- 01** When **Cooking** finishes, the display shows **End**.
- 02** If you have set a 5 or 10 minute vent reminder, the reminder timer begins to count down.
- 03** Follow instructions for a Quick Release in **Releasing pressure: Venting methods**.
- 04** Wait for the float valve to drop, then carefully open and remove the lid as described in **Pressure control features: Multicooker lid**.
- 05** Using proper hand protection, remove the inner pot from the multicooker base, discard the water and thoroughly dry the inner pot.

That's it! You're good to go :)

⚠ DANGER

DO NOT attempt to remove the lid while the float valve is up and NEVER attempt to force the lid open. Contents are under extreme pressure. Float valve must be down before attempting to remove the lid. Failure to follow these instructions may result in serious personal injury and/or property damage.

⚠ CAUTION

Pressurised steam releases through the top of the steam release valve. Keep exposed skin away from the steam release valve to avoid burn injury.

⚠ CAUTION

The inner pot will be hot after cooking. Always use appropriate heat protection when handling a hot inner pot to avoid burn injury.

PRESSURE COOKING 101

Pressure cooking uses steam to raise the boiling point of water above 100°C. These high temperatures allow you to cook some foods way faster than normal.

Behind the magic curtain

When pressure cooking, the Instant Pot goes through 3 stages.

Pre-heating

What you see	What you don't see	Tips
The cooking progress bar shows Pre-heating . The display shows On .	While the multicooker pre-heats, it vaporises liquid to create steam. Once enough steam has built up, the float valve pops up and locks the lid in place.	The time it takes the multicooker to pressurise depends on things like food and liquid temperature and volume. Frozen foods have the longest pre-heating time. For the fastest results, thaw your food before cooking it.

Cooking

What you see	What you don't see	Tips
The cooking progress bar moves over to Cooking . The display switches to the cooking countdown timer.	When the Instant Pot reaches the required pressure level, cooking begins. The multicooker automatically maintains High or Low pressure throughout cooking.	A higher pressure means higher temperature. Smart Programme settings (e.g., cooking time, pressure level, etc.) can be adjusted at any time during cooking.

Depressurisation

What you see	What you don't see	Tips
If Keep Warm is on after cooking, the cooking progress bar moves over to Keep Warm , and the timer counts up from 00:00 . If not, the multicooker returns to standby and displays End .	Although food has finished cooking, the multicooker is still pressurised and hot. Venting the pressure lowers the temperature and allows you to safely remove the lid.	Follow your recipe instructions when choosing a venting method. See Releasing pressure: Venting methods on the next page for information on safe venting techniques.  Instant tip: The Instant Pot cools faster if Keep Warm is turned off!

RELEASING PRESSURE

You must release pressure after pressure cooking before attempting to open the lid.

Follow your recipe's instructions to choose a venting method, and always wait until the float valve drops into the lid before opening.

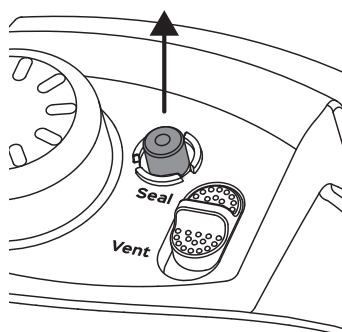

Pressurised

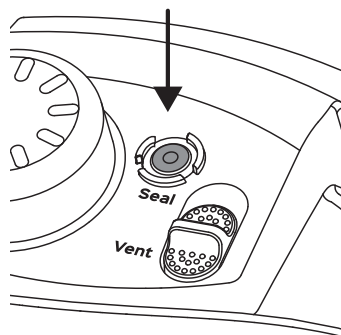

Depressurised

⚠ WARNING

Steam ejected from the steam release valve is hot. **DO NOT** place hands, face, or any exposed skin over the steam release assembly when releasing pressure to avoid injury.

Do not cover or obstruct the steam release valve or cover to avoid injury and/or property damage.

⚠ DANGER

DO NOT attempt to remove the lid while the float valve is up and NEVER attempt to force the lid open. Contents are under extreme pressure. Float valve must be down before attempting to remove the lid. Failure to follow these instructions may result in serious personal injury and/or property damage.



VENTING METHODS

- Natural Release (NR or NPR)
- Quick Release (QR or QPR)
- Timed Natural Release

RELEASING PRESSURE

Natural release (NR or NPR)

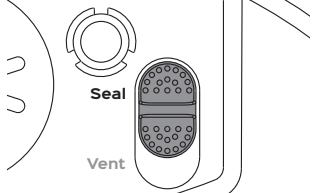
Cooking stops gradually. As the temperature within the multicooker drops, the Instant Pot Pro depressurises naturally over time.

What to do	What to expect
<p>After cooking finishes, leave the quick release switch in the Seal position until the float valve drops into the lid.</p>  <p>Seal position</p>	<p>Your meal continues to cook even after the Smart Programme ends.</p> <hr/> <p> Instant tip: This is called “carryover cooking” or “resting”, and it’s great for large cuts of meat.</p> <p>The depressurisation time may vary based upon the volume, type and temperature of food and liquid. Unless you use QuickCool™ technology, NR can take up to 40 minutes with some dishes, so plan ahead – it’s well worth the wait!</p> <p>See QuickCool to find out how to naturally release pressure faster than ever before!</p>

NOTICE

Use NR to depressurise the multicooker after cooking high-starch foods (like soups, stews, chilis, pasta, oatmeal and congee) or after cooking foods that expand when cooked (like, beans and grains).

Quick Release (QR or QPR)

Stops cooking quickly and prevents overcooking. Perfect for quick-cooking vegetables and delicate seafood!

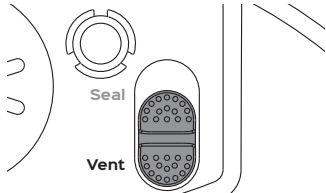
What to do	What to expect
<p>Move the quick release switch from Seal to Vent and wait until the float valve drops into the lid.</p>  <p>Vent position</p>	<p>When the steam release cover is installed properly, you’ll hear a muffled hiss as steam hits the cover and disperses.</p> <p>If the cover is not installed properly, a loud jet of steam will eject through the top of the steam release valve.</p>

RELEASING PRESSURE

NOTICE

Do not use QR when cooking fatty, oily, thick or high-starch foods (e.g., stews, chilis, pasta and congee) or when cooking foods that expand when cooked (e.g., beans and grains).

Timed Natural Release

The carryover cooking continues for a specific amount of time, then stops quickly when you release the remaining pressure. Perfect for cooking rice and grains.

What to do	What to expect
Leave the quick release switch in the Seal position for a few minutes (according to your recipe) then move it from Seal to Vent and wait until the float valve drops into the lid.	<p>When the steam release cover is installed properly, you'll hear a muffled hiss as steam hits the cover and disperses.</p> <p>If the cover is not installed properly, a loud jet of steam will eject through the top of the steam release valve.</p> <p> The temperature within the multicooker drops, so the steam release may not be as powerful as a normal QR.</p>

If you see a lot of spatter while releasing pressure, move the quick release switch back from **Vent** to **Seal**, and wait a few minutes before trying to release pressure again. If spatter continues, use NR to safely release the remaining pressure.

Vent reminder

Set a reminder for your Timed Natural Release so you can step away and own your day.

Recipe call for...	Use this reminder!
Quick Release	Off
5 minute Timed Natural Release	5 min
10 minute Timed Natural Release	10 min

CAUTION

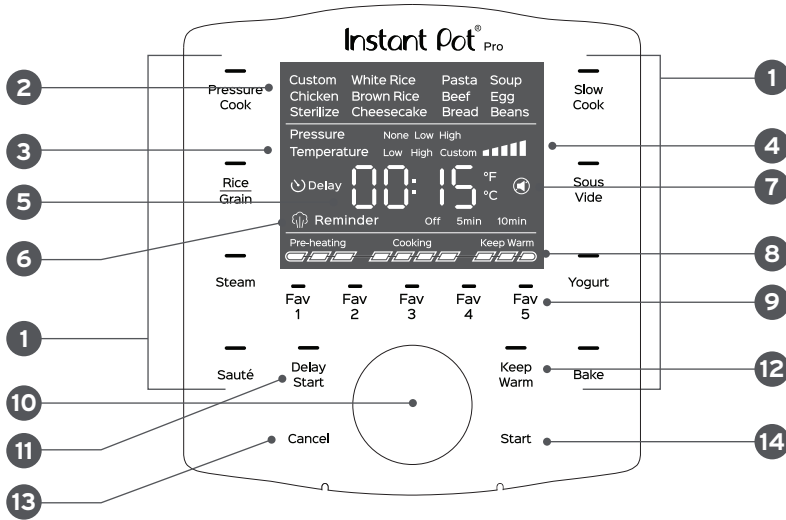

Steam ejected from the steam release valve is hot. DO NOT place hands, face, or any exposed skin over the steam release assembly when releasing pressure to avoid injury.

CONTROL PANEL



1	Smart Programmes	<ul style="list-style-type: none"> • Pressure Cook • Rice/Grain • Steam • Sauté 	<ul style="list-style-type: none"> • Slow Cook • Sous Vide • Yogurt • Bake
		See Cooking for details.	
2	Preset cooking options	After selecting a Smart Programme, choose from a variety of popular presets. All preset cooking options are customisable.	
3	Pressure	Choose between None , Low and High .	
4	Temperature	Choose between Low , High , and Custom .	
5	Time display	In standby, shows OFF . For Smart Programmes the display counts down and for Keep Warm, the display counts up. Some Smart Programmes display the temperature in °C (Celsius) or °F (Fahrenheit).	
6	Vent reminder	Only used when pressure cooking.	
7	Sounds		Sounds are on.
			Sounds are off.
		Audible safety and error message alerts cannot be turned off. See Control panel: Settings for more information.	

CONTROL PANEL

8	Cooking progress bar	Shows when the multicooker is in Pre-heating, Cooking and Keep Warm . See Control panel: Cooking progress bar for more information.
9	Fav 1 to 5	One-touch access to 5 of your favourite recipes. See Cooking: Fav 5 for more information.
10	Control dial	Turn the dial to scroll through Smart Programmes, modify status icons, and adjust the time, temperature, and pressure levels.  The dial is also a button. Press the dial to confirm your selections.
11	Delay Start	Delay the start of cooking. Doubles as a kitchen timer!
		 Icon appears when Delay Start timer is counting down.
12	Keep Warm	Turns Keep Warm on or off.  Can only be used with Pressure Cook, Rice and Slow Cook, or as a standalone programme when in standby.
13	Cancel	Stops a Smart Programme at any time and returns the multicooker to standby.
14	Start	Begins the selected Smart Programme.

COOKING PROGRESS BAR





1	Preheating	Pre-heating is in progress. The display shows On during the pre-heating stage to let you know that it's working on getting up to temperature.
2	Cooking	Cooking starts after the Pro reaches the target pressure or temperature required by the Smart Programme. The display counts down the remaining cooking time.
3	Keep Warm	Keep Warm comes on automatically after cooking finishes to keep your meal at serving temperatures. The timer counts up the elapsed time to a maximum of 10 hours (10:00). When Keep Warm completes, the display shows End .

STATUS MESSAGES

OFF	The Pro is in standby mode, ready to make your next favourite meal.
On	The multicooker is Pre-heating .
Hot	The inner pot has reached the perfect cooking temperature and food can be added.  Only applies to Sauté and Sous Vide.
00:15	The display shows one of the following: <ul style="list-style-type: none"> • The remaining Cooking time when a Smart Programme is running, • The Delay Start countdown, • How long food has been in Keep Warm.
boil	The Yogurt Smart Programme is set to pasteurisation mode. See Cooking: Yogurt for more information.
149°F	Displays when you're setting up Sous Vide cooking to show the default temperature setting. To set a custom cooking temperature, turn the dial when the temperature flashes. Then press the dial to make your selection.
SEt2	Displays when you press a Fav key to save a Favourite recipe.
3tbd	Displays when you press a Fav key that hasn't been saved as a Favourite. Number will change between 1-5 depending on the missing Fav setting selected.
End	When cooking finishes, the display shows End until you remove the lid or touch Cancel .

Do you see something else? See **Troubleshooting** for more information.

SETTINGS

Setting	Description				
Change displayed temperature (°C and °F).	In standby, press and hold the dial for 5 seconds. When the temperature unit flashes, turn the dial to toggle between °C and °F, then press Start to save the change.				
Turn sound on or off.	In standby, press and hold the dial for 5 seconds. When the temperature unit flashes, press the dial to go to the sound field. When the sound icon flashes, turn the dial to toggle the sound on and off, then press Start to save the change.  Audible safety and error message alerts cannot be turned off.				
Adjust and save custom cooking times and temperatures.	Changes to the cooking time, temperature and pressure level are saved once the Smart Programme begins. See Cooking for more information.				
On-the-fly changes to cooking settings.	Once a Smart Programme has started, press the dial to enter the cooking settings. Turn the dial to adjust settings, then press the dial to confirm your changes and go to the next field. When you're happy with the settings, touch Start to confirm your changes and resume cooking.  Changes made during cooking are not saved to memory.				
Delay the start of cooking.	<table border="1" data-bbox="462 1067 1090 1169"> <thead> <tr> <th>Default time</th> <th>Time range</th> </tr> </thead> <tbody> <tr> <td>6 hours (06:00)</td> <td>10 minutes to 24 hours (00:10 to 24:00)</td> </tr> </tbody> </table> <p>Select and set up an applicable Smart Programme. After programming the Smart Programme, touch Delay Start. When the time flashes, turn the dial to adjust the delay time as needed. Touch Start to begin the delay countdown.  Delay Start cannot be used with Sauté, Yogurt, Sous Vide or Steam.</p>	Default time	Time range	6 hours (06:00)	10 minutes to 24 hours (00:10 to 24:00)
Default time	Time range				
6 hours (06:00)	10 minutes to 24 hours (00:10 to 24:00)				

SETTINGS

Setting	Description
Reset an individual Smart Programme.	<p>When in standby, touch and hold the Smart Programme button you want to reset for 5 seconds.</p> <p>The Smart Programme's cooking time, pressure level and/or temperature are restored to the factory default setting.</p> <p> The Fav 5 programme's cannot be reset individually.</p>
Reset all Smart Programmes.	<p>When in standby, touch and hold Cancel until the multicooker beeps.</p> <p>All Smart Programme cooking times, pressure levels and/or temperatures are restored to factory default settings.</p>

PRESSURE CONTROL FEATURES

See **Care, cleaning and storage** for installation and removal of parts.

MULTICOOKER LID

What we love about it	What you should know about it
<p>When you close the lid (over the handles on the new inner pot!), it automatically sets to Seal for <i>seriously</i> easy pressure cooking.</p> <p>The lid handle is comfortable to use whether you're left or right-handed, and, stands up in the multicooker base!</p> <p>When it's plugged in, the Pro plays a little jingle when you open and close the lid. :)</p>	<p>The lid is removable during non-pressure cooking so you can taste-test as you go.</p> <p>When pressure cooking, the lid only locks into place once the multicooker has pressurised. Try not to remove the lid unnecessarily!</p>

Removing the lid

- 01** Grip the lid handle and turn it counter-clockwise to align the symbol on the lid ▼ with the symbol on the rim of the multicooker base ■.
- 02** Lift the lid up and off the multicooker base towards your body.

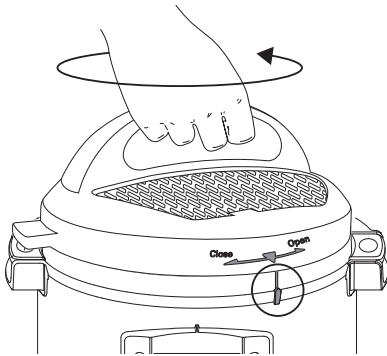

See **Releasing pressure: Venting methods** for safe depressurisation techniques.

Closing the lid

- 01** Align the symbol on the lid ▼ with the symbol on the multicooker base ■, then lower the lid onto the track.
- 02** Turn the lid clockwise until the symbol on the lid ▼ aligns with the middle of the control panel.

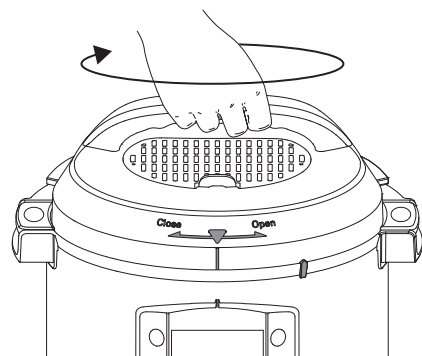

Illustrations in this document are for reference only and may differ from the actual product. Always refer to the actual product.

PRESSURE CONTROL FEATURES

QUICKCOOL™

For the fastest Natural Release after pressure cooking, use the QuickCool tray*.

What we love about it	What you should know about it
It's a huge timer saver – you can release pressure naturally up to 50% faster!	The metal portion of the lid gets extremely hot, so don't remove the protective cover unless you're using QuickCool.

To use the QuickCool tray, fill it with ice or water and freeze it. Once frozen, remove the protective cover from the multicooker lid, and position the QuickCool tray on the exposed metal of the lid.

When the float valve drops into the lid, remove the QuickCool tray, discard the water and open the lid. Use caution when removing the tray as some or all of the ice may have melted.

*QuickCool tray sold separately.

⚠ CAUTION

The lid will be hot during and after cooking. Do not touch the exposed metal with bare skin to avoid injury.

QUICK RELEASE SWITCH

The quick release switch controls the steam release valve – the part that releases pressure.

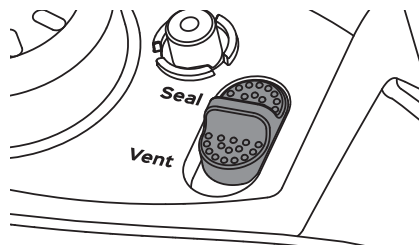

What we love about it	What you should know about it
It's <i>super</i> easy to use, and keeps our hands far away from the steam when the multicooker is releasing pressure!	It automatically sets to Seal when you close the lid, so make sure to move it to Vent when you're not pressure cooking.

PRESSURE CONTROL FEATURES

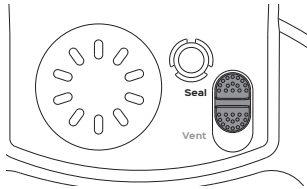

Seal Position

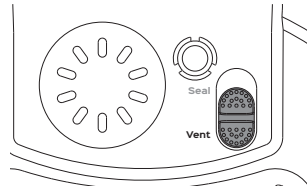

Vent Position

See **Releasing pressure: Venting methods** for safe depressurisation techniques.

STEAM RELEASE ASSEMBLY

The steam release assembly must be fully installed before use.

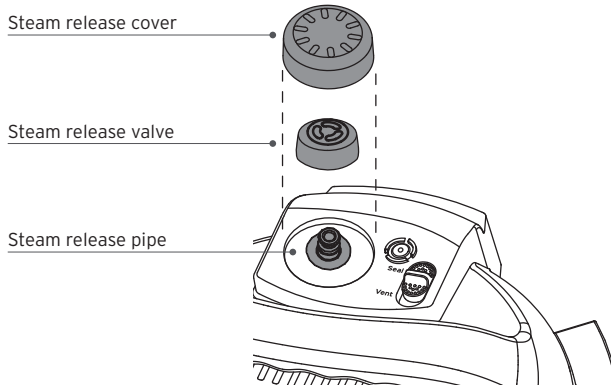

What we love about it	What you should know about it
When the valve is venting, the steam release cover disperses the steam, so the quick release of pressure is soft and gentle.	When releasing pressure, steam travels up from the inner pot, through the steam release pipe and out from the top of the steam release valve – so it's important to keep the area clean and clear. The steam release valve sits loosely on the steam release pipe.

⚠ WARNING

Do not cover or block the steam release assembly in any way to avoid injury and/or property damage.

PRESSURE CONTROL FEATURES

ANTI-BLOCK SHIELD

The anti-block shield prevents food particles from coming up through the steam release pipe, which assists with pressure regulation.

The anti-block shield is integral to product safety and necessary for pressure cooking, so it must be installed before use.

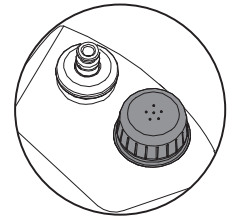



SEALING RING

When the multicooker lid is closed, the sealing ring creates an airtight seal between the lid and the inner pot.

The sealing ring must be installed before use.

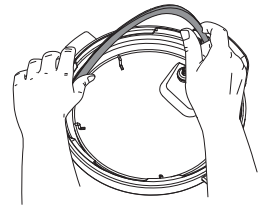
Only one sealing ring should be installed in the lid at a time.



 **Instant Tip:** Silicone is porous, so it absorbs strong aromas and certain flavours. Keep extra sealing rings on hand to limit the transfer of those aromas and flavours between dishes.

CAUTION

Always check for cuts, deformation and correct installation before cooking, as sealing rings stretch over time with normal use. If you notice stretching, deformation, or damage to your sealing ring, DO NOT use it.

Replace the sealing ring every 12 to 18 months or sooner, and only use authorised Instant Pot sealing rings.

Failure to follow these instructions may cause food to discharge, which may lead to personal injury or property damage.

PRESSURE CONTROL FEATURES

FLOAT VALVE

The float valve lets you know when there is pressure in the multicooker (pressurised) or not (depressurised). It appears in 2 positions:

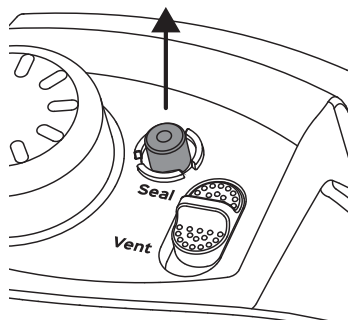

Pressurised

The float valve has visibly popped up above the surface of the lid.

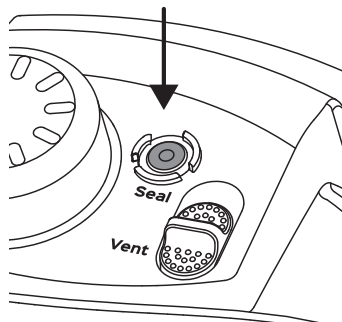

Depressurised

The float valve has descended, and the top is flush with the lid or below.

The float valve and silicone cap work together to seal in pressurised steam. These parts must be installed before use. Do not attempt to operate the Instant Pot without the float valve properly installed. **Do not touch the float valve during use.**

⚠ DANGER

DO NOT attempt to remove the lid while the float valve is up and NEVER attempt to force the lid open. Contents are under extreme pressure. Float valve must be down before attempting to remove the lid. Failure to follow these instructions may result in serious personal injury and/or property damage.

COOKING

The Instant Pot Pro is amazingly versatile in the kitchen. No matter what kind of cooking you want to do, the Pro has you covered.

CAUTION

Always inspect the **lid** and **inner pot** carefully to make sure they are clean and in good working condition before use.

- To avoid personal injury or damage to the appliance, replace the inner pot if it is dented, deformed, or damaged.
- Use only authorised Instant Pot inner pots made for this model when cooking.

Always make sure the heating element is clean and dry before inserting the inner pot into the multicooker base.

Failure to follow these instructions may damage the multicooker. Replace damaged parts to make sure safe function.

WARNING

DO NOT fill inner pot higher than the **Max PC Fill** line as indicated on the inner pot to avoid personal injury and/or property damage.

When cooking foods that expand (e.g., rice, beans, pasta) do not fill the inner pot higher than the **Half Fill** line as indicated on the inner pot.

Always cook with the inner pot in place. DO NOT pour food or liquid into the multicooker base.

To avoid risk of personal injury and/or property damage, place food and liquid ingredients in the inner pot, then insert the inner pot into the multicooker base.

CAUTION

When cooking meat, always use a meat thermometer to ensure the internal temperature reaches a safe minimum temperature.

COOKING

SMART PROGRAMME OVERVIEW

Smart Programme	Cooking presets	Pressure levels	Tips
Pressure Cook	Custom, Chicken, Sterilise, Pasta, Beef, Soup, Egg, Beans	Low High	It is recommended to use timed Natural Release or follow recipes for the best outcome.
Rice/Grain	Custom, White Rice, Brown Rice	Low High	
Steam	Custom	–	This is a non-pressure steam programme which is great for cooking delicate food, like zucchini and broccoli.
Sauté	Custom	–	Level 1 to 5 works like your stovetop sauté pan where 5 is the highest heat for browning, and 1 is the lowest heat for simmer.
Slow Cook	Custom, Chicken, Beef, Beans, Soup	–	Works just like a traditional slow cooker. Ensure cooking time is set to 4 hours or more for optimal result. Caution: Cooking less than 3 hours will result in uncooked food.
Sous Vide	Custom, Chicken, Beef, Egg	–	
Yogurt	Custom	–	
Bake	Custom, Cheesecake, Bread	None Low High	
Keep Warm	–	Custom, Low High.	

COOKING

PRESSURE COOK AND RICE

Jump start magic! These programmes use pressurised steam to cook food quickly, evenly, and deeply, for delicious results every time!

For the best pressure cooking results, always follow an authorised Instant Pot recipe or our tried, tested and true pressure cooking timetables which feature grain-to-water ratios for making a variety of rice and grains.

Choose from 3 pressure levels, depending on the Smart Programme.

Pressure level	Suggested use	Notes
Low 5.8 - 7.2 psi (30 - 50 kPa)	Fish and seafood, soft vegetables and rice. Also for canning of high-acid foods.	When pressure cooking, the pressure level controls the cooking temperature, so a higher pressure results in a higher cooking temperature.
High 10.2 - 11.6 psi (70 - 90 kPa)	Eggs, meat, poultry, root vegetables, oats, beans, grains, bone broth, stew, chili.	

Pressure cooking liquids should be water-based, such as broth, stock, soup or juice. If using canned, condensed or cream-based soup, add liquid as directed below.

Instant Pot size	Minimum liquid for pressure cooking*
5.7 Litres	1 ½ cups (375 mL)
8 Litres	2 cups (500 mL)

*Unless otherwise specified in recipe.

 **Instant Tip:** Use the steam rack to heat food evenly, prevent nutrients from leeching into the cooking liquid, allow oil and grease to drip off the food, and, prevent food from scorching the bottom of the inner pot.

CAUTION

To avoid scorching or scalding injury, be cautious when pressure cooking with more than 1/4 cup (60 mL) oil, oil-based sauces, condensed cream-based soups, and thick sauces. Add suitable liquid to thin sauces. Avoid recipes that call for more than 1/4 cup (60 mL) of oil or fat content.

COOKING

PRESSURE COOK AND RICE

Smart Programme	Cooking presets	Default pressure	Default cooking times	Time range
Pressure Cook	Custom	High	10 minutes (00:10)	1 minute to 8 hours (00:01 to 08:00)
	Pasta	High	1 minute (00:01)	1 minute to 1 hour (00:01 to 01:00)
	Soup	High	30 minutes (00:30)	1 minute to 4 hours (00:01 to 04:00)
	Chicken	High	10 minutes (00:10)	
	Beef	High	30 minutes (00:30)	
	Beans	High	20 minutes (00:20)	
	Egg	High	5 minutes (00:05)	1 minute to 10 minutes (00:01 to 00:10)
	Sterilise	High	10 minutes (00:10)	1 minute to 30 minutes (00:01 to 00:30)
Rice/Grain	Custom	Low	12 minutes (00:12)	1 minute to 1 hour (00:01 to 01:00)
	Brown Rice	High	30 minutes (00:30)	
	White Rice	Low	12 minutes (00:12)	1 minute to 30 minutes (00:01 to 00:30)

Stage 1: Setting up the Pro for pressure cooking

- 01 Add food and liquid to the inner pot as indicated in your recipe.
Insert the inner pot into the multicooker base.
- 02 Place and close the multicooker lid as described in **Pressure control features: Multicooker lid**.

Stage 2: Pressure cooking

- 01 Touch the Smart Programme you want to use: **Pressure Cook** or **Rice**.
- 02 When **Custom** flashes, turn the dial to toggle through the preset cooking options.
Press the dial to make your selection and go to the next field.
- 03 When the pressure level flashes, turn the dial to toggle through the options.
Press the dial to confirm your choice and go to the next field.

COOKING

PRESSURE COOK AND RICE

04 When the time flashes, turn the dial to adjust the cook time as directed by your recipe.

Press the dial to confirm the change and go to the next field.

 Customisations are saved to the Smart Programme when cooking begins.

05 When **Reminder** flashes, turn the dial to toggle between vent reminder options. See **Control panel** for more information.

Press the dial to confirm your choice.

06 Touch **Start** to begin.

The display shows **On** and the cooking progress bar shows **Pre-heating**.

Stage 3: Releasing pressure

When **Cooking** finishes, the display shows **End** if Keep Warm is turned off.

If Keep Warm is on, the timer begins counting from **00:00** up to 10 hours (**10:00**).

 Food should not be kept warm for more than 10 hours. If cooking thick or starchy foods, heat may not dissipate evenly. To ensure food safety, stir the contents of thicker dishes every 40 to 60 minutes.

If you have set a 5 or 10 minute vent reminder, the reminder timer begins to count down.

01 When you're ready, follow your recipe's instructions to choose a venting method.

See **Releasing Pressure** for information on safe venting techniques

02 Wait for the float valve to drop, then carefully open and remove the lid as described in **Pressure control features: Multicooker lid**.

03 Using proper hand protection, remove the inner pot from the multicooker base, discard the water and thoroughly dry the inner pot.

A delay start timer can be set to automatically start pressure cooking while you're in bed, working, running errands or busy with other dishes. To set a delay start timer, see **Control panel: Settings**.

COOKING

STEAM (NON-PRESSURISED)

The Steam programme works in 2 ways: like a regular stovetop steamer, boiling liquid to cook food with hot steam, and, as a sanitisation chamber for glass and plastics.

Note: please refer to manufacturer's instruction on the time and temp for sanitisation.

 Instant tip: When steaming, use the steam rack to keep food out of the boiling liquid.

Smart Programme	Cooking presets	Default temperature	Default cooking times	Temperature range	Time range
Steam	Custom	High	30 minutes (00:30)	Low 83°C	1 minute to 1 hour (00:01 to 01:00)
		Low		High 100°C (Not adjustable)	

CAUTION

The inner pot and accessories will be hot during and after cooking. Always use appropriate hand protection when adding to or removing food from a hot inner pot to avoid injury and/or property damage.

NOTICE

The float valve should not rise during Steam. If the float valve rises, make sure the quick release switch is set to **Vent**.

NOTICE

If there is steam in the inner pot, you may notice some resistance when replacing the lid. Allow the lid to settle into the track completely before closing it.

COOKING

STEAM

Stage 1: Setting up the Pro for steaming

- 01** Add water to the inner pot.

Insert the inner pot into the multicooker base.

- 02** Place steam rack in inner pot and add food on top.

- 03** Place and close the multicooker lid as described in **Pressure control features: Multicooker lid**.

-  For easy access, or, if you want to watch your food while it cooks, any glass lid with a venting hole will do.

Stage 2: Steam cooking

- 01** Touch **Steam**.

- 02** When **Custom** flashes, turn the dial to toggle through the preset cooking options.

Press the dial to make your selection and go to the next field.

- 03** When the temperature flashes, turn the dial to toggle between **High** and **Low** temperature.

Press the dial to make your selection and go to the next field.

- 04** When the time flashes, turn the dial to adjust the cooking time.

- 05** Touch **Start** to begin.

The display shows **On** and the cooking progress bar shows **Pre-heating**.

- 06** When the Pro reaches the target temperature, the progress bar moves over to **Cooking** and the timer counts down.

- 07** When the Smart Programme finishes the display shows **End**.

Automatic Keep Warm cannot be used with Steam.

-  The use of the steam rack or other Instant Pot authorised accessories are recommended for steaming.

COOKING

SAUTÉ

Like using a frying pan, griddle, or flat-top grill, use Sauté to simmer, reduce and thicken liquids, stir-fry meals, and to caramelize vegetables and sear meat before or after using other cooking methods.

 **Instant Tip:** If you prefer, you can use the inner pot on any electric, ceramic, gas and induction cooktop. The silicone Easy Grip handles make it easy to hold on to and stir without slipping!

Smart Programme	Cooking preset	Default temperature	Default cooking time	Temperature range	Time range
Sauté	Custom	High	30 minutes (00:30)	Custom Low High	1 minute to 1 hour (00:01 to 01:00)

Stage 1: Setting up the Pro for Sauté

- 01** Insert the inner pot into the multicooker base. **Do not use a lid.**
- 02** Touch **Sauté**.
- 03** When **Custom** flashes, press the dial to select it and go to the next field.
- 04** When the temperature flashes, turn the dial to toggle between **High**, **Low** and **Custom** temperature.
To set a custom temperature, select **Custom**, then turn the dial to toggle through 5 temperature levels. The display shows **LE 1** (the lowest temperature) through **LE 5** (the highest temperature). These levels are similar to the temperature levels on your stovetop.
Press the dial to make your selection and go to the next field.
- 05** When the time flashes, turn the dial to adjust the cooking time.
- 06** Touch **Start** to begin.
The display shows **On** and the cooking progress bar shows **Pre-heating**.

Stage 2: Sautéing

- 01** When the Pro reaches the target temperature the progress bar moves over to **Cooking** and the display shows **Hot** for a few moments before switching over to the countdown timer.
- 02** Add ingredients to the inner pot.
 If your food ingredients are added before the inner pot has reached the target temperature, the Hot message may not appear. This is normal.
- 03** If the ingredients are finished cooking before the time runs out, touch **Cancel** to end the Smart Programme, otherwise, when the Smart Programme finishes the display shows **End**.

Automatic Keep Warm is not available on Sauté.

Delay Start and automatic Keep Warm cannot be used with Sauté.

COOKING

DEGLAZING

Sautéing meat and vegetables before pressure cooking is the perfect way to boost flavours, as sugars caramelize from the high heat of the Sauté Smart Programme. Deglazing the inner pot lets you unlock those flavours in amazing sauces, gravies and more.

To deglaze, remove food items from the inner pot and add a thin liquid, like water, broth or wine to the hot surface. Use a wooden or silicone scraper to lift up any food stuck to the bottom of the inner pot and stir it into the liquid.

WARNING

The Sauté Smart Programme reaches high temperatures. If left unmonitored, food may burn on this setting. **DO NOT** use a lid and **DO NOT** leave the multicooker unattended while using Sauté.

COOKING

SLOW COOK

The Slow Cook programme is comparable to a traditional slow cooker, so you can keep using all your old family favourites!

Smart Programme	Cooking presets	Default temperature	Default cooking times	Time range	Tips
Slow Cook	Custom	High	4 hours (04:00)	30 minutes to 99 hours and 30 minutes (00:30 to 99:30)	Dishes should cook for at least 3 hours (03:00) unless otherwise stated in your recipe.
	Chicken	High	6 hours (06:00)		
	Beef	High			
	Soup	High	8 hours (08:00)		
Beans	High				

Stage 1: Setting up the Pro for slow cooking

- 01** Add food and liquid ingredients to the inner pot according to your recipe. Insert the inner pot into the multicooker base.
- 02** Place and close the multicooker lid as described in **Pressure control features: Multicooker lid**.

 The multicooker lid is removable throughout the cooking process for easy access, or, if you want to watch your food while it cooks, any glass lid with a venting hole will do.

Stage 2: Slow cooking

- 01** Touch **Slow Cook**.
- 02** When **Custom** flashes, turn the dial to toggle through the preset cooking options.
Press the dial to make your selection and go to the next field.

03 When the temperature flashes, turn the dial to toggle between **High** and **Low** temperature.

Press the dial to make your selection and go to the next field.

04 When the time flashes, turn the dial to adjust the cooking time.

05 Touch **Start** to begin.
The progress bar shows **Pre-heating** and the timer starts counting down immediately.

06 When the Pro reaches the target temperature the progress bar moves over to **Cooking**.

07 When **Cooking** finishes, the display shows **End** if Keep Warm is turned off.

If Keep Warm is on, the timer begins counting from **00:00** up to 10 hours (**10:00**).

A delay start timer can be set to automatically start slow cooking while you're in bed, working, running errands or busy with other dishes. To set a delay start timer, see **Control panel: Settings**.

NOTICE

The float valve should not rise during Slow Cook. If the float valve rises, move the quick release switch to **Vent**.

COOKING

SOUS VIDE

Sous Vide cooking involves cooking food underwater, in an airtight, food-safe bag, for a long period of time. Food cooks in its own juices and comes out delicious and unbelievably tender.

CAUTION

Do not overfill the inner pot to avoid damage to the multicooker. Total contents (water and food pouches) should leave at least 5 cm of headspace between the water line and the brim of the inner pot.

Smart Programme	Cooking presets	Default temperature	Default cooking times	Time range
Sous Vide	Custom	60°C	3 hours (03:00)	30 minutes to 99 hours and 30 minutes (00:30 to 99:30)
	Chicken	60°C	2 hours (02:00)	10 minutes to 99 hours and 30 minutes (00:10 to 99:30)
	Beef	54°C	2 hours (02:00)	
	Egg	70°C	30 minutes (00:30)	10 minutes to 24 hours (00:10 to 24:00)

You'll need:

- Tongs
- Thermometer
- Food safe, airtight, re-sealable food pouches, or,
- Vacuum sealer and food-safe vacuum bags

COOKING

SOUS VIDE

Step 1: Set up the sous vide water bath

01 Fill the inner pot to the **Half Fill** mark as indicated the pot, then insert it into the multicooker base.

02 Place and close the multicooker lid as described in **Pressure control features: Multicooker lid**.

 The multicooker lid is removable throughout the cooking process for easy access.

Step 2: Setting up the Pro for sous vide cooking

01 Touch **Sous Vide**.

02 When **Custom** flashes, turn the dial to toggle through the preset cooking options.

Press the dial to make your selection and go to the next field.

03 When the temperature flashes, turn the dial to set a custom temperature.

Press the dial to make your selection and go to the next field.

04 When the time flashes, turn the dial to adjust the cooking time.

05 Touch **Start** to begin.

The display shows **On** and the progress bar shows **Pre-heating**.

Step 3: Get food ready

01 While the water heats, start by seasoning your food as desired. See **Ingredients and Seasonings** on next page for tips!

02 When you're ready, separate each serving of food into individual pouches.

03 Remove all air from the pouches and seal them tightly.

Step 4: Cook 'em up!

01 Once the water bath is ready, the display shows **Hot** for a few moments before switching over to the countdown timer.

02 Remove the lid and carefully immerse the sealed pouches.

 The food in the pouches should be immersed, so add heated water to the inner pot any time it's needed, but, if you're using a re-sealable bag, make sure the seal stays above the water.

03 Place and close the multicooker lid as described in **Pressure control features: Multicooker lid**.

04 When the Smart Programme finishes the display shows **End**. Open the multicooker and use your tongs to carefully remove the pouches from the hot water.

05 Open the pouches and use a thermometer to check for doneness.

COOKING

REVERSE SEARING

Searing your meat after slow and precise cooking is the easiest way to boost those already delicious flavours through the roof without overcooking. Try reverse searing for tender, juicy meat with a beautiful, burnished crust.

- 01** After sous vide cooking, remove the meat from the cooking pouch and gently pat it dry to remove as much moisture from the exterior of the meat.
 - 02** Use the Sauté programme set to High to give it a good sear, or use a hot cast iron pan, browning torch, or a grill – anything hot to lock in that moisture!
-  In general, after sautéing, steaks need to rest to allow the internal temperature to even out. However, with sous vide cooking, the internal temperature is already consistent. So there's no need to rest—you can serve your steak immediately.

INGREDIENTS AND SEASONINGS

- Salt goes a long way when it has nowhere to go, so it's better to use a little less than you normally would, especially with meats, poultry, and fish. If you find it needs more after cooking, it's easy to salt to taste.
- Use high quality, fresh ingredients when cooking sous vide to ensure the best possible flavour.
- Use fresh garlic instead of garlic powder. Garlic powder can become bitter when cooked sous vide. Fresh garlic will give you the best results.

COOKING

SOUS VIDE COOKING CHART

Food	Recommended Thickness	Expected Doneness	Cooking Temperature*	Minimum Cooking Time*	Maximum Cooking Time*
Beef and Lamb					
Tender Cuts: Tenderloin, cutlets, sirloin, rib-eye, rump, T-bone, chops	2-5 cm	Rare	50°C	1 hour	4 hours
		Medium-rare	54°C	1.5 hours	4 hours
Tougher Cuts: Blade, chuck, shoulder, shanks, game meats	4-6 cm	Medium	60°C	1.5 hours	4 hours
		Medium-well	63°C	1.5 hours	4 hours
Poultry					
Chicken Breast	3-5 cm	Soft and Juicy	63°C	1.5 hours	4 hours
		Traditionally firm	69°C	1 hour	4 hours
Chicken Thigh	3-5 cm	Juicy and tender	74°C	1 hour	4 hours
		Off-the-bone tender	74°C	4 hours	8 hours
Chicken Leg	5-7 cm	Juicy and Tender	74°C	2 hours	7 hours
Duck Breast	3-5 cm	Soft and Juicy	64°C	2 hours	4 hours
Pork					
Belly	3-6 cm	Traditionally firm	82°C	10 hours	22 hours
Ribs	2-3 cm	Off-the-bone tender	59°C	10 hours	22 hours
Chops	2-4 cm	Pink and juicy	57°C	1 hour	4 hours
		White throughout and juicy	64°C	1 hour	4 hours

COOKING

SOUS VIDE COOKING CHART

Food	Recommended Thickness	Expected Doneness	Cooking Temperature*	Minimum Cooking Time*	Maximum Cooking Time*
Fish and Seafood					
Fish	2-3 cm	Soft and buttery	43°C	10 minutes	30 minutes
		Translucent / starts to flake	46°C	20 minutes	45 minutes
		Medium-rare	52°C	20 minutes	45 minutes
		Medium, dry	54°C	20 minutes	45 minutes
		Well-done, crumbly	57°C	20 minutes	45 minutes
Shrimp	-	Traditionally firm	60°C	30 minutes	45 minutes
Lobster Tail	-	Soft and buttery	60°C	1 hour	1 hour
Scallops	-	Soft and buttery	60°C	30 minutes	30 minutes
Eggs					
Eggs	Large / Extra Large	Runny	60°C	-	45 minutes
		Soft boiled	63°C	-	45 minutes
		Medium boiled	66°C	-	1 hour
		Hard boiled	73.9°C	-	1 hour
Fruits and Vegetables					
Fruits	-	-	83.9°C	15 minutes	2 hours
Vegetables	-	-	83.9°C	45 minutes	2.5 hours

*Cooking times and temperatures are recommendations only. Always refer to a trusted recipe.

COOKING

YOGURT

Made for easy fermenting dairy and non-dairy yogurt recipes that you can make again and again.

Instant Pot size	Minimum milk volume	Maximum milk volume
5.7 Litres	4 cups (1 L)	~3.8L
8 Litres	6 cups (1.5 L)	~5.7L

Smart Programme	Cooking presets	Default temperature	Default cooking time	Time range
Yogurt	Custom	Low (Ferment)	8 hours (08:00)	30 minutes to 99 hours and 30 minutes (00:30 to 99:30)
		High (Pasteurise)	(boil)	Will take 30 minutes to 1 hour depending on the amount of milk
		Custom 56°C	8 hours (08:00)	30 minutes to 99 hours and 30 minutes (00:30 to 99:30)

Starting with...	Do this!
Pasteurised or unpasteurised milk	Follow all the steps below
Ultra-pasteurised milk	Skip to Step 2: Add starter culture. This is the "cold start" method of yogurt making.

You'll Need:

- Food Thermometer
- Milk or a non-dairy alternative
- Active yogurt culture

COOKING

YOGURT

Step 1: Pasteurise milk

01 Add milk or milk alternative to the inner pot, and any other ingredients that your recipe calls for.

02 Place and close the multicooker lid as described in **Pressure control features: Multicooker lid**.

 The multicooker lid is removable throughout yogurt making for easy access.

03 Touch **Yogurt**.

04 When the temperature flashes, turn the dial to toggle to **High**.

 The pasteurisation time and temperature are preset and cannot be adjusted.

05 Touch **Start** to begin.

The display shows **boil** and the progress bar shows **Pre-heating**.

06 The display shows **End** when pasteurisation is complete.

Milk must reach a minimum of 72°C to pasteurise properly. Use a thermometer to check the temperature.

Step 2: Add starter culture

01 Using a thermometer, allow the milk to cool to just below 43°C.

02 Add your starter culture to the milk according to the instructions included with the starter culture product.

 Plain yogurt with active cultures can be used as a starter. Follow a trusted Instant Pot yogurt recipe when using yogurt as a starter culture.

03 Place and close the multicooker lid as described in **Pressure control features: Multicooker lid**.

Step 3: Ferment milk

01 Touch **Yogurt**.

02 When the temperature flashes, turn the dial to toggle to **Low** or **Custom**. To set a custom temperature, select **Custom**, then turn the dial to set the temperature.

Press the dial to make your selection and go to the next field.

03 When the time flashes, turn the dial to adjust the cooking time.

 An 8-hour fermentation period is standard, but may vary based on your recipe and flavour preferences.

04 Touch **Start** to begin.

The display shows **On** and the progress bar shows **Pre-heating**.

05 When fermentation is complete the display shows **End**.

COOKING

YOGURT

Tips for yogurt making

- The thicker the milk, the thicker the yogurt!
- For even thicker yogurt, pasteurise your milk twice before fermenting.
- For the thickest yogurt, use a cheesecloth to strain out the liquid whey, and get rich Greek-style yogurt.
- The longer you ferment your milk, the tangier the yogurt will be.
- Cool your fresh yogurt, then put it in the fridge (covered) for 12 to 24 hours to allow the flavours to develop.
- Honey, nuts, seeds and fresh fruit are perfect toppers for your homemade yogurt!

USING YOGURT CUPS

Yogurt cups are a convenient way to portion out yogurt servings.

- 01** After **Step 2: Add started culture**, carefully pour the milk into your yogurt cups and seal them tightly.
- 02** Place the steam rack on the bottom of the inner pot.
- 03** Position the yogurt cups on the rack and add water to the inner pot until the cups are immersed halfway.
- 04** Follow the steps in **Step 3: Ferment yogurt** normally.

COOKING

BAKE

Use Bake with or without pressure to proof dough and create decadent brownies, moist banana bread, and other tasty treats.

Smart Programme	Cooking presets	Default temperature or pressure	Default cooking time	Time range
Bake	Custom	None, 176°C	30 minutes (00:30)	1 minute to 4 hours (00:01 to 04:00)
	Cheesecake	High	45 minutes (00:45)	1 minute to 1 hour (00:01 to 01:00)
	Bread	High	40 minutes (00:40)	

Stage 1: Setting up the Pro for baking

- 01 Place the steam rack on the bottom of the inner pot, then place your baking dish on top of the steam rack.
 Leave approximately 2.5 cm of space around all sides of the baking dish to allow heat to circulate evenly.
- 02 Insert the inner pot into the multicooker base.
- 03 Place and close the multicooker lid as described in **Pressure control features: Multicooker lid**.

Stage 2: Baking

- 01 Touch **Bake**.
- 02 When **Custom** flashes, turn the dial to toggle through the preset cooking options.
Press the dial to make your selection and go to the next field.
- 03 When the pressure level flashes, turn the dial to toggle through **None**, **Low** and **High**.
If you choose **None**, turn the dial to set a custom temperature.
Press the dial to confirm your choice and go to the next field.

- 04 When the time flashes, turn the dial to adjust the cook time as directed by your recipe.

Press the dial to confirm the change and go to the next field.

- 05 **Reminder** flashes if you're cooking with pressure.

Turn the dial to toggle between vent reminder options. See **Control panel** for more information.

- 06 Touch Start to begin.

The display shows **On** and the cooking progress bar shows **Pre-heating**.

Stage 3: Releasing pressure

- 01 When **Cooking** finishes, the display shows **End**.
- 02 If you have set a 5 or 10 minute vent reminder, the reminder timer begins to count down.
- 03 When you're ready, follow your recipe's instructions to choose a venting method.

See **Releasing Pressure** for information on safe venting techniques.

COOKING

- 04** If baking with pressure, wait for the float valve to drop, then carefully open and remove the lid as described in **Pressure control features: Multicooker lid.**
- 05** Using proper hand protection, remove the inner pot from the multicooker base and carefully lift out your baking dish.

KEEP WARM

Perfect to reheat meals or warm food for long periods of time.

Smart Programme	Default temperature	Temperature range	Time range
Keep Warm	High	Custom 62 to 90°C	30 minutes to 10 hours (00:30 to 10:00)
		Low 62°C	
		High 77°C	

- 01** Touch **Keep Warm**.
- 02** When the temperature flashes, turn the dial to toggle to **Low**, **High**, or **Custom**.
To set a custom temperature, select **Custom**, then turn the dial to set the temperature.
Press the dial to make your selection and go to the next field.
- 03** When the time flashes, turn the dial to adjust the cooking time.
To set a custom temperature, touch the **Temperature field** to toggle to **Custom**, then turn the dial to choose a temperature.
- 04** Touch Start to begin. The display shows **On** and the progress bar shows Pre-heating.
- 05** When Keep Warm completes, the display shows **End**.

CAUTION

Thicker foods may prevent even heating, which can lead to spoiled food if left unattended. When keeping warm food like stew and chili, stir the contents of the inner pot every 40 to 60 minutes to make sure that heat is evenly distributed.

USING FAVOURITE PROGRAMMES

Set and save 5 custom programmes as Favourites for one-touch access to recipes.



SAVING RECIPES AS FAVOURITES

- 01 Select any Smart Programme and set it up according to your recipe.
- 02 When you're happy with the settings, touch and hold any Fav key for 3 seconds to save the programme.

That's it! Your customised programme is ready to use any time you want.

 You can replace a saved Favourite with a new recipe by repeating these steps again.

USING FAVOURITE RECIPES

Depending on your recipe, you can add your ingredients to the inner pot before or after Pre-heating.

- 01 Touch the **Fav** key you want to use.
- 02 Touch **Start** to begin.

The display shows **On** and the progress bar shows **Pre-heating**.

It's really that easy!

 If you press a Fav key that hasn't been saved as a Favourite, the display flashes **[tbd]** 3 times and returns to the previous screen.

CARE, CLEANING AND STORAGE

Clean your Instant Pot Pro and its parts after each use. Failure to follow these cleaning instructions may result in property damage and/or personal injury.

Always unplug your multicooker and let it cool to room temperature before cleaning. Never use metal scouring pads, abrasive powders or harsh chemical detergents on any of the Instant Pot's parts or accessories.

Let all surfaces dry thoroughly before use, and before storage.

Parts	Cleaning methods and instruction
Accessories <ul style="list-style-type: none"> • Steam rack 	Dishwasher safe if placed on the top rack.
Lid and parts <ul style="list-style-type: none"> • Steam release valve • Steam release cover • Anti-block shield • Sealing ring • Float valve • Silicone cap • QuickCool cover • Condensation collector 	Dishwasher safe if placed on the top rack. Remove all the parts from the lid before cleaning. See Care, cleaning and storage: Removing and installing parts. <ul style="list-style-type: none"> • With the steam release valve and anti-block shield removed, clean the interior of the steam release pipe with a pipe cleaner to prevent clogging. • To drain water from the lid after dishwashing, grasp the lid handle and hold the lid vertically over a sink, then turn it 360°— like turning a steering wheel. • After cleaning and draining, store the lid upside down on the multicooker base to allow it to air dry completely. • Store sealing rings in a well-ventilated area to decrease residual odour of flavourful meals. To eliminate odours, add 1 cup (250 mL) water and 1 cup (250 mL) white vinegar to the inner pot, then run Pressure Cook for 5 to 10 minutes and QR pressure. • Check the condensation collector after each use and empty and clean it as needed. Do not allow food or moisture to sit in the condensation collector, as harmful bacteria may result.
Inner pot	Dishwasher safe. <ul style="list-style-type: none"> • Acute hard water staining (rainbow, bluish or white discolouration) may require scrubbing with a sponge dampened with vinegar or a non-abrasive cleanser like Bar Keeper's Friend. • For tough or burned food residue, add boiling water and dish soap to the inner pot and let it sit for a few hours for easy cleaning. • Make sure all exterior surfaces are dry before placing the inner pot in the multicooker base.
Power cord	Wipe only. <ul style="list-style-type: none"> • Use a barely damp cloth to remove particles from the cord. • Wrap it around the multicooker base and tuck the end into the cord holder.
Multicooker base	Wipe only. <ul style="list-style-type: none"> • Wipe the inside of the outer pot as well as the condensation rim with a barely damp cloth. Allow them to dry completely before inserting the inner pot. • Clean the multicooker base and control panel with a soft, barely damp cloth or sponge.

Some discolouration may occur after machine washing, but this will not affect the multicooker's safety or performance.

CARE, CLEANING AND STORAGE

⚠ WARNING

The multicooker base contains electrical components. To avoid fire, electric leakage and/or personal injury, make sure the multicooker base always stays dry.

- DO NOT immerse the multicooker base in water or other liquid or attempt to cycle it through the dishwasher.
- DO NOT rinse the heating element.
- DO NOT submerge or rinse the power cord or the plug.

Removing and installing parts

Silicone sealing ring

Remove the sealing ring

Grip the edge of the silicone and pull the sealing ring out from behind the circular stainless-steel sealing ring rack.

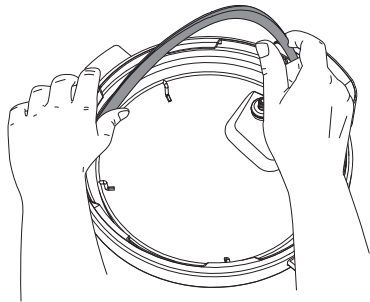

With the sealing ring removed, check the ring rack to make sure it is secured, centered, and at an even height all the way around the lid. Do not attempt to repair a deformed ring rack.

 **Instant Tip:** The sealing ring is easiest to remove when it is wet and soapy.

Install the sealing ring

Place the sealing ring over the sealing ring rack and firmly press it into place. Make sure there's no puckering.

 It should be snug behind the sealing ring rack. It can wiggle a bit but shouldn't fall out when you turn over the lid.

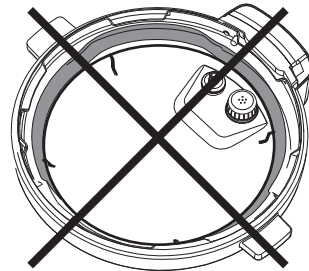
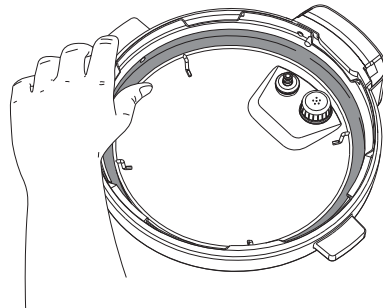

CARE, CLEANING AND STORAGE

Steam release assembly

Remove the steam release assembly

Remove the steam release cover, then pull the steam release valve up and off the steam release pipe.

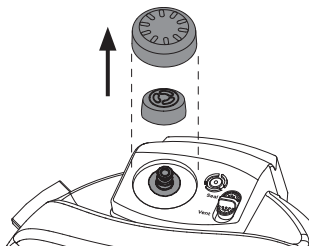

Install the steam release assembly

Place the steam release valve on the steam release pipe and press down firmly.

 The steam release valve sits loosely on the steam release pipe but should remain in place when the lid is turned over.

Place the steam release cover over the steam release valve and press down. The cover pressure-fits in place.

QuickCool protective cover

Remove the protective cover

Grip the tab and push it towards the lid handle, then pull it up, towards you, and off.

Install the protective cover

Grip the tab and slide the cover towards the back of the metal portion of the lid, then press down until it clicks.

Anti-block shield

Remove the anti-block shield

Grip the lid like a steering wheel and use your thumbs to press firmly against the side of the anti-block shield (pressing towards the side of the lid and up) until it pops off the prongs underneath.

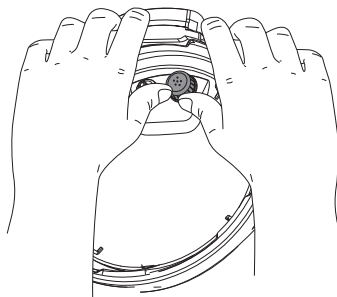

Install the anti-block shield

Place the anti-block shield over the prongs and press down until it snaps into position.

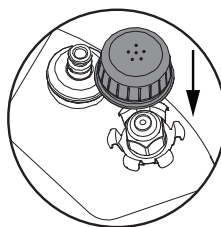

CARE, CLEANING AND STORAGE

Float valve and silicone cap

Remove the float valve from the lid

Place one finger on the flat top of float valve, then turn the lid over. Detach the silicone cap from the bottom side of the float valve, and remove the float valve from the top of the lid.

 Do not discard the float valve or silicone cap!

Top

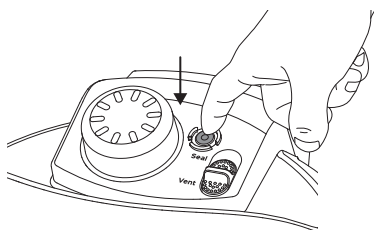

Bottom

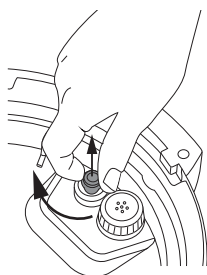

Install the float valve

Drop the narrow end of the float valve into the float valve hole on the top of the lid. Place one finger on the flat top of the float valve, then turn the lid over. Firmly attach the silicone cap to the bottom of the float valve.

Condensation collector

The condensation collector sits at the back of the multicooker base and catches any overflow from the condensation rim.

Remove the condensation collector

Pull the condensation collector away from the multicooker base; do not pull down. Note the tabs on the multicooker base and the grooves on the condensation collector.

Install the condensation collector

Align the grooves on the condensation collector over the tabs on the back of the multicooker base and slide the condensation collector into place like closing a drawer.

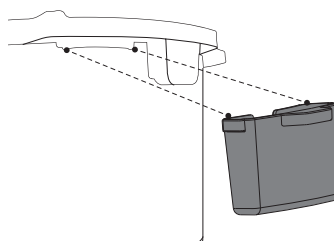

QuickCool protective cover

Remove the protective cover

Grip the tab and push it towards the lid handle, then pull it up, towards you, and off.

Install the protective cover

Grip the tab and slide the cover towards the back of the metal portion of the lid, then press down until it clicks.

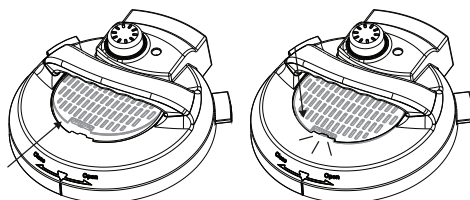

TROUBLESHOOTING

Register your Instant Pot Pro today at instantpot.com.au/support/register.

If your problem persists or if you have any questions, get in touch with Customer Care by email at support@instantpot.com.au or by phone at **1800 251 643** or **(02) 9317 1000**.

Problem	Possible reason	Try this
Occasional clicking or light cracking sound.	The sound of power switching and expanding pressure board when changing temperatures.	This is normal; no action needed.
	Bottom of the inner pot is wet.	Wipe exterior surfaces of the inner pot. Make sure the heating element is dry before inserting the inner pot into the multicooker base.
Difficulty closing the lid.	Sealing ring is not properly installed.	Reposition the sealing ring. Make sure it is snug behind the sealing ring rack.
	Float valve is in the popped-up position.	Gently press the float valve downward with a long utensil.
	Contents in multicooker are still hot.	Hold the quick release switch in the Vent position as you lower the lid onto the multicooker base slowly, allowing heat to dissipate.
Difficulty opening the lid.	⚠ DANGER Contents may be under pressure. To avoid scalding injury, DO NOT attempt to force the lid open.	
	Pressure inside the multicooker.	Release pressure according to recipe. Only open the lid after the float valve has dropped down.
	Float valve stuck in the popped-up position due to food debris or residue.	Release pressure completely, then tap the float valve gently with a long utensil. You may need to allow the multicooker to cool slightly so all pressure can be released.
		Open the lid cautiously, then thoroughly clean the float valve, surrounding area, and lid before next use.
The inner pot is stuck to the lid when the multicooker is opened.	Cooling of the inner pot may create suction, causing the inner pot to adhere to the lid.	To release the vacuum, move the quick release switch to the Vent position.

TROUBLESHOOTING

Problem	Possible reason	Try this
Steam leaks from side of lid.	No sealing ring in the lid.	Install a sealing ring.
	The sealing ring is damaged or not installed properly.	Replace the sealing ring.
	Food debris on the sealing ring.	Remove the sealing ring and clean it thoroughly.
	The lid is not closed properly.	Open, then close the lid.
	The sealing ring rack is warped or off-centre.	Remove the sealing ring from the lid, then check the sealing ring rack for bends or warps. Contact Customer Care .
	The inner pot rim may be misshapen.	Check for deformation and contact Customer Care .
The float valve does not rise.	Food debris on the float valve or float valve silicone cap.	Remove the float valve from the lid and clean it thoroughly. Perform the Initial test run to check for function and record your findings. Contact Customer Care .
	Too little liquid in the inner pot.	Check for scorching on the bottom of the inner pot. Add thin, water-based liquid to the inner pot according to its size. 5.7L: 1 ½ cups (375 mL) 8L: 2 cups (500 mL)
	Float valve silicone cap damaged or missing.	Install or replace the float valve and/or silicone cap.
	Float valve obstructed by lid-locking mechanism.	Tap the float valve with a long utensil. If the float valve does not drop, turn the multicooker off. Contact Customer Care .
	No heat in the inner pot.	Perform the Initial test run to check for function and record your findings. Contact Customer Care .
	Inner pot base may be damaged.	Perform the Initial test run to check for function and record your findings. Contact Customer Care .
Minor steam leaking or hissing from the steam release valve during the cook cycle.	Quick release switch is not in the Seal position.	Move the quick release switch to the Seal position. Add additional liquid to the inner pot.
	Multicooker is regulating excess pressure.	This is normal; no action required.
	Too little liquid in the inner pot.	Ensure there is minimum liquid in the inner pot.
The display remains blank after connecting the power cord.	Bad power connection or no power.	Check outlet to make sure it is powered. Inspect power cord for damage. If damage is noticed, contact Customer Care .
	Multicooker's electrical fuse has blown.	Contact Customer Care .

TROUBLESHOOTING

Problem	Possible reason		Try this
Steam gushes from the steam release valve when the quick release switch is in the Seal position.	Not enough liquid in the inner pot.		Add thin, water-based liquid to the inner pot according to its size. 5.7L: 1 ½ cups (375 mL) 8L: 2 cups (500 mL)
	Pressure sensor control failure.		Contact Customer Care .
	Steam release valve is not seated properly.		Move the steam release switch to Vent then back to the Seal position.
Error code appears on the display and the multicooker beeps continuously.	C1 C3 C4 C6	Faulty sensor.	Contact Customer Care .
	C7	Heat element has failed.	Contact Customer Care .
		Not enough liquid. Multicooker lid is not used for pressure cooking functions.	Add thin, water-based liquid to the inner pot according to its size. 5.7L: 1 ½ cups (375 mL) 8L: 2 cups (500 mL) Put on the lid and restart.
	C8	Incorrect inner pot is used.	Only use a stainless-steel Pro Series inner pot with Easy Grip handles with the Pro.
	Lid	The lid is not in the correct position for the selected programme.	Open and close the lid. Do not use a lid when using Sauté.
	Food burn	High temperature detected at bottom of inner pot; the multicooker automatically reduces the temperature to avoid overheating.	Starch deposits at the bottom of the inner pot may have blocked heat dissipation. Turn the multicooker off, release pressure and inspect the bottom of the inner pot.
	PrSE	Pressure has accumulated during a non-pressure cooking programme.	Touch Cancel and Quick Release pressure.

Any other servicing must be performed by an authorised representative.

WARRANTY

Limited Warranty

This Limited Warranty is issued by Corelle Brands (Australia) Pty Ltd (Corelle Brands Australia) and is effective for one year from the date of original consumer purchase. Proof of original purchase date and return of your appliance is required to obtain service under this Limited. Return of your appliance to us will be done in accordance with our instructions only. Provided that this appliance is operated and maintained in accordance with written operating instructions attached to or furnished with the appliance or published operating instructions on www.instantpot.com.au, Corelle Brands Australia will, in its sole and exclusive discretion, either: (i) repair defects in materials or workmanship; or (ii) replace the appliance. In the event that your appliance is replaced, the Limited Warranty on the replacement appliance will expire 12 months from the date of original consumer purchase.

We remind you the appliance you purchased is for personal use only (not commercial use).

Any modification/alteration or attempted modification/alteration to your appliance will void this Limited Warranty, unless such modification/alteration or attempted modification/alteration was expressly authorised by a Corelle Brands Australia Representative in writing.

This Limited Warranty only covers Corelle Brands Australia's appliances/products and is not extended to any other appliances, products, equipment, components, or devices that you use or may use in conjunction with the Corelle Brands Australia's appliances.

To claim under this Limited Warranty:

1. Contact Corelle Brands Australia at:
Sydney Corporate Park
Level 1, 184 Bourke Road, Alexandria, NSW 2015
Email: sales.australia@instantbrands.com
2. Provide a description of the appliance you believe has malfunctioned due to defective parts or workmanship.
3. If it is necessary for the appliance to be sent to Corelle Brands Australia for repair or replacement, Corelle Brands Australia will send you a pre-paid shipping label and you must send the appliance and your dated sales receipt to Corelle Brands Australia along with the appliance. If you do not have your dated sales receipt, please advise Corelle Brands Australia in advance, and Corelle Brands Australia will attempt to verify your purchase.
4. If Corelle Brands Australia determines that the appliance has malfunctioned due to defective parts or workmanship, and is covered under this Limited Warranty, Corelle Brands Australia will repair and return the appliance, or send you a replacement appliance, at Corelle Brands Australia's cost.
5. Any repaired or replaced appliance will be covered by this Limited Warranty for the remainder of the original warranty period or ninety (90) days following your receipt of the replacement or repaired appliance, whichever is greater.

WARRANTY

6. If Corelle Brands Australia confirms the appliance has not malfunctioned due to defective parts or workmanship, and/or is in working order, or if proof of purchase is not verified, Corelle Brands Australia reserves the right to return the appliance to you at your pre-paid cost. If this cost is not met, Corelle Brands Australia reserves the right to dispose of the appliance after 45 days' notice to you.

Limitation and Exclusions

To the maximum extent permitted by law, the maximum liability of Corelle Brands Australia, if any, for any allegedly defective appliance or part shall in no circumstances exceed the purchase price of a comparable replacement appliance or part of the same age.

This Limited Warranty does not cover:

Damage resulting from accident, modification/alteration (unless expressly authorised by a Corelle Brands Australia Representative in writing), misuse, abuse, neglect, unreasonable use, use contrary to the written operating instructions attached to or furnished with the appliance or published operating instructions on www.instantpot.com.au, normal wear and tear, commercial use, improper assembly by you or anyone, disassembly by you or anyone, repair by you or anyone, failure to provide reasonable and necessary maintenance, force majeure event including but not limited to fire, flood, acts of God;

Repairs where your appliance is used for other than normal, personal use or when it is used in a manner that is contrary to the written operating instructions attached to or furnished with the appliance or published operating instructions on www.instantpot.com.au ; or

Use of unauthorised parts and accessories, or repairs to parts and systems resulting from unauthorised repairs or modifications/alterations made to your appliance.

The cost of repair or replacement under these excluded circumstances shall be borne by you. Our goods come with guarantees that cannot be excluded under the Australian Consumer Law. You are entitled to a replacement or refund for a major failure and compensation for any other reasonably foreseeable loss or damage. You are also entitled to have the goods repaired or replaced if the goods fail to be of acceptable quality and the failure does not amount to a major failure.

Distributed by Corelle Brands (Australia) Pty Ltd.
Sydney Corporate Park
Level 1, 184 Bourke Road, Alexandria, NSW 2015.
1800 251 643 or (02) 9317 1000.
Email: sales.australia@instantbrands.com

© 2022 Corelle Brands (Australia) Pty Ltd.
Distributed by Corelle Brands (Australia) Pty Ltd.
An Instant Brands Company.
Sydney Corporate Park
Level 1, 184 Bourke Road, Alexandria, NSW, 2015, Australia

instantpot.com.au

© 2022 Instant Brands LLC.
814-0124-91