

get started

INSTANT POT® DUO™
MULTI-COOKER

Instant

Table of contents

IMPORTANT SAFEGUARDS	4
Special cord set instructions.....	9
Product specifications.....	9
Find your model name and serial number.....	9
Product, parts and accessories	10
Get started	12
Initial set up.....	12
Initial test run (water test).....	13
Pressure cooking 101	14
Releasing pressure	15
Venting methods.....	15
Control panel	17
Settings	18
Status messages	20
Pressure control features	21
Multicooker lid.....	22
Steam release handle.....	22
Sealing ring.....	23
Float valve.....	23
Anti-block shield.....	24
Pressure cooking	24
Jump start magic!.....	25
Smart programme breakdown.....	26
Pressure cooking tips.....	28
Pressure cooking grains.....	30

Table of contents

Other cooking styles.....	31
Slow Cook	32
Sauté.....	33
Deglazing the inner pot (pressure cooking after sauté)	34
Yogurt.....	35
Using yogurt cups.....	36
Care, cleaning and storage.....	37
Removing and installing parts	38
Troubleshooting.....	41
Warranty	44
Contact.....	46

IMPORTANT SAFEGUARDS



At Instant Brands™ your safety always comes first. The Instant Pot® Duo™ was designed with your safety in mind. As always, be careful when using electrical appliances and follow basic safety precautions.

- 01** READ ALL INSTRUCTIONS, SAFEGUARDS AND WARNINGS BEFORE USE. FAILURE TO FOLLOW THESE SAFEGUARDS AND INSTRUCTIONS MAY RESULT IN INJURY AND/OR PROPERTY DAMAGE.
- 02** Use only the Instant Pot Duo lid with the Instant Pot Duo multicooker base. Using any other multicooker lids may cause injury and/or damage.
- 03** For household use only. Not for commercial use. DO NOT use the appliance for anything other than its intended use.
- 04** For countertop use only. Always operate the appliance on a stable, non-combustible, level surface.
 - DO NOT place on anything that may block the vents on the bottom of the appliance.
 - DO NOT place on a hot stove.
- 05** Heat from an external source will damage the appliance.
 - DO NOT place the appliance on or close to a hot gas or electric burner, or a heated oven.
 - DO NOT use the appliance near water or flame.
 - DO NOT use outdoors. Keep out of direct sunlight.
- 06** DO NOT touch the appliance's hot surfaces. Only use the side handles for carrying or moving.
 - DO NOT move the appliance when it is under pressure.
 - DO NOT touch accessories during or immediately after cooking.
 - DO NOT touch the metal portion of the lid when the appliance is in operation; this could result in injury.
 - Always use hand protection when removing accessories, and to handle the inner pot.
 - Always place hot accessories on a heat-resistant surface or cooking plate.

WARNING

Read this manual carefully and completely and retain for future reference. Failure to adhere to safety instructions may result in serious injury or damage.

IMPORTANT SAFEGUARDS



- 07 The removable inner pot can be extremely heavy when full of ingredients. Care should be taken when lifting the inner pot from the multicooker base to avoid burn injury.
- Extreme caution must be used when the inner pot contains hot food, hot oil or other hot liquids.
 - DO NOT move the appliance while it is in use and use extreme caution when disposing of hot grease.
- 08 **⚠ CAUTION** Overfilling may cause a risk of clogging the steam release pipe and developing excess pressure, which may result in burns, injury, and/or property damage.
- DO NOT fill over **PC MAX — 2/3** as indicated on the inner pot.
 - DO NOT fill the inner pot over — **1/2** line when cooking foods that expand during cooking such as rice or dried vegetables.
- 09 **⚠ WARNING** This appliance cooks under pressure. Any pressure in the appliance can be hazardous. Allow the appliance to depressurise naturally or release all excess pressure before opening. Inappropriate use may result in burns, injury and/or property damage.
- Make sure the appliance is properly closed before operating. Refer to **Pressure control features: multicooker lid**.
 - DO NOT cover or obstruct the steam release handle and/or float valve with cloth or other objects.
 - DO NOT attempt to open the appliance until it has depressurised, and all internal pressure has been released. Attempting to open the appliance while it is still pressurised may lead to sudden release of hot contents and may cause burns or other injuries.
 - DO NOT place your face, hands or exposed skin over the steam release handle or float valve when the appliance is in operation or has residual pressure, and do not lean over the appliance when removing the lid.
 - Turn the appliance off if steam escapes from the steam release handle and/or float valve in a steady stream for longer than 3 minutes.
 - If steam escapes from the sides of the lid, turn the appliance off and make sure the sealing ring is properly installed. Refer to **Pressure**

⚠ WARNING

Read this manual carefully and completely and retain for future reference.
Failure to adhere to safety instructions may result in serious injury or damage.

IMPORTANT SAFEGUARDS



control features: sealing ring.

- DO NOT attempt to force the lid off the Instant Pot multicooker base. Refer to **Releasing pressure**.
- 10 When cooking meat with skin (e.g. sausage with casing), the skin can swell when heated. Do not pierce the skin while it is swollen; this could result in scalding injury.
 - 11 When pressure cooking food with a doughy or thick texture, or a high fat/oil content, contents may splatter when opening the lid. Follow recipe instructions for pressure release method. Refer to **Releasing pressure**.
 - 12 Oversized foods and/or metal utensils must not be inserted into the inner pot as they may cause risk of fire and/or personal injury.
 - 13 Proper maintenance is recommended before and after each use:
 - Check the steam release handle, steam release pipe, anti-block shield and float valve for clogging.
 - Before inserting the inner pot into the multicooker base, make sure both parts are dry and free of food debris.
 - Let the appliance cool to room temperature before cleaning or storage.
 - 14 DO NOT use this appliance for deep frying or pressure frying with oil.
 - 15 If the power cord is detachable, always attach the plug to the appliance first, then plug the cord into the wall outlet. To turn off, press Cancel, then remove the plug from power source. Always unplug when not in use, as well as before adding or removing parts or accessories, and before cleaning. To unplug, grasp the plug and pull from the outlet. Never pull from the power cord.
 - 16 Regularly inspect the appliance and power cord. Do not operate the appliance if the power cord or plug is damaged, or after the appliance malfunctions or is dropped or damaged in any manner. For assistance, contact Customer Care by email at support@instantpot.com.au or by phone at **1800 251 643** or **(02) 9317 1000**.
 - 17 Spilled food can cause serious burns. A short power-supply cord is provided to reduce the hazards resulting from grabbing, entanglement and tripping.

WARNING

Read this manual carefully and completely and retain for future reference.
Failure to adhere to safety instructions may result in serious injury or damage.

IMPORTANT SAFEGUARDS



- DO NOT let the power cord hang over edges of tables or counters, or touch hot surfaces or open flame, including the stovetop.
 - DO NOT use below-counter power outlets, and never use with an extension cord.
 - Keep the appliance and cord away from children.
- 18** DO NOT use any accessories or attachments not authorised by Instant Brands LLC. The use of parts, accessories or attachments not recommended by the manufacturer may cause a risk of injury, fire or electric shock.
- To reduce the risk of pressure leakage, cook only in an authorised stainless-steel Instant Pot inner pot.
 - DO NOT use the appliance without the removable inner pot installed.
 - To prevent personal injury and damage to the appliance, only replace the sealing ring with an authorised Instant Pot sealing ring.
- 19** DO NOT attempt to repair, replace or modify components of the appliance, as this may cause electric shock, fire or injury, and will void the warranty.
- 20** DO NOT tamper with any of the safety mechanisms, as this may result in injury or property damage.
- 21** The multicooker base contains electrical components. To avoid electrical shock:
- DO NOT put liquid of any kind into multicooker base.
 - DO NOT immerse power cord, plug or the appliance in water or other liquid.
 - DO NOT rinse the appliance under tap.
- 22** DO NOT use the appliance in electrical systems other than 220-240V~50/60Hz. Do not use with power converters or adapters.
- 23** This appliance is NOT to be used by children or by persons with reduced physical, sensory or mental capabilities. Close supervision is necessary when any appliance is used near children and these individuals. Children should not play with this appliance.

WARNING

Read this manual carefully and completely and retain for future reference.
Failure to adhere to safety instructions may result in serious injury or damage.

IMPORTANT SAFEGUARDS



- 24 DO NOT leave the appliance unattended while in use. Never connect this appliance to an external timer switch or separate remote-control system.
- 25 DO NOT store any materials in the multicooker base or inner pot when not in use.
- 26 DO NOT place any combustible materials in the multicooker base or inner pot, such as paper, cardboard, plastic, Styrofoam or wood.
- 27 DO NOT use the included accessories in a microwave, toaster oven, convection or conventional oven, or on a ceramic cooktop, electric coil, gas range or outdoor grill.

SAVE THESE INSTRUCTIONS.

⚠ WARNING

To avoid injury, read and understand the instructions in this user manual before attempting to use this appliance.

⚠ WARNING

Electrical shock hazard. Use grounded outlet only.

- DO NOT remove ground.
- DO NOT use an adapter.
- DO NOT use an extension cord.

Failure to follow these instructions may result in electric shock and/or serious injury.

⚠ WARNING

THE FAILURE TO FOLLOW ANY OF THE IMPORTANT SAFEGUARDS AND/OR THE INSTRUCTIONS FOR SAFE USE IS A MISUSE OF YOUR APPLIANCE THAT CAN VOID YOUR WARRANTY AND CREATE THE RISK OF SERIOUS INJURY.

⚠ WARNING

Read this manual carefully and completely and retain for future reference. Failure to adhere to safety instructions may result in serious injury or damage.

IMPORTANT SAFEGUARDS









Special cord set instructions

Per safety requirement, a short power supply cord is provided to reduce the hazards resulting from entanglement and tripping.

This appliance has a 3-prong grounding plug. To reduce the risk of electric shock, plug the power cord into a grounded electrical outlet that is easily accessible.

Product specifications

					
Duo Mini	700W	220-240V~ 50/60Hz	3 Litres	3.9 kg	cm: 29L x 25.5W x 28.5H
Duo 60	1000W	220-240V~ 50/60Hz	5.7 Litres	5.44 kg	cm: 33.5L x 31W x 31.7H
Duo 80	1200W	220-240V~ 50/60Hz	8 Litres	7.16 kg	cm: 37.6L x 33.8W x 36.1H

Find your model name and serial number

Model name: Find it on the label on the back of the multicooker base, near the power cord.

Serial number: Turn the multicooker base over – you'll find this info on a sticker on the bottom.

WARNING

Read this manual carefully and completely and retain for future reference.
Failure to adhere to safety instructions may result in serious injury or damage.

Product, parts and accessories

See **Care, cleaning and storage: Removing and installing parts** to find out how everything fits together.

Top of lid

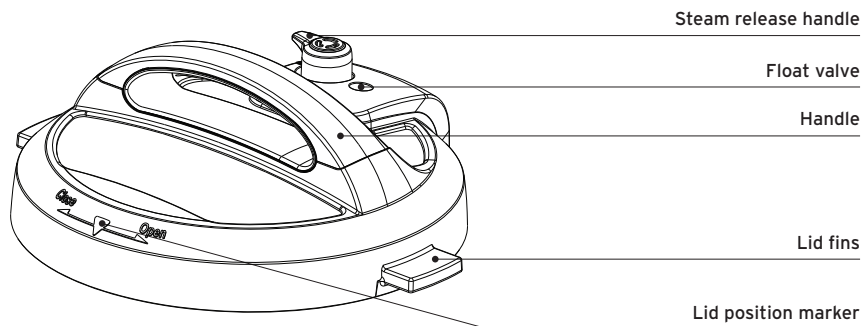

Bottom of lid

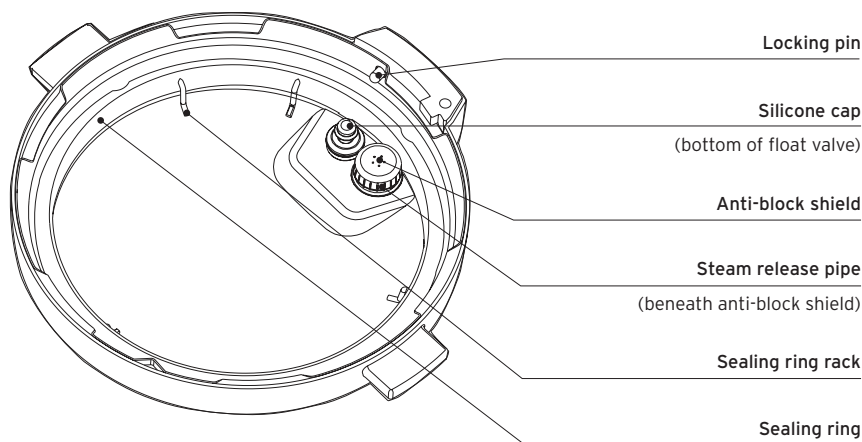

 Stand the lid up in the multicooker base to keep it off your countertop! Insert the left or right lid fin into corresponding slot in the multicooker base handles to stand it up and save some space.

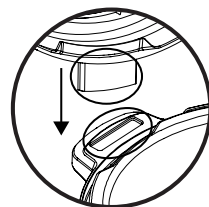

Illustrations in this document are for reference only and may differ from the actual product. Always refer to the actual product.

Product, parts and accessories

Inner pot

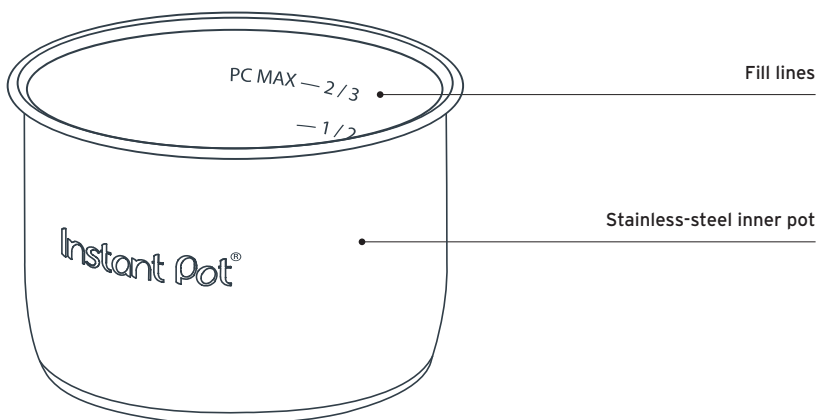

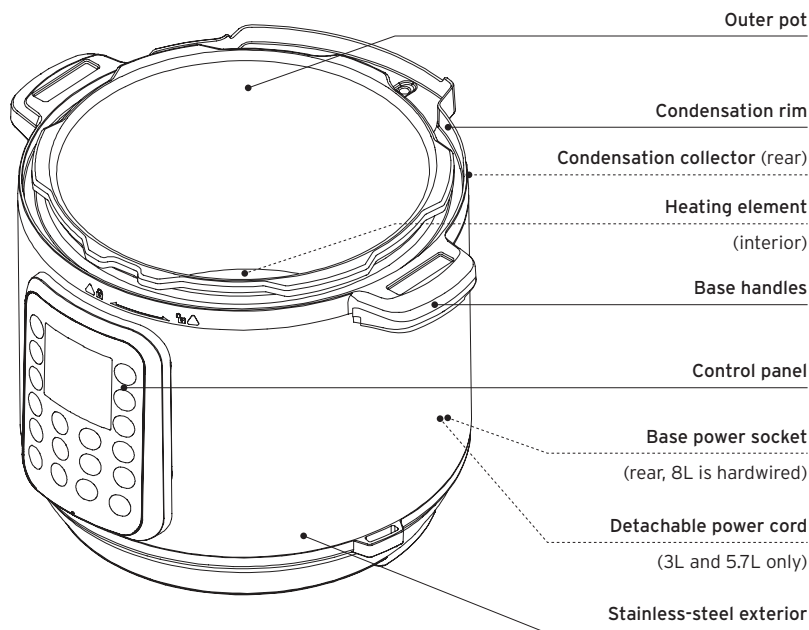

Multicooker base



Illustrations in this document are for reference only and may differ from the actual product. Always refer to the actual product.

Get started

Initial set up

- 01 Pull that Duo out of the box!
- 02 Remove the packaging material and accessories from in and around the multicooker.
 Make sure to check under the inner pot!
- 03 Wash the inner pot in a dishwasher or with hot water and dish soap. Rinse it well with warm, clear water and use a soft cloth to thoroughly dry the outside of the inner pot.
- 04 Wipe the heating element with a soft, dry cloth to make sure there are no stray packaging particles left in the multicooker base.
 Don't remove the safety warning stickers from the lid or the rating label from the back of the multicooker base.
- 05 You may be tempted to put the Duo on your stovetop – *but don't do it!*
Place the multicooker base on a stable, level surface, *away* from combustible material and external heat sources.

Is something missing or damaged?

Get in touch with Customer Care by email at support@instantpot.com.au or by phone at **1800 251 643** or **(02) 9317 1000**.

Feeling keen?

- Check out **Product, parts and accessories** to get to know your Instant Pot's components, then read over **Pressure control features** for an in-depth look.
- While you're doing the **Initial test run (water test)**, read over **Pressure cooking 101** to find out how the magic happens!

⚠ WARNING		
Read the Important safeguards before using the appliance. Failure to read and follow those instructions for safe use may result in damage to the appliance, property damage or personal injury.	Do not place the appliance on a stovetop or upon another appliance. Heat from an external source will damage the appliance.	Do not place anything on top of the appliance, and do not cover or block the steam release handle or anti-block shield, located on the appliance lid.

Get started

Initial test run (water test)

Do you *have* to do the water test? No – but getting to know the ins and outs of your Duo prepares you for success in the kitchen! Take a few minutes to get to know how this baby works.

Stage 1: Setting up the Duo for pressure cooking

01 Remove the inner pot from the multicooker base. Add 750 mL of water to the inner pot, then insert it back into the multicooker base.

02 3L & 5.7L models: Secure the power cord to the base power socket on the back of the multicooker base. Make sure the connection is tight.

All models: Connect the power cord to a 220-240V power source.

The display shows **OFF**.

03 Place and close the lid as described in **Pressure control features: Multicooker lid**.

04 Turn the steam release handle to the **Sealing** position.

Stage 2: "Cooking" (...hot water à la king, anyone?)

01 Select **Pressure Cook**.

02 Use the **- / +** buttons to adjust the cooking time to 5 minutes (**00:05**).

 Adjustments are saved when a Smart Programme starts, so the next time you use Pressure Cook, it will default to 5 minutes.

03 Press **Keep Warm** to turn the automatic Keep Warm setting off.

04 The multicooker beeps after 10 seconds and the display shows **On**.

 While the multicooker does its thing, read **Pressure cooking 101** on the next page to find out how the magic happens.

05 When the Smart Programme finishes, the display shows **End**.

Stage 3: Releasing pressure

01 Follow instructions for a Quick Release in **Releasing pressure: Venting methods**.

02 Wait for the float valve to drop, then carefully open and remove the lid as described in **Pressure control features: Multicooker lid**.

03 Using proper hand protection, remove the inner pot from the multicooker base, discard the water and thoroughly dry the inner pot.

That's it! You're good to go :)

CAUTION

Pressurised steam releases through the top of the steam release handle. Keep exposed skin away from the steam release handle.

DANGER

DO NOT attempt to remove the lid while the float valve is up and NEVER attempt to force the lid open. Contents are under extreme pressure. Float valve must be down before attempting to remove the lid. Failure to follow these instructions may result in serious personal injury and/or property damage.

CAUTION

The inner pot will be hot after cooking. Always use appropriate heat protection when handling a hot inner pot.

Pressure cooking 101

Pressure cooking uses steam to raise the boiling point of water above 100°C. These high temperatures allow you to cook food way faster than normal.

When pressure cooking, the Instant Pot goes through 3 stages.

Pre-heating

What you see	What you don't see	Tips
The display shows On .	<p>While the multicooker preheats, it vaporises liquid to create steam.</p> <p>Once enough steam has built up, the float valve pops up and locks the lid in place.</p>	<p>The time it takes the multicooker to pressurise depends on things like food and liquid temperature and volume.</p> <p>Frozen foods have the longest pre-heating time. For the fastest results, thaw your food before cooking it.</p> <p>No need to hang around during this stage – trust that IP magic!</p>

Cooking

What you see	What you don't see	Tips
The float valve bobs up and down from all the steam, then pops up and stays flush with the lid. The display switches to the cooking countdown timer.	<p>When it reaches the required pressure level, cooking begins.</p> <p>The Instant Pot automatically maintains the cooking pressure at High or Low pressure.</p>	<p>A higher pressure means a higher temperature.</p> <p>Smart Programme settings (e.g., cooking time, pressure level, etc.) can be adjusted at any time during cooking.</p>

Releasing pressure

What you see	What you don't see	Tips
<p>If Keep Warm is on after cooking, the timer counts up from 00:00.</p> <p>If not, the multicooker goes back to standby and the display shows End.</p> <p>The float valve is still popped up.</p>	<p>Although food has finished cooking, the multicooker is still pressurised and hot, which is why the float valve is up.</p> <p>Releasing pressure lowers the temperature inside the multicooker, which allows you to safely remove the lid once the float valve drops.</p>	<p>See Releasing pressure for information on safe venting techniques and what they're used for.</p> <p>Follow your recipe instructions to choose the best venting method for your meal.</p> <hr/> <p> The Instant Pot cools faster if Keep Warm is turned off.</p>

Releasing pressure

You **must** release pressure after pressure cooking before attempting to open the lid. Follow your recipe's instructions to choose a venting method, and always wait until the float valve drops into the lid before opening.

Venting methods

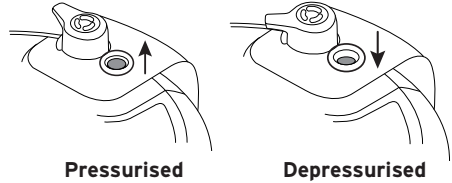

- Natural Release (NR or NPR)
- Quick Release (QR or QPR)
- Timed Natural Release



⚠ WARNING	
Steam ejected from the steam release handle is hot. DO NOT place hands, face, or any exposed skin over the steam release handle when releasing pressure.	DO NOT cover the steam release handle.
⚠ DANGER	
DO NOT attempt to remove the lid while the float valve is up and NEVER attempt to force the lid open. Contents are under extreme pressure. Float valve must be down before attempting to remove the lid. Failure to follow these instructions may result in serious personal injury and/or property damage.	

Natural Release (NR or NPR)

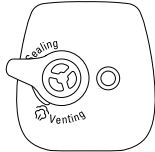
Cooking stops gradually. As the temperature within the multicooker drops, the Instant Pot depressurises naturally over time.

What to do	What to expect
After cooking finishes, leave the steam release handle in the Sealing position until all pressure is released. <div style="text-align: center; margin-top: 10px;">  <p>Sealing position</p> </div>	Your meal continues to cook even after the Smart Programme ends. <div style="margin-top: 10px;">  <p>This is called “carryover cooking” or “resting”, and it’s great for large cuts of meat.</p> <p>The depressurisation time may vary based upon the volume, type and temperature of food and liquid. It can take up to 40 minutes with some dishes, so plan ahead – it’s well worth the wait!</p> <p>When pressure has been fully released, the float valve drops into the lid.</p> </div>

NOTICE
Use NR to depressurise the multicooker after cooking high-starch foods (e.g., soups, stews, chilis, pasta, oatmeal and congee) or after cooking foods that expand when cooked (e.g., beans and grains).

Releasing pressure

Quick Release (QR or QPR)

Stops cooking quickly and prevents overcooking. Perfect for quick-cooking vegetables and delicate seafood!

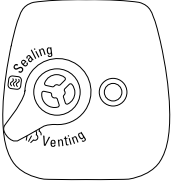
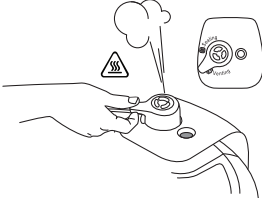
What to do	What to expect
<p>Carefully, quickly and confidently, turn the steam release handle to Venting and wait for all pressure inside the multicooker to release.</p>  <p>Venting position</p>	<p>A jet of steam ejects through the top of the steam release handle.</p> <p>This is normal!</p> <p>When pressure has been fully released, the float valve drops into the lid.</p> 

Timed natural release

The carryover cooking continues for a specific amount of time, then stops quickly when you release the remaining pressure. Perfect for finishing rice and grains.

What to do	What to expect
<p>Leave the steam release handle in the Sealing position for a while (according to your recipe) then turn it to Venting and wait for all pressure inside the multicooker to release.</p>	<p>A jet of steam ejects through the top of the steam release handle.</p> <p> The temperature within the multicooker drops, so the steam release may not be as powerful as a normal QR.</p> <p>When pressure has been fully released, the float valve drops into the lid.</p>

If there is substantial spatter while venting, turn the steam release handle back to **Sealing**. Wait a few minutes before trying to release pressure again. If spatter continues, use NR to safely release the remaining pressure.

Illustrations in this document are for reference only and may differ from the actual product. Always refer to the actual product.

CAUTION

Steam ejected from the steam release handle is hot. **DO NOT** place hands, face, or any exposed skin over the steam release handle when releasing pressure.

NOTICE

Do not use QR when cooking fatty, oily, thick or high-starch foods (e.g., stews, chilis, pasta and congee) or when cooking foods that expand when cooked (e.g., beans and grains).

Control panel

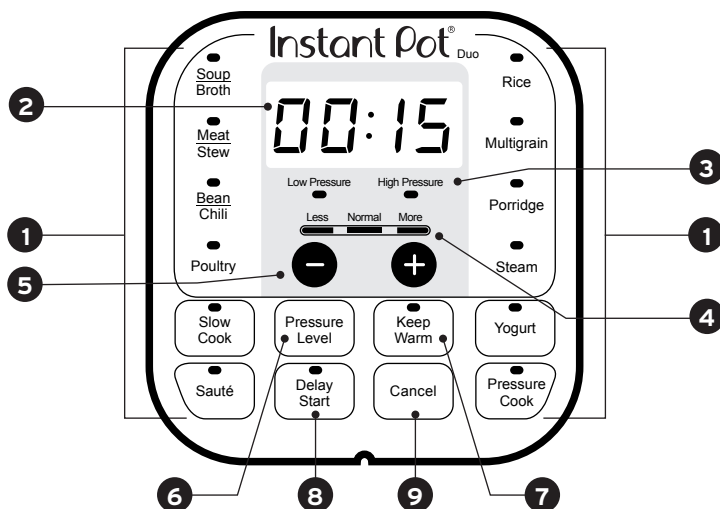



		Pressure cooking	Non-pressure cooking
1	Smart Programmes	<ul style="list-style-type: none"> • Soup/Broth • Meat/Stew • Bean/Chili • Poultry • Rice • Multigrain • Porridge • Steam • Pressure Cook 	<ul style="list-style-type: none"> • Slow Cook • Sauté • Yogurt • Keep Warm
2	Time display	Shows the time in HH:MM format. Counts up or down, depending on the Smart Programme.	
3	Pressure fields	LEDs show if the multicooker is using Low or High pressure during pressure cooking.	
4	Less / Normal / More	Preset cooking time or temperature levels, depending on the Smart Programme.	
5	- / + buttons	Adjust time for cooking, Delay Start and Keep Warm.	
6	Pressure level	Toggle between Low Pressure and High Pressure.	
7	Keep Warm	Turns the Keep Warm setting on or off.	
8	Delay Start	Delay the start of cooking.	
9	Cancel	Stop a Smart Programme at any time.	

Settings

Setting	Description
Turn sound on	When in standby, press and hold the + button until the display shows S On .
Turn sound off.	When in standby, press and hold the - button until the display shows SOFF .  Audible safety and error message alerts cannot be turned off.
Adjust and save custom cooking times and temperatures.	Once a Smart Programme is selected, changes to the cooking time, temperature and pressure level are saved once the Smart Programme begins. See Cooking for details.
Reheat or warm for long periods.	Keep Warm can be used for up to a maximum of 10 hours (10:00) . 01 When in standby, press Keep Warm . 02 Press Keep Warm again to cycle through Less, Normal and More warming temperature levels. 03 Use the - / + buttons to set a warming timer. 04 Keep Warm begins automatically after 10 seconds. When cooking thick or starchy foods, heat may not dissipate evenly. To ensure food safety, stir the contents of thicker dishes every 40 to 60 minutes. When Keep Warm completes, the display shows End .

Settings

Setting	Description
<p>Set a Delay Start timer.</p>	<p>Delay Start can be set from between 10 minutes (00:10) and 24 hours (24:00).</p> <p>01 Select a Smart Programme and tweak it as needed, then press Delay Start.</p> <p> Once pressed, there is no way to go back to the Smart Programme settings. You'll have to press Cancel and start again.</p> <p>02 When the hours field flashes, use the - / + buttons to adjust the hours.</p> <p>03 Press Delay Start again to toggle to the minutes field and use the - / + buttons to adjust the minutes.</p> <p>04 The Delay Start timer starts automatically after 10 seconds.</p> <p>When Delay Start ends, the Smart Programme begins and the display shows On.</p> <p> Delay Start is not available with the Sauté or Yogurt Smart Programmes.</p>
<p>Reset an individual smart programme.</p>	<p>When in standby, press and hold one Smart Programme button until the multicooker returns to Standby and displays OFF.</p> <p>The Smart Programme's pressure level, cooking time and temperature are restored to the factory default setting.</p>
<p>Reset all smart programmes.</p>	<p>When in standby, press and hold Cancel until the multicooker beeps.</p> <p>All Smart Programme pressure levels, cooking times and temperatures are restored to the factory default setting.</p>

Status messages

OFF	The Instant Pot is in standby mode, ready for action!
Lid	May indicate that the lid is missing or is not properly secured.
On	The multicooker is pre-heating.
Auto	The Rice Smart Programme is running.
boil	The Yogurt Smart Programme is in the process of pasteurising milk (i.e., the Yogurt Smart Programme is set to More).
Hot	The inner pot has reached the perfect temperature and is ready to start cooking your food.  Only applies to Sauté.
00:00	Display shows one of the following: <ul style="list-style-type: none"> • When Delay Start is running, the multicooker counts down until the Smart Programme begins; • When a Smart Programme is running, the multicooker counts down the remaining cooking time; • When Keep Warm is running, the multicooker counts the length of time that food has been warming.
End	The Smart Programme has finished and Keep Warm is off.
Food burn	The multicooker is overheating due to insufficient liquid. See Troubleshooting for more information.

Do you see something else? See **Troubleshooting** for more information.

Pressure control features

See **Care, cleaning and storage** for installation and removal of parts.

Multicooker lid

What we love about it	What you should know about it
<p>The lid was designed with lid fins that fit perfectly inside the handles on the left and right sides of the multicooker base to help keep your countertop dry!</p> <p>When the Instant Pot is plugged in it plays a little jingle when you open and close the lid.</p>	<p>The lid is removable during non-pressure cooking so you can taste-test as you go.</p> <p>When you're pressure cooking, the lid only locks into place once the multicooker has pressurised. Try not to remove the lid unnecessarily!</p>

Removing the lid

- 01** Grip the lid handle and turn it counter-clockwise to align the symbol on the lid ▼ with the symbol on the rim of the multicooker base ↗▲.
- 02** Lift the lid up and off the multicooker base towards your body.

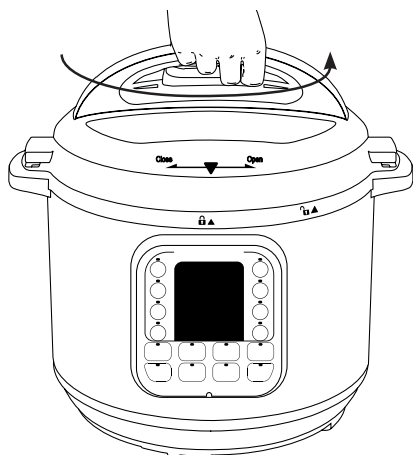

Closing the lid

- 01** Align the symbol on the lid ▼ with the symbol on the multicooker base ↗▲, then lower the lid onto the track.
- 02** Turn the lid clockwise until the symbol on the lid ▼ aligns with the symbol on the multicooker base ⚡▲.

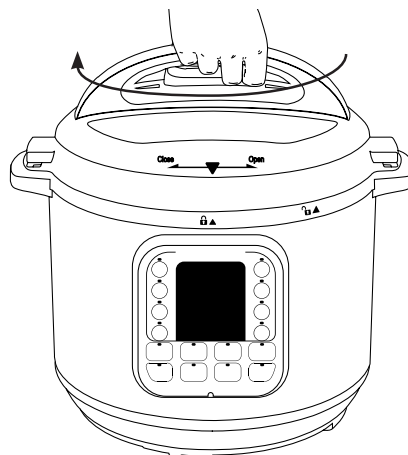

Illustrations in this document are for reference only and may differ from the actual product. Always refer to the actual product.

⚠ WARNING

Only use a compatible Instant Pot Duo lid with the Instant Pot Duo multicooker base. Using any other multicooker lids may cause injury and/or damage.



⚠ CAUTION

Always check the lid for damage and excessive wear prior to cooking.

Pressure control features

Steam release handle

The steam release handle controls the steam, venting it from the top of the steam release handle, or sealing it inside the Instant Pot.

What we love about it	What you should know about it
<p>It's easy to tell when the handle is in the Sealing or Venting position.</p> <div data-bbox="219 457 354 589"></div> <p data-bbox="225 594 360 616">Sealing position</p> <div data-bbox="459 457 595 589"></div> <p data-bbox="459 594 595 616">Venting position</p>	<p>The steam release handle sits loosely on the steam release pipe to pivot easily while under pressure, so it may feel a bit wobbly.</p> <p>This is normal!</p>

The steam release handle is integral to product safety and necessary for pressure cooking. It should be installed before use and cleaned regularly.

See **Releasing pressure** for safe venting methods and information on pressurisation and depressurisation.

⚠ WARNING

Do not cover or block the steam release handle in any way.

Sealing ring

When the multicooker lid is closed, the sealing ring creates an airtight seal between the lid and the inner pot.

The sealing ring must be installed before using the multicooker. Only one sealing ring should be installed in the lid at a time.

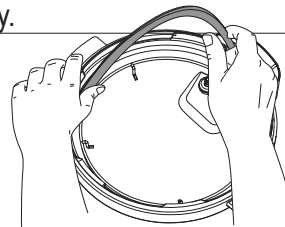

💡 Silicone is porous, so it absorbs strong aromas and certain flavours. Keep extra sealing rings on hand to limit the transfer of aromas and flavours between dishes.

⚠ CAUTION

Only use authorised Instant Pot sealing rings. **DO NOT** use a stretched or damaged sealing ring.

- Always check for cuts, deformation and correct installation of the sealing ring before cooking.
- Sealing rings stretch over time with normal use. The sealing ring should be replaced every 12–18 months or sooner if you notice stretching, deformation, or damage.

Failure to follow these instructions may cause food to discharge, which may lead to personal injury or property damage.

Pressure control features

Float valve

The float valve is a visual indication of whether there is pressure in the multicooker (pressurised) or not (depressurised). It appears in two positions:

Pressurised

The float valve has visibly popped up and is flush with the lid.

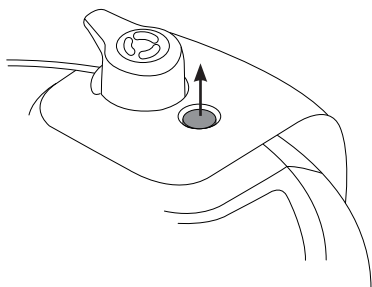

Depressurised

The float valve has descended into the lid.

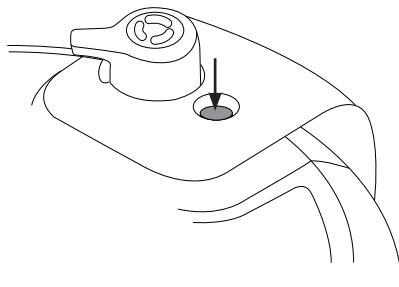

The float valve and silicone cap work together to seal in pressurised steam. These parts must be installed before use. Do not attempt to operate the Instant Pot without the float valve properly installed. **Do not touch the float valve during use.**

⚠ DANGER

DO NOT attempt to remove the lid while the float valve is up and NEVER attempt to force the lid open. Contents are under extreme pressure. Float valve must be down before attempting to remove the lid. Failure to follow these instructions may result in serious personal injury and/or property damage.

Anti-block shield

The anti-block shield prevents food particles from coming up through the steam release pipe, assisting with pressure regulation.

The anti-block shield is integral to product safety and necessary for pressure cooking.

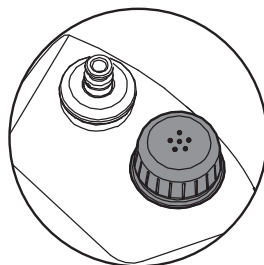

Illustrations in this document are for reference only and may differ from the actual product. Always refer to the actual product.

Pressure cooking

Whether you're a whiz in the kitchen or a complete newbie, these Smart Programmes help get you cooking with the touch of a button.

- Soup/Broth
- Meat/Stew
- Bean/Chili
- Poultry*
- Rice
- Multigrain*
- Porridge
- Steam
- Pressure Cook



*Not available on 3L model.
Use Pressure Cook instead.

Using pressurised steam guarantees your dish is cooked evenly and deeply, for the delicious results you expect every time.

Pressure level	Suggested use	Notes
Low Pressure 5.8 - 7.2 psi (35-55 kPa)	Fish and seafood, soft vegetables and rice.	The pressure level controls the temperature, so a higher pressure results in a higher cooking temperature.
High Pressure 10.2 - 11.6 psi (65-85 kPa)	Eggs, meat, poultry, root vegetables, oats, beans, grains, bone broth, stew, chili.	

⚠ CAUTION

To avoid scorching or scalding injury, be cautious when cooking with more than 1/4 cup (60 mL) oil, oil-based sauces, condensed cream-based soups, and thick sauces. Add suitable liquid to thin sauces. Avoid recipes that call for more than 1/4 cup (60 mL) of oil or fat content.

⚠ WARNING

Always cook with the inner pot in place. Food must be placed in the inner pot. **DO NOT pour food or liquid into the multicooker base.**

To avoid risk of personal injury and/or property damage, place food and liquid ingredients in the inner pot, then insert the inner pot into the multicooker base.

Do not fill inner pot higher than the **PC MAX — 2/3** (Pressure Cooking Maximum) line as indicated on the inner pot.

When cooking foods that **foam or froth** (e.g., applesauce, cranberries or split peas) or **expand** (e.g., oats, rice, beans, pasta) do not fill the inner pot higher than the **— 1/2** line as indicated on the inner pot.

⚠ CAUTION

Always inspect the lid and inner pot carefully to make sure they are clean and in good working condition before use.

- To avoid personal injury or damage to the appliance, replace the inner pot if it is dented, deformed or damaged.
- Use only authorised Instant Pot inner pots made for this model when cooking.

Always make sure the inner pot and heating element are clean and dry before inserting the inner pot into the multicooker base.

Failure to follow these instructions may damage the multicooker. Replace damaged parts to make sure safe function.

Pressure cooking

To create steam, pressure cooking liquids should be water-based, such as broth, stock, soup or juice. If using canned, condensed or cream-based soup, add water as directed below.

Instant pot size	Minimum liquid for pressure cooking
3 Litres	1 cup (250 mL)
5.7 Litres	1½ cup (375 mL)
8 Litres	2 cups (500 mL)

**Unless otherwise specified by your recipe.*

Jump start magic!

Stage 1: Setting up the Duo for pressure cooking

- 01 Remove the inner pot from the multicooker base.
Add food and liquid ingredients to the inner pot, as directed by your recipe.
 Use the steam rack to keep foods out of the cooking liquid. This helps to distribute heat, prevents nutrients from leeching into the cooking liquid, and, stops food items from sticking to the bottom of the inner pot.
Insert the inner pot back into the multicooker base.
- 02 **3L & 5.7L models:** Secure the power cord to the base power socket on the back of the multicooker base. Make sure the connection is tight.
All models: Connect the power cord to a 220-240V power source.
The display shows **OFF**.
- 03 Place and close the lid as described in **Pressure control features: multicooker lid**.
- 04 Turn the steam release handle to the **Sealing** position.

Stage 2: Pressure cooking

- 01 Select the Smart Programme you want to use.
- 02 Press the same Smart Programme button again to cycle through the preset time options in **Less, Normal** and **More**.
- 03 Use the **- / +** buttons to adjust the cooking time.
 Adjustments are saved to the Smart Programme when cooking begins.
- 04 Press **Pressure Level** to toggle between **Low Pressure** and **High Pressure**.
- 05 Leave the automatic Keep Warm setting on, or press **Keep Warm** to turn it off.
- 06 The multicooker beeps after 10 seconds, and the display shows **On** as the multicooker preheats.
- 07 When the Smart Programme finishes, follow your recipe's directions to select the appropriate venting method. See **Releasing pressure: Venting methods** for safe venting techniques.

DANGER

DO NOT attempt to remove the lid while the float valve is up and NEVER attempt to force the lid open. Contents are under extreme pressure. Float valve must be down before attempting to remove the lid. Failure to follow these instructions may result in serious personal injury and/or property damage.

Pressure cooking

Smart programme breakdown

Smart Programmes		Settings and defaults		
Soup/Broth	Pressure	Low (35-55 kPa / 5-8 psi) High (65-85 kPa / 9.4-12.3 psi)		
	Setting	Less	Normal	More
	Default cooking time (adjustable)	20 minutes (00:20)	30 minutes (00:30)	4 hours (04:00)
	Cooking time range	1 minute to 4 hours (00:01-04:00)		
Meat/Stew	Pressure	Low (35-55 kPa / 5-8 psi) High (65-85 kPa / 9.4-12.3 psi)		
	Setting	Less	Normal	More
	Default cooking time (adjustable)	20 minutes (00:20)	35 minutes (00:35)	45 minutes (00:45)
	Cooking time range	1 minute to 4 hours (00:01-04:00)		
Bean/Chili	Pressure	Low (35-55 kPa / 5-8 psi) High (65-85 kPa / 9.4-12.3 psi)		
	Setting	Less	Normal	More
	Default cooking time (adjustable)	25 minutes (00:25)	30 minutes (00:30)	40 minutes (00:40)
	Cooking time range	1 minute to 4 hours (00:01-04:00)		
Poultry*	Pressure	Low (35-55 kPa / 5-8 psi) High (65-85 kPa / 9.4-12.3 psi)		
	Setting	Less	Normal	More
	Default cooking time (adjustable)	5 minutes (00:05)	15 minutes (00:15)	30 minutes (00:30)
	Cooking time range	1 minute to 4 hours (00:01-04:00)		
Rice	Pressure	Low (35-55 kPa / 5-8 psi) High (65-85 kPa / 9.4-12.3 psi)		
	Setting	Less	Normal	More
	Default cooking time (adjustable)	8 minutes (00:08)	12 minutes (00:12)	15 minutes (00:15)
	Cooking time range	The cook time adjusts automatically depending on the volume of rice: 8 to 15 minutes. Display shows Auto .		

Pressure cooking

Smart programme breakdown

Smart Programmes		Settings and defaults		
Multigrain*	Pressure	Low (35-55 kPa / 5-8 psi) High (65-85 kPa / 9.4-12.3 psi)		
	Setting	Less	Normal	More
	Default cooking time (adjustable)	20 minutes (00:20)	40 minutes (00:40)	1 hour (01:00) + 45 minutes soaking time
	Cooking time range	1 minute to 4 hours (00:01-04:00)		
Porridge	Pressure	Low (35-55 kPa / 5-8 psi) High (65-85 kPa / 9.4-12.3 psi)		
	Setting	Less	Normal	More
	Default cooking time (adjustable)	5 minutes (00:05)	20 minutes (00:20)	30 minutes (00:30)
	Cooking time range	1 minute to 4 hours (00:01-04:00)		
Steam	Pressure	Low (35-55 kPa / 5-8 psi) High (65-85 kPa / 9.4-12.3 psi)		
	Setting	Less	Normal	More
	Default cooking time (adjustable)	3 minutes (00:03)	10 minutes (00:10)	15 minutes (00:15)
	Cooking time range	1 minute to 4 hours (00:01-04:00)		
Pressure Cook	Pressure	Low (35-55 kPa / 5-8 psi) High (65-85 kPa / 9.4-12.3 psi)		
	Setting	Less	Normal	More
	Default cooking time (adjustable)	20 minutes (00:20)	35 minutes (00:35)	45 minutes (00:45)
	Cooking time range	1 minute to 4 hours (00:01-04:00)		

*Not available on Duo 3L models. Use Pressure Cook instead.

Pressure cooking

Pressure cooking tips

Smart Programme	Setting	What it's for	Tips
Soup/Broth	Less	Soup without meat.	Liquid remains clear due to lack of boiling motion.
	Normal	Soup with meat.	Always use NR to release pressure when cooking soup with a high starch content.
	More	Rich bone broth.	
Meat/Stew	Less	Soft texture.	Choose setting based on meat texture desired, or adjust cook time manually.
	Normal	Very soft texture.	Allow meat to "rest" for 5-30 minutes, depending on size. It will retain cooking juices for tender, succulent meat.
	More	Fall-off-the-bone texture.	
Bean/Chili	Less	Firmer texture.	Choose setting based on bean texture desired, or adjust cook time manually.
	Normal	Soft texture.	When cooking beans or legumes, always use NR to release pressure.
	More	Very soft texture.	
Poultry*	Less	Soft texture.	Choose setting based on poultry texture desired or adjust cook time manually.
	Normal	Very soft texture.	Allow poultry to "rest" for 5-30 minutes, depending on size. It will retain cooking juices for tender, succulent meat.
	More	Fall-off-the-bone texture.	
Rice	Less	Tender but firm to bite.	For cooking medium and long-grain white rice.
	Normal	Normal texture white rice.	Depending on the volume of rice, cook time may range from 8-15 minutes.
	More	Softer texture white rice.	Use a 10-minute Natural Release after cooking for perfect results.

Pressure cooking

Pressure cooking tips

Smart Programme	Setting	What it's for	Tips
Multigrain*	Less	Brown rice, wild rice, black beans, chickpeas, etc.	Select Less or Normal based on type of grain and desired texture. More begins with 45 minutes of warm water soaking time prior to 60 minutes of pressure cooking.
	Normal	Brown rice, wild rice, mung beans, etc.	
	More	Tough grains or a mixture of grains and beans.	
Porridge	Less	Oatmeal—steel cut or rolled.	Adjust time as directed in recipe. Always use NR to release pressure when cooking foods that expand.
	Normal	White rice, porridge or congee.	
	More	Rice, porridge or congee with a mixture of various grains.	
Steam	Less	Vegetables.	Use steam rack provided to elevate food from cooking liquid. Use QR to release pressure to prevent food from overcooking.
	Normal	Fish and Seafood.	
	More	Meat.	
Pressure Cook	NA	Manual programming.	Press Pressure Level to toggle between High and Low pressure. Use - / + buttons to adjust cook time. Adjust according to recipe or desired results.

* Not available on 3L model. Use Pressure Cook instead.

Pressure cooking

Pressure cooking grains

Download the free Instant Brands Connect app to search recipes, save favourites, make notes and more!

Rice and grain	Grain to water ratio
White or brown rice	1 cup : 1 cup
Quinoa	1 cup : 3/4 cup
Oatmeal	1 cup : 3 cups
Risotto	1 cup : 2 cups Add additional wine to taste
Porridge	1 cup : 10 cups

CAUTION

When cooking meat, always use a meat thermometer to ensure the internal temperature reaches a safe minimum temperature.

Other cooking styles

The Duo is much more than a multicooker. These Smart Programmes don't cook with pressure, but are just as easy to use.

- Slow Cook
- Sauté
- Yogurt



Always inspect your Instant Pot multicooker lid, inner pot and multicooker base carefully to make sure they are clean and in good working condition before use.

⚠ WARNING

Always cook with the inner pot in place. Food must be placed in the inner pot. **DO NOT pour food or liquid into the multicooker base.**

To avoid risk of personal injury and/or property damage, place food and liquid ingredients in the inner pot, then insert the inner pot into the multicooker base.

Do not fill inner pot higher than the **PC MAX** — **2/3** (Pressure Cooking Maximum) line as indicated on the inner pot.

When cooking foods that **foam or froth** (e.g., applesauce, cranberries or split peas) or **expand** (e.g., oats, rice, beans, pasta) do not fill the inner pot higher than the — **1/2** line as indicated on the inner pot.

⚠ CAUTION

Always inspect the lid and inner pot carefully to make sure they are clean and in good working condition before use.

- To avoid personal injury or damage to the appliance, replace the inner pot if it is dented, deformed or damaged.
 - Use only authorised Instant Pot inner pots made for this model when cooking.
- Always make sure the inner pot and heating element are clean and dry before inserting the inner pot into the multicooker base.

Failure to follow these instructions may damage the multicooker. Replace damaged parts to make sure safe function.

Other cooking styles

Slow Cook

Slow Cook is compatible for use with any common slow cooker recipe, so you can keep cooking your classics!

 The float valve should not rise during Slow Cook. The lid is removable throughout the cooking process for easy access. If the float valve rises, make sure the steam release handle is set to the **Venting** position. See to **Pressure control features: Steam release handle**.

Setting	Suggested Use	Notes
Less	Low setting on common slow cookers.	Less is commonly used for low and slow, all-day cooking, and should be set for a minimum of 10 hours (10:00) for best results.
Normal	Medium setting on common slow cookers.	
More	High setting on common slow cookers.	You can use a glass lid for slow cooking if it has a venting hole.

Stage 1: Setting up the Duo for slow cooking

- 01** Remove the inner pot from the multicooker base.
Add food and liquid ingredients to the inner pot.
Insert the inner pot into the multicooker base.
- 02** **3L & 5.7L models:** Secure the power cord to the base power socket on the back of the multicooker base. Make sure the connection is tight.
All models: Connect the power cord to a 220-240V power source.
The display shows **OFF**.
- 03** Place and close the lid as described in **Pressure control features: multicooker lid**, or use a glass lid with a venting hole.
- 04** Turn the steam release handle to the **Venting** position.

Stage 2: Slow cooking

- 01** Press **Slow Cook**.
- 02** Press **Slow Cook** again to cycle through the preset temperature options in **Less**, **Normal** and **More**.
- 03** Use the **- / +** buttons to adjust the cooking time.
 Cooking time and temperature level adjustments are saved to the Smart Programme when cooking begins.
- 04** Leave the automatic **Keep Warm** setting on, or press **Keep Warm** to turn it off.
- 05** After 10 seconds, cooking begins and the display timer counts down.
When cooking completes, the display shows **End** if **Keep Warm** is turned off. If not, the timer begins counting from **00:00** up to 10 hours (**10:00**).

Other cooking styles

Sauté

Sauté can be used in place of a frying pan, griddle or flat-top grill.

Setting	Suggested Use	Notes
Less	Simmering, thickening and reducing liquids.	The display switching from Hot to On indicates the multicooker is maintaining the cooking temperature. As a safety precaution, 30 minutes is the maximum cooking time.
Normal	Pan searing or sautéing.	
More	Stir-frying or browning meat.	

Stage 1: Setting up the Duo for sautéing

- 01** Insert the inner pot into the multicooker base. **Do not use a lid.**
 - 02 3L & 5.7L models:** Secure the power cord to the base power socket on the back of the multicooker base. Make sure the connection is tight.
All models: Connect the power cord to a 220-240V power source.
The display shows **OFF**.
 - 03** Press **Sauté**.
 - 04** Press **Sauté** again to cycle through the preset temperature options in **Less**, **Normal** and **More**.
 - 05** Use the **- / +** buttons to adjust the cooking time.
Cooking time and temperature level adjustments are saved to the Smart Programme when cooking begins.
-  After 10 seconds, the multicooker displays **On** to indicate that it has begun heating.

Stage 2: Sautéing

- 07** When the display switches from **On** to **Hot**, add ingredients as directed by your recipe.
 If recipe ingredients are added before the Hot message appears, it may not appear at all. This is normal!
- 08** If you finish sautéing before the timer runs out, press **Cancel**. Otherwise, when cooking finishes the display shows **End**.

Delay Start and Automatic Keep Warm are not available on the Sauté Smart Programme.

Other cooking styles

Deglazing the inner pot (pressure cooking after sauté)

Sautéing meat and vegetables before pressure cooking is the perfect way to boost flavours, as sugars caramelize from the high heat of the Sauté Smart Programme.

When pressure cooking after using Sauté, deglaze the inner pot to make sure food items do not scorch.

To deglaze: Remove food items from the inner pot and add a thin liquid (e.g., water, broth, wine) to the hot surface. Use a wooden or silicone scraper to loosen anything that may be stuck to the bottom of the inner pot.

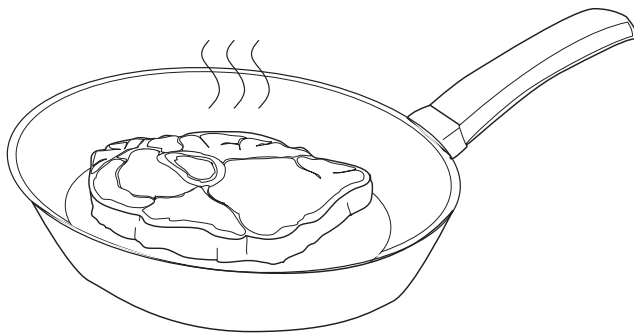

⚠ WARNING

The Sauté Smart Programme reaches high temperatures. If unmonitored, food may burn on this setting. Do not use the lid and do not leave your multicooker unattended while using Sauté.

Other cooking styles

Yogurt

Yogurt is designed to effortlessly produce delicious fermented dairy and non-dairy recipes.

Instant Pot Size	Minimum Milk Volume	Maximum Milk Volume
3 Litres	2 cups (500 mL)	1.9 Litres
5.7 Litres	4 cups (1 L)	3.8 Litres
8 Litres	6 cups (1.5 L)	5.8 Litres

Setting	Suggested Use	Notes
Less	For lower temperature fermentation (e.g., Jiu Niang, a sweet fermented glutinous rice dessert).	Default fermentation time is 24 hours (24:00) . Adjust fermentation time based on recipe.
Normal	Fermenting milk after culture has been added.	A longer fermentation will result in tangier yogurt. Adjust as desired up to 99 hours and 30 minutes (99:30).
More	Pasteurising milk.	Pasteurisation time is preset and cannot be adjusted. Display shows boiL while pasteurisation is running. For extra thick yogurt, pasteurise milk twice!

Stage 1: Pasteurise milk

- 01 Remove the inner pot from the multicooker base.
- 02 Add unpasteurised milk to the inner pot then insert the inner pot into the multicooker base.
- 03 **3L & 5.7L models:** Secure the power cord to the base power socket on the back of the multicooker base. Make sure the connection is tight.
All models: Connect the power cord to a 220-240V power source.
The display shows **OFF**.
- 04 Place and close the lid as described in **Pressure control features: multicooker lid**.
- 05 Turn the steam release handle to the **Venting** position.
- 06 Press **Yogurt**.
- 07 Press **Yogurt** again and cycle to **More**. The display shows **boiL**.
- 08 After 10 seconds the multicooker begins heating.
- 09 When pasteurisation finishes, the display shows **End**.
Remove the lid and use a thermometer to check the temperature.



Milk must reach a minimum of 72°C for pasteurisation to occur.

Other cooking styles

Stage 2: Add starter culture

- 01** Allow pasteurised milk to cool to just below 43°C.
- 02** Add a starter culture to the milk according to package instructions.
-  If using plain yogurt as a starter, make sure that it contains an **active culture**. Mix in 30 mL (2 tbsp) of yogurt per 3.7 L of milk, or follow a trusted recipe.
- 03** Place and close the lid as described in **Pressure control features: multicooker lid**.

Stage 3: Ferment yogurt

- 01** Press **Yogurt**.
- 02** Press **Yogurt** again and cycle to **Normal**. The display shows 8 hours (**08:00**).
- 03** Use the **- / +** buttons to adjust the fermentation time if desired.
-  A longer fermentation period will give you tangier yogurt.
- 04** After 10 seconds the multicooker begins heating. The display timer counts up to the set time from **00:00**.
- 05** When fermentation completes, the multicooker beeps and displays **End**.

 Allow the yogurt to cool, then place in in your fridge for 12 to 24 hours to allow the flavours to develop!

Using yogurt cups

Yogurt cups are a convenient way to portion out yogurt servings.

- 01** After adding the starter culture to your pasteurised milk, carefully pour the milk into your yogurt cups and seal them tightly.
- 02** Clean the inner pot thoroughly and place the steam rack on the bottom of the inner pot.
- 03** Place the sealed yogurt cups on the steam rack and add water to the inner pot until the cups are submerged halfway.
- 04** Follow the steps in **Stage 3: Ferment Yogurt**.

Care, cleaning and storage

Clean your Duo and its parts after each use. Failure to follow these cleaning instructions may result in catastrophic failure, which may lead to property damage and/or severe personal injury.

Always unplug your multicooker and let it cool to room temperature before cleaning. Never use metal scouring pads, abrasive powders or harsh chemical detergents on any of the Instant Pot's parts or accessories.

Let all surfaces dry thoroughly before use, and before storage.

Parts	Cleaning methods and instruction
Accessories <ul style="list-style-type: none"> • Steam rack 	Dishwasher safe if placed on the top rack.
Lid and parts <ul style="list-style-type: none"> • Condensation collector • Anti-block shield • Sealing ring • Steam release handle • Float valve • Silicone cap 	Dishwasher safe if placed on the top rack. Remove all the parts from the lid before cleaning. See Care, cleaning and storage: Removing and installing parts. <ul style="list-style-type: none"> • Check the condensation collector after each use and empty as needed. Do not allow food or moisture to stagnate in the condensation collector. • With steam release handle and anti-block shield removed, clean the interior of the steam release pipe to prevent clogging. • To drain water from the lid after dishwashing, grasp the lid handle and hold the lid vertically over a sink, then turn it 360°— such as turning a steering wheel. • After cleaning, store the lid upside down on the multicooker base. • Store sealing rings in a well-ventilated area to decrease residual odour of flavourful meals. To eliminate odours, add 1 cup (250 mL) water and 1 cup (250 mL) white vinegar to inner pot, and run Pressure Cook for 5-10 minutes, then QR pressure.
Inner pot	Dishwasher safe. <ul style="list-style-type: none"> • More acute hard water staining may require a vinegar-dampened sponge and some scrubbing to remove. • If there is tough or burned food residue at the bottom, soak in hot water for a few hours for easy cleaning. • Make sure all exterior surfaces are dry before placing in multicooker base.
Power cord (8L only) Detachable power cord (3L & 5.7L only)	Hand wash only. Do not machine wash. <ul style="list-style-type: none"> • Use a barely damp cloth to wipe any particles off the cord.
Multicooker base	Hand wash only. Do not dishwash. <ul style="list-style-type: none"> • Wipe the inside of the outer pot as well as the condensation rim with a barely damp cloth. Allow them to dry completely before inserting inner pot. • Clean multicooker base and control panel with a soft, barely damp cloth or sponge.

Some discolouration may occur after machine washing, but this will not affect the cooker's safety or performance.

Care, cleaning and storage

⚠ WARNING

The Instant Pot multicooker base contains electrical components. To avoid fire, electric leakage or personal injury, make sure the multicooker base stays dry.

- DO NOT immerse the multicooker base in water or other liquid, or attempt to cycle it through the dishwasher.
- DO NOT rinse the heating element.
- DO NOT submerge or rinse the power cord or the plug.

Removing and installing parts

Silicone sealing ring

Remove the sealing ring

Grip the edge of the silicone and pull the sealing ring out from behind the circular stainless steel-sealing ring rack.

With the sealing ring removed, inspect the steel rack to make sure it is secured, centered, and at an even height all the way around the lid. Do not attempt to repair a deformed sealing ring rack.

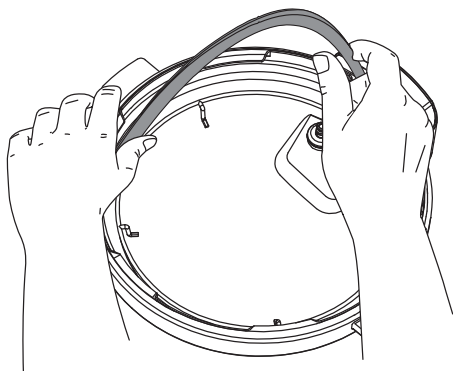

Install the sealing ring

Place the sealing ring over the sealing ring rack and press it into place. Press down firmly to prevent puckering.

When installed properly, the sealing ring is snug behind sealing ring rack and should not fall out when the lid is turned over.

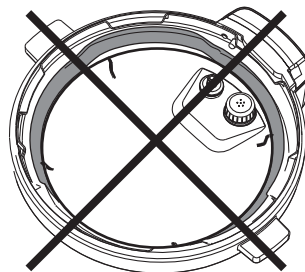
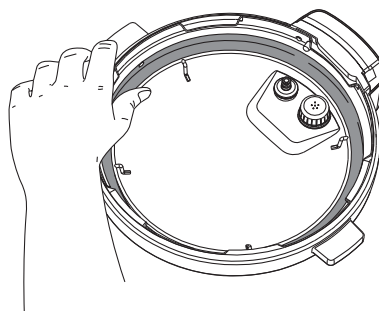

Incorrect

Illustrations in this document are for reference only and may differ from the actual product. Always refer to the actual product.

Care, cleaning and storage

Steam release handle

Remove the steam release handle

Pull the steam release handle up and off the steam release pipe.

The steam release handle must be installed before using the multicooker.

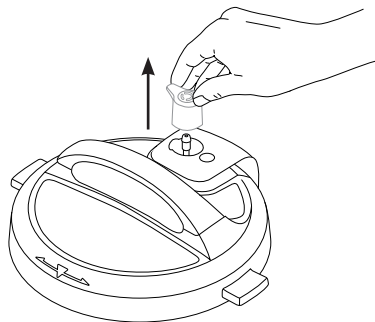

Install the steam release handle

Place the steam release handle on the steam release pipe and press down firmly.

The steam release handle sits loosely on the steam release pipe when installed properly but should remain in place when the lid is turned over.

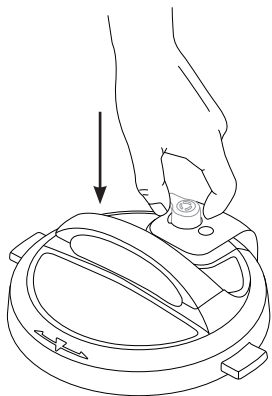

Anti-block shield

Remove the anti-block shield

Grip the lid like a steering wheel and use your thumbs to press firmly against the side of the anti-block shield (pressing towards the side of the lid and up) until it pops off the prongs underneath.

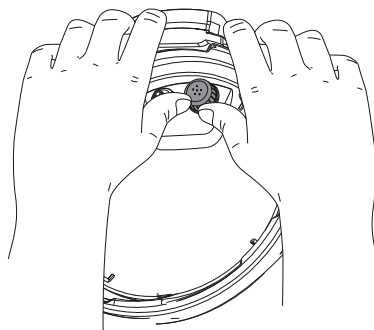

Remove

Install the anti-block shield

Place the anti-block shield over the prongs and press down until it snaps into position.

Do not attempt to operate the multicooker without the anti-block shield installed.

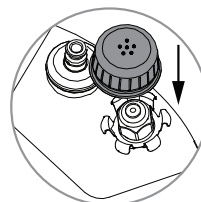

Install

Illustrations in this document are for reference only and may differ from the actual product. Always refer to the actual product.

Care, cleaning and storage

Float valve and silicone cap

Remove the float valve

Place one finger on the flat top of float valve, then turn the lid over. Detach the silicone cap from the bottom side of the float valve. Remove the float valve from the top of the lid.

 Do not discard the float valve or silicone cap.

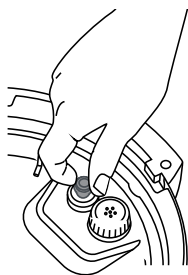

Top of lid

Install the float valve

Drop the narrow end of the float valve into the float valve hole on the top of the lid. Place one finger on the flat top of the float valve, then turn the lid over. Firmly attach the silicone cap to the bottom of the float valve.

Do not attempt to operate the multicooker without the float valve and/or silicone cap properly installed in the multicooker lid.

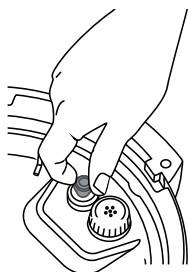

Bottom of lid

Condensation collector

The condensation collector sits at the back of the multicooker base and catches any overflow from the condensation rim.

It should be installed before cooking, then emptied and rinsed out after each use.

Remove the condensation collector

Pull the condensation collector away from the multicooker base; **do not pull down**. Note the tabs on the multicooker base and the grooves on the condensation collector.

Install the condensation collector

Align the grooves on the condensation collector over the tabs on the back of the multicooker base and slide the condensation collector into place.

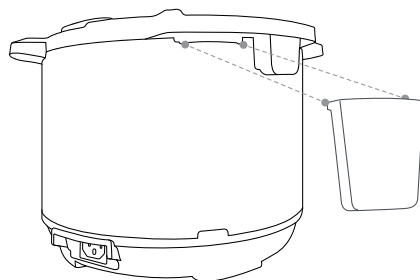

Illustrations in this document are for reference only and may differ from the actual product.

Always refer to the actual product.

Troubleshooting

Register your Instant Pot Duo today at instantpot.com.au/support/register.

Get in touch with Customer Care by email at support@instantpot.com.au or by phone at **1800 251 643** or **(02) 9317 1000**.

Problem	Possible reason	Try this
Occasional clicking or light cracking sound.	The sound of power switching and the pressure board expanding when changing temperatures.	This is normal; no action needed.
	Bottom of the inner pot is wet.	Wipe exterior surfaces of the inner pot. Make sure the heating element is dry before inserting the inner pot back into the multicooker base.
Difficulty closing the lid.	Sealing ring is not properly installed.	Reposition the sealing ring. Make sure it is snug behind the sealing ring rack.
	Float valve is in the popped-up position.	Gently press the float valve downward with a long utensil.
	Contents in multicooker are still hot.	Turn the steam release handle to the Venting position, then lower the lid onto the multicooker base slowly, allowing heat to dissipate.
Difficulty opening the lid.	Pressure inside the multicooker.	Release pressure according to recipe. Only open the lid after the float valve has dropped down.
	Float valve stuck in the popped-up position due to food debris or residue.	Make sure steam is completely released by quick releasing pressure, then press the float valve gently with a long utensil. Open the lid cautiously, then thoroughly clean the float valve, surrounding area, and lid before next use.
	⚠ DANGER Contents may be under pressure. To avoid scalding injury, DO NOT attempt to force the lid open.	
The inner pot is stuck to the lid when the multicooker is opened.	Cooling of the inner pot may create suction, causing the inner pot to adhere to the lid.	To release the vacuum, turn the steam release handle to the Venting position.
Steam gushes from the steam release handle when it is in the Sealing position.	Not enough liquid in the inner pot.	Add thin, water-based liquid to the inner pot according to its size. 3L: 1 cup (250 mL) 5.7L: 1 ½ cups (375 mL) 8L: 2 cups (500 mL)
	Pressure sensor control failure.	Contact Customer Care .
	Steam release handle is not seated properly.	Turn the steam release handle to the Sealing position.

Troubleshooting

Problem	Possible reason	Try this
Steam leaks from side of lid.	No sealing ring in the lid.	Install a sealing ring.
	The sealing ring is damaged or not installed properly.	Replace the sealing ring.
	Food debris attached to the sealing ring.	Remove the sealing ring and clean it thoroughly.
	The lid is not closed properly.	Open, then close the lid.
	The sealing ring rack is warped or off-centre.	Remove the sealing ring from the lid, then check the sealing ring rack for bends or warps. Contact Customer Care .
	The inner pot rim may be misshapen.	Check for deformation and contact Customer Care .
The float valve does not rise.	Food debris on the float valve or float valve silicone cap.	Remove the float valve from the lid and clean it thoroughly. Perform the Initial test run to check for function and record your findings. Contact Customer Care .
	Too little liquid in the inner pot.	Check for scorching on the bottom of the inner pot. Add thin, water-based liquid to the inner pot according to its size. 3L: 1 cup (250 mL) 5.7L: 1 ½ cups (375 mL) 8L: 2 cups (500 mL)
	Float valve silicone cap damaged or missing.	Install or replace the float valve and/or silicone cap.
	Float valve obstructed by lid-locking mechanism.	Tap the float valve with a long utensil. If the float valve does not drop, turn the multicooker off. Contact Customer Care .
	No heat in the inner pot.	Perform the Initial test run to check for function and record your findings. Contact Customer Care .
	Inner pot base may be damaged.	Perform the Initial test run to check for function and record your findings. Contact Customer Care .
Minor steam leaking or hissing from the steam release handle during the cook cycle.	Steam release handle is not in the Sealing position.	Turn the steam release handle to the Sealing position.
	Multicooker is regulating excess pressure.	This is normal; no action required.

Troubleshooting

Problem	Possible reason		Try this
The display remains blank after connecting the power cord.	Bad power connection or no power.		Inspect power cord for damage. If damage is noticed, contact Customer Care . Check outlet to make sure it is powered.
	Cooker's electrical fuse has blown.		Contact Customer Care .
Error code appears on the display and the multicooker beeps continuously.	C1 C2 C6 C6H C6L	Faulty sensor.	Contact Customer Care .
	C5	Temperature is too high because the inner pot is not placed in the multicooker base.	Press Cancel and wait for heating element to cool; make sure there are no foreign objects in multicooker base; insert or reposition inner pot in multicooker base and re-enter commands.
		Temperature is too high.	Check for scorching on bottom of inner pot. Add thin, water-based liquid to the inner pot according to its size. 3L: 1 cup (250 mL) 5.7L: 1 ½ cups (375 mL) 8L: 2 cups (500 mL)
	C7 or NoPr	Heat element has failed.	Contact Customer Care .
		Not enough liquid.	Add thin, water-based liquid to the inner pot according to its size. 3L: 1 cup (250 mL) 5.7L: 1 ½ cups (375 mL) 8L: 2 cups (500 mL)
		Steam release handle is in the Venting position.	Turn the steam release handle to the Sealing position.
	Lid	Lid is not in the correct position for the selected programme.	Open and close the lid.
Do not use a lid when using Sauté.			
Error code appears on the display and the multicooker beeps continuously.	Food burn	High temperature detected at bottom of inner pot; multicooker automatically reduces the temperature to avoid overheating.	Starch deposits at the bottom of the inner pot may have blocked heat dissipation. Turn the multicooker off, release pressure according to the recipe, and inspect the bottom of the inner pot.
	PrSE	Pressure has accumulated during a non-pressure cooking programme.	Turn the steam release handle to the Venting position.

Any other servicing must be performed by an authorised representative.

Warranty

Limited Warranty

This Limited Warranty is issued by Corelle Brands (Australia) Pty Ltd (Corelle Brands Australia) and is effective for one year from the date of original consumer purchase. Proof of original purchase date and return of your appliance is required to obtain service under this Limited. Return of your appliance to us will be done in accordance with our instructions only. Provided that this appliance is operated and maintained in accordance with written operating instructions attached to or furnished with the appliance or published operating instructions on www.instantpot.com.au, Corelle Brands Australia will, in its sole and exclusive discretion, either: (i) repair defects in materials or workmanship; or (ii) replace the appliance. In the event that your appliance is replaced, the Limited Warranty on the replacement appliance will expire 12 months from the date of original consumer purchase.

We remind you the appliance you purchased is for personal use only (not commercial use).

Any modification/alteration or attempted modification/alteration to your appliance will void this Limited Warranty, unless such modification/alteration or attempted modification/alteration was expressly authorised by a Corelle Brands Australia Representative in writing.

This Limited Warranty only covers Corelle Brands Australia's appliances/products and is not extended to any other appliances, products, equipment, components, or devices that you use or may use in conjunction with the Corelle Brands Australia's appliances.

To claim under this Limited Warranty:

1. Contact Corelle Brands Australia at:
Sydney Corporate Park
Level 1, 184 Bourke Road, Alexandria, NSW 2015
Email: sales.australia@instantbrands.com
2. Provide a description of the appliance you believe has malfunctioned due to defective parts or workmanship.
3. If it is necessary for the appliance to be sent to Corelle Brands Australia for repair or replacement, Corelle Brands Australia will send you a pre-paid shipping label and you must send the appliance and your dated sales receipt to Corelle Brands Australia along with the appliance. If you do not have your dated sales receipt, please advise Corelle Brands Australia in advance, and Corelle Brands Australia will attempt to verify your purchase.
4. If Corelle Brands Australia determines that the appliance has malfunctioned due to defective parts or workmanship, and is covered under this Limited Warranty, Corelle Brands Australia will repair and return the appliance, or send you a replacement appliance, at Corelle Brands Australia's cost.
5. Any repaired or replaced appliance will be covered by this Limited Warranty for the remainder of the original warranty period or ninety (90) days following your receipt of the replacement or repaired appliance, whichever is greater.

Warranty

6. If Corelle Brands Australia confirms the appliance has not malfunctioned due to defective parts or workmanship, and/or is in working order, or if proof of purchase is not verified, Corelle Brands Australia reserves the right to return the appliance to you at your pre-paid cost. If this cost is not met, Corelle Brands Australia reserves the right to dispose of the appliance after 45 days' notice to you.

Limitation and Exclusions

To the maximum extent permitted by law, the maximum liability of Corelle Brands Australia, if any, for any allegedly defective appliance or part shall in no circumstances exceed the purchase price of a comparable replacement appliance or part of the same age.

This Limited Warranty does not cover:

Damage resulting from accident, modification/alteration (unless expressly authorised by a Corelle Brands Australia Representative in writing), misuse, abuse, neglect, unreasonable use, use contrary to the written operating instructions attached to or furnished with the appliance or published operating instructions on www.instantpot.com.au, normal wear and tear, commercial use, improper assembly by you or anyone, disassembly by you or anyone, repair by you or anyone, failure to provide reasonable and necessary maintenance, force majeure event including but not limited to fire, flood, acts of God;

Repairs where your appliance is used for other than normal, personal use or when it is used in a manner that is contrary to the written operating instructions attached to or furnished with the appliance or published operating instructions on www.instantpot.com.au ; or

Use of unauthorised parts and accessories, or repairs to parts and systems resulting from unauthorised repairs or modifications/alterations made to your appliance.

The cost of repair or replacement under these excluded circumstances shall be borne by you. Our goods come with guarantees that cannot be excluded under the Australian Consumer Law. You are entitled to a replacement or refund for a major failure and compensation for any other reasonably foreseeable loss or damage. You are also entitled to have the goods repaired or replaced if the goods fail to be of acceptable quality and the failure does not amount to a major failure.

Distributed by Corelle Brands (Australia) Pty Ltd.
Sydney Corporate Park
Level 1, 184 Bourke Road, Alexandria, NSW 2015.
1800 251 643 or (02) 9317 1000.
Email: sales.australia@instantbrands.com

©2022 Corelle Brands (Australia) Pty Ltd.
Distributed by Corelle Brands (Australia) Pty Ltd.

An Instant Brands Company.

Sydney Corporate Park
Level 1, 184 Bourke Road, Alexandria, NSW 2015, Australia.

instantpot.com.au

©2022 Instant Brands LLC.
801-0110-91