

*get started*

**INSTANT™ INFUSION BREW PLUS  
12-CUP COFFEE MAKER**

USER MANUAL

**Instant**

# Welcome

to your new Instant™ Infusion Brew Plus 12-Cup Coffee Maker!

Brew delicious, smooth coffee anytime you crave it, with maximum flavor and customisation in every cup. Here are some helpful resources as you get to know your new Instant™ appliance.

**Get started with your Instant™ Infusion Brew Plus!**



## **⚠️ WARNING**

Before using your Instant™ Infusion Brew Plus, read all instructions, including the Safety Information starting on page 2. Failure to follow the safeguards and instructions may result in personal injury and/or property damage. Keep this manual for reference.

## **CONTENTS**

Important safeguards	2
What's in the box	5
Using your Instant™ Infusion Brew Plus	6
Initial setup	7
Brewing coffee	11
Care, cleaning and storage	16
Troubleshooting	18
Learn more	20
Warranty	21

# **IMPORTANT SAFEGUARDS**

## **⚠️ WARNING**

### **Safety Instructions**

At Instant™, we want you to feel comfortable using our products. This Instant™ Coffee Maker was designed with you and your safety in mind.

*When using electrical appliances, basic safety precautions should always be followed to reduce the risk of fire, electric shock, personal injury/or property damage.*

**Read all instructions before using and only use this appliance as described in the in-box materials. Failure to follow these safeguards and instructions may result in personal injury and/or property damage, and can void your warranty.**

### **Placement**

- **DO** operate the appliance on a stable, non-combustible, level surface.
- **DO NOT** place the appliance on or near a hot gas or electric burner, or in a heated oven.
- **DO NOT** move the appliance while it is in operation.

### **General Use**

- **DO NOT** use this coffee maker outdoors.
- **DO NOT** fill past waterline
- **DO NOT** fill the water reservoir with mineral water, milk or other liquids. Only fill the water reservoir with clean, cold water.
- **DO NOT** let the coffee maker operate without water.
- **DO NOT** use the appliance for anything than its intended use. Not for commercial use. For household use only.
- **DO** regularly inspect the appliance and power cord.
- **DO NOT** leave the appliance exposed to sun, wind, and/or snow.
- **DO** operate and store the appliance above 32°F / 0°C
- **DO NOT** leave the appliance unattended when in use.
- **DO NOT** allow children to operate the appliance; close supervision is required when any appliance is used near children.
- **DO NOT** let children play with this appliance.
- To avoid the risk of burn injury **DO NOT** open the top cover during or immediately after the brew process. Contents may be extremely hot. Allow contents to cool before opening lid.

## **⚠ WARNING**

- **DO NOT** touch hot surfaces with unprotected hands.
- The use of an accessory not evaluated for use with this appliance may cause personal injuries and/or property damage.
- The container is designed for use with this appliance. It must never be used on a range top.
- **DO NOT** set a hot container on a wet or cold surface.
- **DO NOT** use a cracked container or a container having a loose or weakened handle.
- **DO NOT** clean container with cleansers, steel wool pads, or other abrasive material.

### **Care and Storage**

- **DO** unplug from outlet when not in use before cleaning. Allow the appliance to cool before putting on or taking off parts, and before cleaning the appliance.
- **DO NOT** store any materials in the brewing chamber when not in use.

### **Power Cord**

A short power-supply cord is used to reduce the risk resulting from it being grabbed by children, becoming entangled in, or tripping over a longer cord. Spilled liquids from this coffee maker can cause serious burns and/or property damage. Keep appliance and cord away from children.

Never drape cord over edge of counter and never use outlet below counter.

- **DO NOT** let the power cord touch hot surfaces or open flame, including the stovetop.
- **DO NOT** use with power converters or adapters, timer switches or separate remote-control systems.
- **DO NOT** let the power cord hang over the edge of tables or counters.
- **DO** unplug your coffee maker by grasping the plug and pull from the outlet. Never pull from the power cord.
- **DO NOT** attempt to modify the plug. If the plug does not fit full into the outlet, reverse the plug.
- **DO** contact a qualified electrician if the plug does not fit in the outlet.
- **DO NOT** attempt to modify the plug in any way. If it still does not fit, contact a qualified electrician.

## **⚠ WARNING**

### **Electrical Warning**

The coffee maker contains electrical components that are an electrical shock hazard. Failure to follow these instructions may result in electric shock.

To protect against electrical shock:

- To reduce the risk of fire, property damage, personal injury, and/or electric shock, do not remove the bottom cover. No user-serviceable parts inside. Repair should be done by authorised service personnel only.
- To disconnect, turn any control to the off position and remove plug from power source. Always unplug when not in use, as well as before adding or removing parts or accessories, and before cleaning. To unplug, grasp the plug and pull from the outlet. Never pull from the power cord.
- **DO** regularly inspect the appliance and power cord.
- **DO NOT** operate the appliance if the power cord or plug is damaged, or after the appliance malfunctions or is dropped or damaged in any manner. For assistance, contact Customer Care by email at [supportau.instant@instantbrands.com](mailto:supportau.instant@instantbrands.com)
- **DO NOT** attempt to repair, replace or modify components of the appliance, as this may cause property damage, electric shock, fire or personal injury, and will void the warranty.
- **DO NOT** tamper with any of the safety mechanisms, as this may result in personal injury or property damage.
- **DO NOT** immerse power cord, plug or the appliance in water or other liquid.
- **DO NOT** use the appliance in electrical systems other than 220-240V~, 50-60Hz.
- A longer detachable power-supply cord or extension cord may be used with the following precautions:
  - The marked electrical rating of the detachable power-supply cord or extension cord should be at least as great as the electrical rating of the appliance.
  - The longer cord should be arranged so that it will not drape over the countertop or tabletop where it can be pulled on by children or tripped over.

# **SAVE THESE INSTRUCTIONS**

## WHATS IN THE BOX

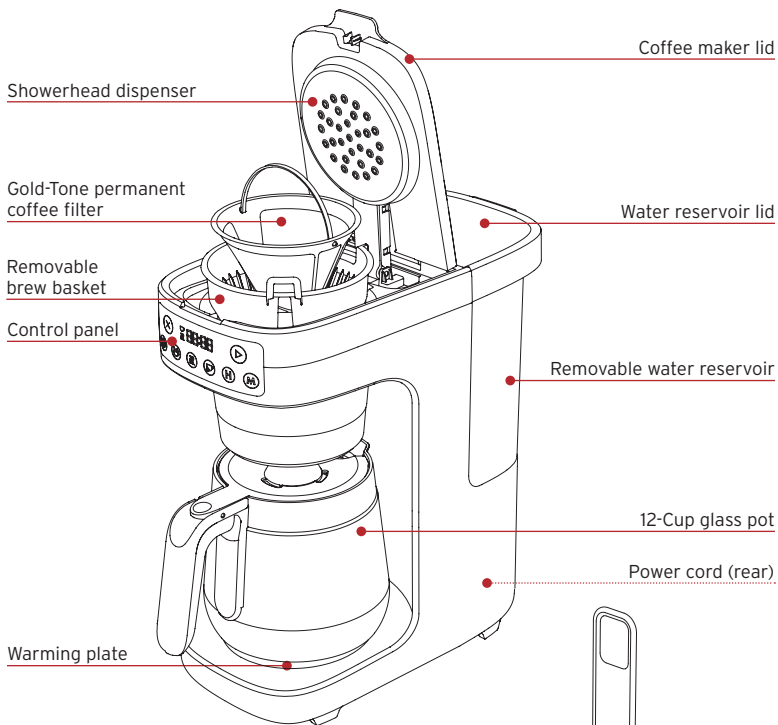

## Accessories

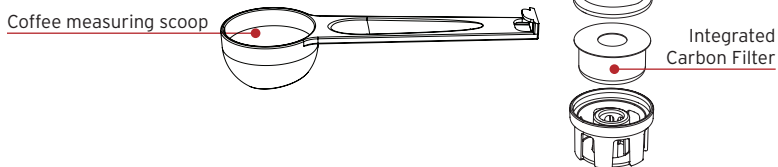

*Illustrations are for reference only and may differ from the actual product.*

## Remember to recycle!

We designed our packaging with sustainability in mind. Be sure to recycle at a recycling center in your area.

## USING YOUR INSTANT™ INFUSION BREW PLUS

### Control panel

We've designed the control panel to be simple and easy to read.

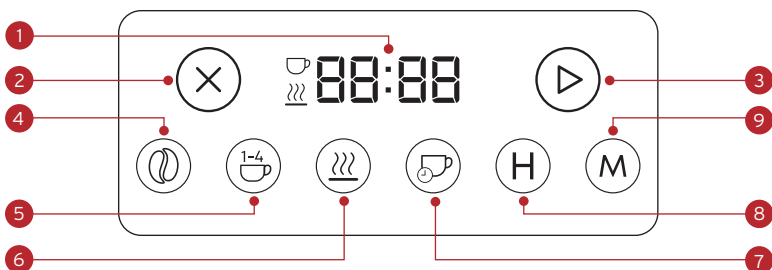

1. Clock/ display
2. Cancel
3. Start
4. Bold setting
5. Small batch (1-4 cups)

6. Warming Plate
7. Auto-Brew/Timer
8. Hours
9. Minutes



## INITIAL SETUP

1. Pull the Instant™ Infusion Brew Plus and all accessories out of the box.
2. Remove all packaging materials from within and around the unit.
3. Place the unit on a dry, stable and level surface.
4. Plug in your Instant™ Infusion Brew Plus.
5. You will hear a beep and all display LED buttons will light up.

*Note: After 30 minutes of inactivity, your coffee maker will enter standby mode. The LED control panel will dim. To exit standby mode, press any button or lift the coffeemaker lid.*

### Sound Settings

You can turn sound and reminder beeps on or off. The default sound setting when you open your coffee maker is ON.

1. Make sure your Instant™ Infusion Brew Plus is on.
2. To turn sound off, press and hold the **Bold** and **Small Batch** buttons at the same time for 2 seconds. The message display will show **SOFF**.
3. To turn sound back on, repeat step 2. The message display will show **S On**.

### Setting the Clock

When you first turn on your Instant™ Infusion Brew Plus, the clock display will show the default time of 12:00 AM. Setting and changing the time is quick and easy.

1. Make sure your Instant™ Infusion Brew Plus is turned on.
2. Press the **(H)** and **(M)** buttons until the correct time is set. To speed up, press and hold for 3 seconds.
3. Press **(D)** button to save the new time.
4. Your clock is now set!

## Clean before use

1. Lift the water reservoir up to remove from the coffee maker.
2. Handwash the glass pot, water reservoir, coffee filter and brew basket with warm water and dish soap. Rinse with warm, clear water. Wipe with a clean, dry cloth.
3. With a damp cloth, wipe down the coffee maker base and control panel.

## Integrated Carbon Filter

The integrated carbon filter ensures your water is free of chlorine and other impurities before brewing for cleaner, tastier coffee. The filter cartridge contains activated charcoal and should be replaced every 60 days for the best results. Replacement filters can be purchased from [instantbrands.com.au](http://instantbrands.com.au).

You will need to assemble and install the integrated carbon filter that comes with your machine before your first brew.

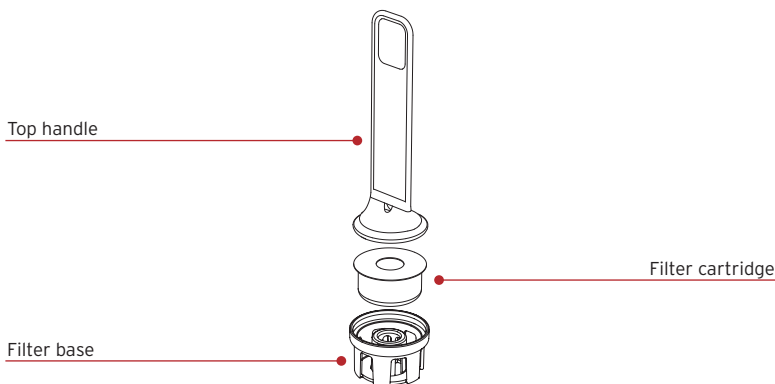

### To assemble:

1. Remove the **filter base**, **top handle** and **filter cartridge** from its packaging.
2. Soak the **filter cartridge** in cool water for 10 minutes to activate it before using.
3. Place the fully soaked **filter cartridge** into the **filter base**.

4. Snap the **top handle** to the **filter base** to fully enclose the **filter cartridge**.

#### To install:

1. Place the assembled Integrated **carbon filter** into the **water reservoir**.
2. Press the **integrated carbon filter** into the port at the bottom of the **water reservoir** until it is firmly in place.



#### To replace the filter cartridge:

1. Pull the **top handle** to remove the **integrated carbon filter** from the **water reservoir**.
2. Unsnap the **top handle** from the **filter base** to remove the old **filter cartridge** and replace with a new one. See assembly instructions above.

*Always soak your new **filter cartridge** in water for 10 minutes before using for best results.*

#### Test Run

Before you brew your first pot of coffee, we recommend flushing your Instant™ Infusion Brew Plus to make sure the unit is clean and working correctly. **Do not use coffee for the test run.**

1. Remove the **water reservoir lid**. Lift the **water reservoir** from the back of the coffee maker.
2. Fill the **water reservoir** with cold water to the 12-cup fill line as indicated. *Be careful not to over-fill.*
3. Place the **water reservoir** back onto the coffee maker then replace **water reservoir lid**.
4. Place the **glass pot** onto the **warming plate**, under the **removable brew basket**.
5. Ensure the **coffee maker lid** is closed. The  button should light up. Press  button to begin brewing.

6. After the brewing cycle ends, the keep warm setting will automatically activate and the **warming plate** will stay hot for 2 hours. Press the ⊗ button or the @ button to turn it off.
7. Carefully remove the **glass pot** and discard the water.  
**CAUTION: The water and warming plate will be hot.**

*To stop brewing at any time press the ⊗ button.*

8. Carefully place the **glass pot** back on to the **warming plate** which may still be hot.
9. Your test run is complete and you're ready to start brewing!

## BREWING COFFEE

Once you've cleaned your Instant™ Infusion Brew Plus and all parts, and completed a test run, it's time to program your perfect brew.

### Brewing the Perfect Coffee

Water	Coffee	Grind	Ratio
Coffee is 98% water. Use great tasting, cool, filtered water for the purest tasting coffee.	The tastiest, high-quality beans make the tastiest, smoothest coffee. Store whole beans in a cool place (or freezer) and grind just before brewing.	For the most flavourful coffee, choose a medium-fine grind when brewing with your Instant™ Infusion Brew Plus. If you grind your own beans, grind just before brewing for maximum freshness.	Getting water to coffee ratios correct is key to great tasting brew that isn't too weak or too strong. See coffee measurements guide to start, then adjust to your personal taste.

### Pre-Infusion Process

Your Instant™ Infusion Brew Plus uses an innovative showerhead dispenser and pre-infusion process to extract maximum flavour with every brew. Pre-infusion gently soaks the ground coffee evenly with filtered water before brewing. Pre-infusion begins automatically during all brewing programs with your Instant™ Infusion Brew Plus.

### Brew Preferences and Programs

Your Instant™ Infusion Brew Plus lets you choose how you want to brew for maximum taste and customisation, and tasty coffee every time.

## Ⓛ **Bold Brew**

If you prefer a stronger, richer coffee, the Bold Brew setting has been programmed to extract even deeper flavour from the coffee grounds by increasing the brewing time slightly.

*The Bold Brew button will illuminate when selected.*

You can toggle between Classic and Bold Brew settings depending on your personal preference.

For brew that tastes...	Choose this brew strength
Medium flavour, easy drinking, balanced. Great morning coffee.	Classic
Deep, rich flavour, smooth. Holds up well to cream/milk and other flavourings.	Bold

## Ⓟ **Auto-Brew Timer**

Set your timer before bed and wake up to perfectly brewed coffee ready for you to enjoy! You can set your brew to automatically start, up to 24 hours in advance.

- Make sure the clock is set to the current time. See 'Setting the Clock' on page 7.
- Press the Ⓟ button then press the Ⓜ and Ⓟ buttons to set the brew time you want.
- Press Ⓟ. The Ⓟ button will illuminate and a tone will play confirming the new brew time is set.

## Ⓡ **Small Batch Brewing**



Use this setting when you are brewing fewer than 4 cups of coffee. Small batch brewing adjusts the brew process to ensure full flavour and less waste, whether you want a lot of coffee or a little.

When selecting small batch brewing, ensure to only fill the water tank to the 4 cups mark. Refer to the table on page 13 for more information.



## Keep Warm

Once your coffee has finished brewing, the Keep Warm setting keeps it fresh and hot for up to 4 hours. The default warming is set at 2 hours on High temperature. Default warming settings can only be changed while in Ready mode, before brewing.

To change the Keep Warm settings:

1. Press and hold the  button for 3 seconds to change the default warming temperature or time.
2. To change the temperature, press the  button to select **Low**, **Medium** or **High**.

*Note: The current warming temperature can be changed during or after brewing, once the warming plate has turned on.*

3. To change the time, press the  and  buttons and toggle through Hours and Minutes.



*Note: you cannot change the time on the warming plate once warming starts.*

4. Press the  button to confirm choices.

*Once you save your preferences, they are stored as your new default settings for quick and easy brewing next time. You can change settings anytime.*

## Coffee Measurement Chart

We recommend using a medium-fine grind of coffee with your Instant™ Infusion Brew Plus. This will give you optimal results and the smoothest flavour.

Batch Size	Cups	Grounds	Water
Small batch  button is on	4 cups	4 rounded scoops or 6 Tbsp.	4-cup line
Full pot  button is off	6 cups	6 rounded scoops or 9 Tbsp. or 1/2 cup + 1 Tbsp.	6-cup line
	8 cups	8 rounded scoops or 12 Tbsp. or 3/4 cup	8-cup line
	10 cups	10 rounded scoops or 15 Tbsp. or 3/4 cup + 3 Tbsp.	10-cup line
	12 cups	12 rounded scoops or 18 Tbsp. or 1 cup + 2 Tbsp.	12-cup line

## How to brew coffee









### Prep

1. Lift the **water reservoir lid** to open. Remove the **water reservoir** by pulling straight up.
2. Fill the **water reservoir** to desired level. See “Coffee Measurements” for suggested quantities above.

**CAUTION: DO NOT** attempt to brew if the water level is below the MIN fill line.



3. If using coffee beans, grind them down to a medium or medium-fine consistency.

### Brew

1. Lift the **coffee maker lid** and place the **removable brew basket** into the basket holder, making sure it's secure. Insert the **gold-tone coffee filter** (or a #4 cone paper filter) into the **removable brew basket**.
2. Add desired amount of ground coffee into the gold-tone coffee filter. See “Coffee Measurements” table above.
3. Close the **coffee maker lid**. The green  button will turn on. Note: the coffee maker lid must be closed for brewing to start.
4. Choose preferred strength: press the  button for stronger, bolder brew flavour, if desired. The button light will illuminate. Press the  button again to turn off light and brew at classic strength.\*
5. Choose small batch or full pot: Press  if you are brewing fewer than 5 cups. The selected button will illuminate. If you are brewing a full pot leave this off.\*
6. If brewing immediately, press  to keep default settings and brew right away. Or see Step 5 to change your default settings. You can set auto-brew for up to 24 hours ahead of time.
7. Choose brew time: press the  button. Either the default time of 12:00 or the previously set time will flash on the display. Press the  and  buttons to adjust your desired start time.



8. Press the green  button to confirm time.

*To accelerate through the selections, press and hold the  and  buttons.*

*You can cancel brewing and return to Ready mode at any time by pressing the  button.*

9. Every brew has an automatic pre-infusion cycle. Brewing will begin, pause briefly as the coffee grounds are saturated, then continue brewing.
10. When brewing is complete, automatic warming will begin. See “Keep Warm” above.
11. Enjoy your freshly brewed coffee!

*\*Note: Saved settings will activate when you press  button the next time you brew. You can change these at any time.*

#### **WARNING**

To avoid the risk of burn injury and/or property damage DO NOT open the coffee maker lid during or immediately after the brew process. Water may be extremely hot.

Allow contents to cool before opening the lid.

## CARE, CLEANING AND STORAGE

Clean your Instant™ Infusion Brew Plus regularly to ensure the best possible flavour and to prevent mineral deposits from building up in the coffee maker.

Always let parts cool to room temperature before cleaning. Never use metal scouring pads, abrasive powders, or harsh chemical detergents on any of the coffee maker's parts.

Let all parts dry thoroughly before use and before storage.

Instant™ Infusion Brew Plus Part/ Accessory	Cleaning methods and instructions
<ul style="list-style-type: none"><li>Removable water reservoir</li><li>Glass pot</li></ul>	<ul style="list-style-type: none"><li>Remove the reservoir and hand wash with dish soap and warm water.</li><li>Not dishwasher safe.</li></ul>
<ul style="list-style-type: none"><li>Removable brew basket</li><li>Gold-Tone coffee Filter</li></ul>	<ul style="list-style-type: none"><li>Remove and hand wash with dish soap and warm water or place in the top rack of a dishwasher.</li></ul>
Coffee maker / LED panel	<ul style="list-style-type: none"><li>Use a damp dish cloth to clean the outside of the coffee maker and LED panel</li></ul>
Power cord	<ul style="list-style-type: none"><li><b>DO NOT</b> fold power cord when storing.</li></ul>

**CAUTION** To avoid fire, electric shock, personal injury and/or property damage:

- Hand wash only.
- DO NOT** rinse or immerse the coffee maker, power cord, or plug in water or other liquids.

*Any other servicing should be performed by an authorised service representative. For assistance, contact Customer Care at [supportau.instant@instantbrands.com](mailto:supportau.instant@instantbrands.com)*

### Descaling / Removing Mineral Deposits

With regular use minerals may accumulate in the coffee maker, which can affect the temperature and strength of your brew.

To make sure your coffee maker stays in tip top shape, descale it regularly to keep mineral deposits from building up. Your Instant™ Infusion Brew Plus has a built-in cycle for quick and easy cleaning.

After 90 cycles, the ☒ button light will turn on and the ☒ and ☒ button lights will flash to remind you to clean and descale your coffee maker. You will have two options:

### Cancel cleaning

Press the ☒ button to exit reminder mode and return to Ready mode. Your coffee maker will not begin cleaning and the brew cycle counter will reset.

### Start automatic cleaning cycle.

Follow instructions in “How to Descale your Instant™ Coffee Maker Plus” below.

Once the cleaning cycle is completed, the brew cycle counter will reset (counting up to 90) and the device returns to Ready mode.

## How to Descale your Instant™ Infusion Brew Plus

1. Combine cleaner and water as shown in the table “*Descaling Solution Ratio*” below.
2. Fill the **water reservoir** to the **MAX** line with the cleaning mixture.
3. Place the **glass pot** under the **removable brew basket**. Make sure the **coffee maker lid** is closed.
4. Press and hold the ☒ and ☒ buttons for 3 seconds.
5. The ☒ and ☒ buttons will flash slowly and the cleaning mixture will pass through the appliance until the water reservoir is empty.
6. Discard the cleaning mixture from the **glass pot**. Be careful: the mixture will be **HOT**.
7. Return the emptied **glass pot** under the drip nozzle.
8. Remove and rinse the **water reservoir** and fill to the **MAX** line with cool, clean water. Make sure the **coffee maker lid** is closed.
9. Press and hold the ☒ and ☒ buttons for 3 seconds. *The cleaning mixture will pass through the appliance until the water reservoir is empty.*
10. Discard the water from the **glass pot**. The unit is now clean and ready to use again.

## Descaling Solution Ratio

Cleaner	Cleaner to water ratio
Household descaler	1 : 4
Citric acid	3 : 100

## TROUBLESHOOTING

Problem	Cause	Solution
There is sediment/ grounds in my coffee.	<ul style="list-style-type: none"><li>• The grind of coffee may be too fine for the removable filter.</li><li>• You forgot to place a coffee filter into the brew basket before brewing.</li><li>• Using too many grounds can cause the filter holder to overflow.</li></ul>	<ul style="list-style-type: none"><li>• Try using a slightly coarser grind. Finely ground coffee can clog the filter holder. For best brewing results, use a medium-grind coffee</li><li>• Either the permanent filter or a paper filter must be in place when brewing.</li><li>• Once cooled, clean out the filter holder and refill using the appropriate amount of coffee (1 scoop per cup).</li></ul>
Coffee is too weak	<ul style="list-style-type: none"><li>• Classic brew setting was selected.</li><li>• Lighter roast coffee.</li><li>• Not enough ground coffee added.</li></ul>	<ul style="list-style-type: none"><li>• For stronger flavour, try choosing the bold setting [coffee bean button].</li><li>• Use a darker roast.</li><li>• Add additional coffee grounds.</li></ul>
Coffee is too strong	<ul style="list-style-type: none"><li>• Bold brew setting was selected.</li><li>• Coffee roast was too dark.</li></ul>	<ul style="list-style-type: none"><li>• Try Classic brew setting. Press  button to turn off Bold brew.</li><li>• Use a lighter roast.</li><li>• Use fewer grounds.</li></ul>
The pot overflowed during brewing cycle	<ul style="list-style-type: none"><li>• The pot wasn't empty before brewing.</li><li>• Water reservoir was filled above the MAX line</li></ul>	<ul style="list-style-type: none"><li>• Make sure pot is empty.</li><li>• Only add water to the MAX line (1.8L) additional water to the reservoir after a brew or cleaning cycle has already started.</li></ul>

Problem	Cause	Solution
<p>Brew cycle will not start</p> <ul style="list-style-type: none"> <li>NOTE: As part of the pre-infusion process, the brew will start, pause briefly and then continue.</li> </ul>	<ul style="list-style-type: none"> <li>Coffee maker not turned on.</li> <li>Coffee maker lid is not closed.</li> <li>There is no water in the removable water reservoir.</li> <li>The glass pot is not placed on the drip tray correctly.</li> </ul>	<ul style="list-style-type: none"> <li>Ensure the unit is powered on and the display is illuminated. If there are no lights, the machine is not getting power. Try a different outlet.</li> <li>Check to make sure there is water in the water reservoir.</li> <li>Make sure the pot is in place. The brewer will not dispense coffee if the pot is not in place.</li> </ul>
<p>Coffee maker is making unknown or strange sounds and/or buttons are flashing.</p>		<p>Contact Consumer Care at <a href="mailto:supportau.instant@instantbrands.com">supportau.instant@instantbrands.com</a></p>

## LEARN MORE

There's a whole world of Instant™ Infusion Brew information and help just waiting for you. Here are some of the most helpful resources.

### Register your product

[instantbrands.com.au/pages/product-registration](https://instantbrands.com.au/pages/product-registration)

### Contact Consumer Care

[instantbrands.com.au](https://instantbrands.com.au)

[supportau.instant@instantbrands.com.au](mailto:supportau.instant@instantbrands.com.au)

1800 251 643 or +61 2 9317 1000

### Download the Instant Brands Connect App

- Recipes
- New User Tips
- Getting Started Videos



### Join the community



### Product specifications

Model	Volume	Wattage	Power	Weight	Dimensions
DCM-1100	60 oz / 1774 mL water reservoir	1400 W	220- 240V~, 50- 60Hz	6.57 lb 2.98 kg	in: 14.1 H x 6.9 W x 14.4 D cm: 35.9 H x 17.6 W x 36.6 D

# WARRANTY

## Limited Warranty

This Limited Warranty is issued by Instant Brands (Australia) Pty Ltd (Instant Brands Australia) and is effective for one year from the date of original consumer purchase. Proof of original purchase date and return of your appliance is required to obtain service under this Limited. Return of your appliance to us will be done in accordance with our instructions only. Provided that this appliance is operated and maintained in accordance with written operating instructions attached to or furnished with the appliance or published operating instructions on [www.instantbrands.com.au](http://www.instantbrands.com.au), Instant Brands Australia will, in its sole and exclusive discretion, either: (i) repair defects in materials or workmanship; or (ii) replace the appliance. In the event that your appliance is replaced, the Limited Warranty on the replacement appliance will expire 12 months from the date of original consumer purchase.

We remind you the appliance you purchased is for personal use only (not commercial use).

Any modification/alteration or attempted modification/alteration to your appliance will void this Limited Warranty, unless such modification/alteration or attempted modification/alteration was expressly authorised by an Instant Brands Australia Representative in writing.

This Limited Warranty only covers Instant Brands Australia's appliances/products and is not extended to any other appliances, products, equipment, components, or devices that you use or may use in conjunction with the Instant Brands Australia's appliances.

To claim under this Limited Warranty:

1. Contact Instant Brands Australia at:  
Sydney Corporate Park  
Level 1, 182-184 Bourke Road, Alexandria, NSW 2015  
Email: [sales.australia@instantbrands.com](mailto:sales.australia@instantbrands.com)
2. Provide a description of the appliance you believe has malfunctioned due to defective parts or workmanship.
3. If it is necessary for the appliance to be sent to Instant Brands Australia for repair or replacement, Instant Brands Australia will send you a pre-paid shipping label and you must send the appliance and your dated sales receipt to Instant Brands Australia along with the appliance. If you do not have your dated sales receipt, please advise Instant Brands Australia in advance, and Instant Brands Australia will attempt to verify your purchase.
4. If Instant Brands Australia determines that the appliance has malfunctioned due to defective parts or workmanship, and is covered under this Limited Warranty, Instant Brands Australia will repair and return the appliance, or send you a replacement appliance, at Instant Brands Australia's cost.
5. Any repaired or replaced appliance will be covered by this Limited Warranty for the remainder of the original warranty period or ninety (90) days following your receipt of the replacement or repaired appliance, whichever is greater.
6. If Instant Brands Australia confirms the appliance has not malfunctioned due to defective parts or workmanship, and/or is in working order, or if proof of purchase is not verified, Instant Brands Australia reserves the right to return the appliance to you at your pre-paid cost. If this cost is not met, Instant Brands Australia reserves the right to dispose of the appliance after 45 days' notice to you.

# WARRANTY

## Limitation and Exclusions

To the maximum extent permitted by law, the maximum liability of Instant Brands Australia, if any, for any allegedly defective appliance or part shall in no circumstances exceed the purchase price of a comparable replacement appliance or part of the same age.

### *This Limited Warranty does not cover:*

11. Damage resulting from accident, modification/alteration (unless expressly authorised by an Instant Brands Australia Representative in writing), misuse, abuse, neglect, unreasonable use, use contrary to the written operating instructions attached to or furnished with the appliance or published operating instructions on [instantbrands.com.au](http://instantbrands.com.au), normal wear and tear, commercial use, improper assembly by you or anyone, disassembly by you or anyone, repair by you or anyone, failure to provide reasonable and necessary maintenance, force majeure event including but not limited to fire, flood, acts of God;
12. Repairs where your appliance is used for other than normal, personal use or when it is used in a manner that is contrary to the written operating instructions attached to or furnished with the appliance or published operating instructions on [instantbrands.com.au](http://instantbrands.com.au); or
13. Use of unauthorised parts and accessories, or repairs to parts and systems resulting from unauthorised repairs or modifications/alterations made to your appliance.

The cost of repair or replacement under these excluded circumstances shall be borne by you. Our goods come with guarantees that cannot be excluded under the Australian Consumer Law. You are entitled to a replacement or refund for a major failure and compensation for any other reasonably foreseeable loss or damage. You are also entitled to have the goods repaired or replaced if the goods fail to be of acceptable quality and the failure does not amount to a major failure.

Distributed by Instant Brands (Australia) Pty Ltd.  
Sydney Corporate Park  
Level 1, 182-184 Bourke Road, Alexandria, NSW 2015.  
1800 251 643 or +61 2 9317 1000.  
Email: [sales.australia@instantbrands.com](mailto:sales.australia@instantbrands.com)









©2023 Instant Brands (Australia) Pty Ltd.

Sydney Corporate Park  
Level 1, 182-184 Bourke Road, Alexandria  
NSW 2015, Australia.

**[instantbrands.com.au](https://instantbrands.com.au)**

© 2023 Instant Brands LLC.

INSTANT and INSTANT BRANDS are registered  
trademarks of Instant Brands Holdings Inc.