

Instant Pot®

DUO CRISP™ + AIR FRYER

Multi-Use Pressure Cooker & Air Fryer

Welcome

Initial Setup

Product Overview

Getting Started

Venting Methods

Initial Test Run
(Water Test)

Air Frying

More Controls & Smart
Programs

Contact Information



Getting Started Guide



Full Manual, How-to Videos and Recipes available online at instantpot.com.au
Register your product today at instantpot.com.au/support/register

Welcome to the world of Instant cooking.

Thank you for welcoming us into your kitchen.

Having families ourselves, we developed the Instant Pot® Duo Crisp™ + Air Fryer to allow busy families and professionals alike to cook healthy, delicious meals more easily and in less time.

We have partnered with chefs, authors and bloggers to compile a collection of recipes that we hope you enjoy!

Happy cooking,



Robert J. Wang
Founder & Chief Innovation Officer

Download the Instant Pot App

- 1000+ Recipes
- New User Tips
- Getting Started Videos



Initial Setup

- Read all “Important Safeguards” in the included *Safety, Maintenance & Warranty* guide before use. Failure to do so may result in property damage and/or personal injury.
- Use the Duo Crisp pressure cooker lid or the Duo Crisp air fryer lid with the Duo Crisp cooker base. Using any other lids may cause injury and/or damage.
- Remove all packaging material from in and around the appliance and verify that all parts are accounted for.
- Place the cooker base on a stable, level surface, away from external heat sources.
- Follow “Care, Cleaning & Storage” instructions in the included *Safety, Maintenance & Warranty* guide to wash the appliance before cooking.
- Do not remove safety warning stickers from lids, nor the serial number or rating label from the cooker base.



⚠ CAUTION Never use the cooker on a stovetop. Do not place appliance on or in close proximity to a hot gas or electric burner, or a heated oven; heat from an external source will damage appliance. Leave at least 13 cm of space around the Air Fryer Lid, and do not block the air vents. Failure to do so may lead to injury and damage.



Product Overview

Product Overview

Top of Pressure Cooking Lid

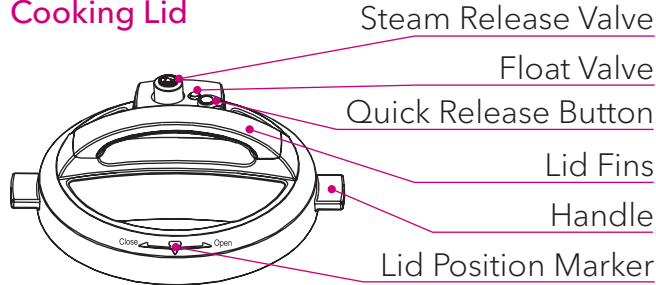

Bottom of Pressure Cooking Lid

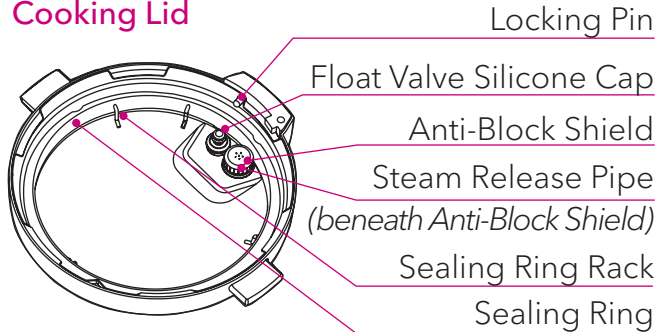

Inner Pot

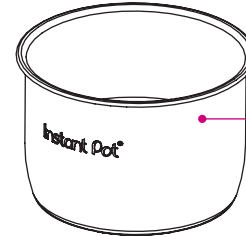

Cooker Base

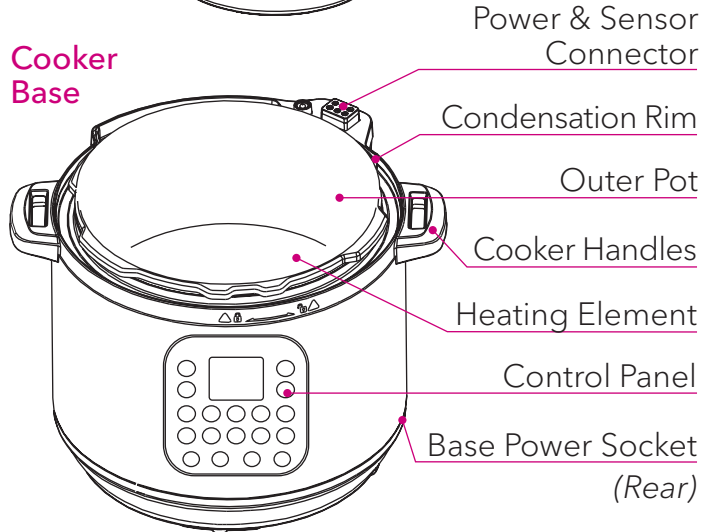

Illustrations in this document are for reference only and may differ from the actual product. Always refer to the actual product. See Safety, Maintenance & Warranty for Care, Cleaning & Storage instructions.

Air Fryer Lid

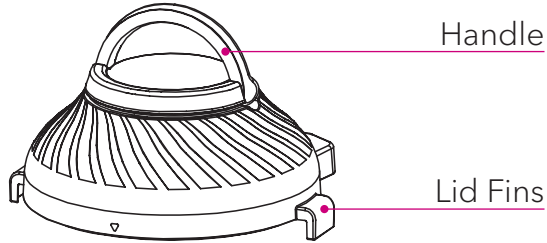

Back

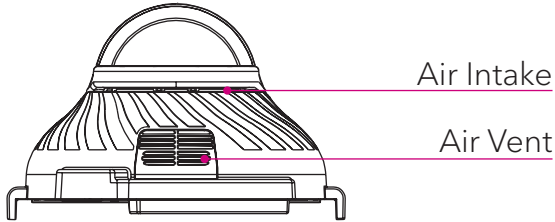

Interior

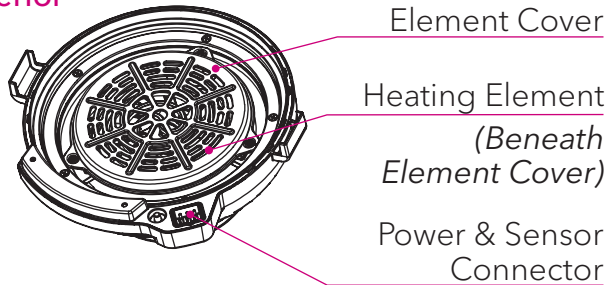

Accessories

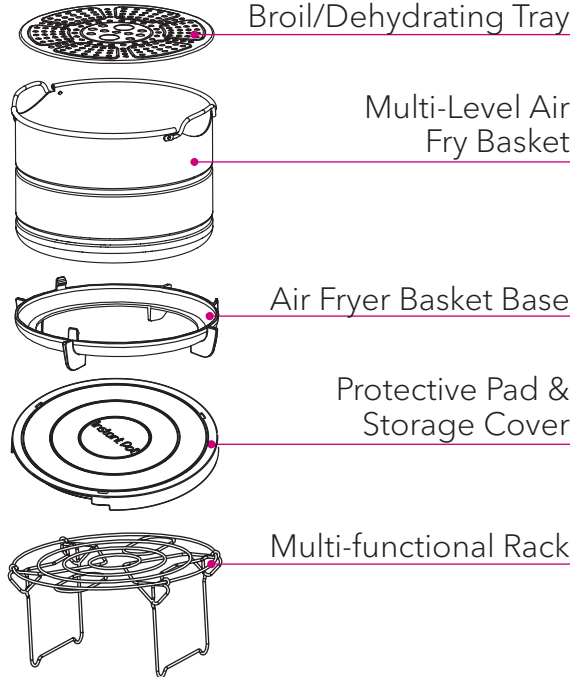

For full instructions on using accessories, view the full manual at instantpot.com.au. Illustrations in this document are for reference only and may differ from the actual product. Always refer to the actual product.

Pressure Cooker Lid

When using the Pressure Cooker Lid, you will only be able to use the Programs associated with that lid, which include Pressure Cook, Sauté, Slow Cook, Steam, Sous Vide, Delay Start & Keep Warm. If you press an Air Fryer Program, "Lid" will appear on the display to indicate that you do not have the correct lid for that program.

You may adjust the time and temperature when using either lid.

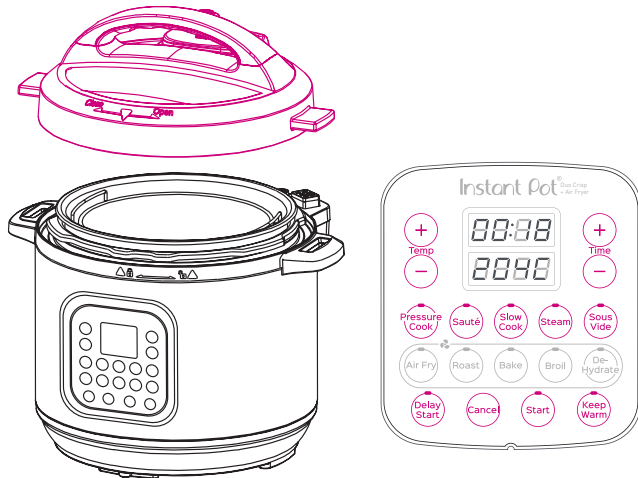

Air Fryer Lid

When using the Air Fryer Lid, you will only be able to use the Programs associated with that lid, which include Air Fry, Roast, Bake, Broil and Dehydrate. If you press a Pressure Cooker Program, "Lid" will appear on the display to indicate you do not have the correct lid for that program.

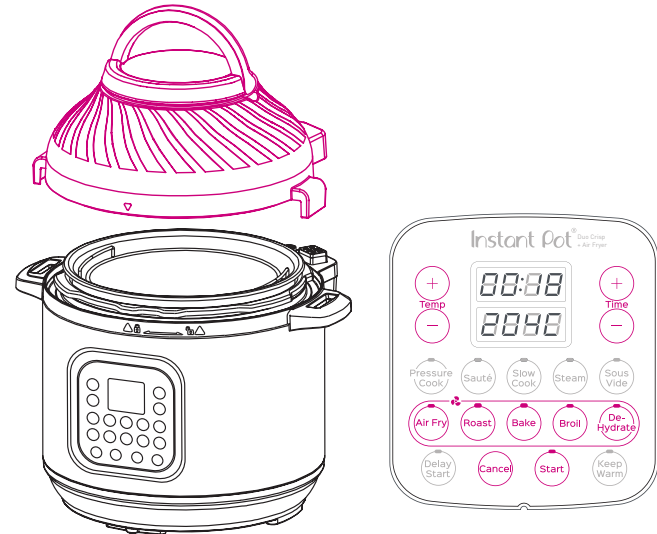

A top-down view of a pressure cooker on a grey surface. A hand is pouring white milk from a silver can into the pot. The pot contains a red soup with yellow lentils, orange vegetable slices, and white onions. The text "Pressure Cooking" is overlaid in white. To the left, three small white bowls contain red sauce, red paste, and yellow powder.

Pressure Cooking

Using the Pressure Cooking Lid

1

Open and Close the Pressure Cooking Lid

When the cooker is plugged in, it plays a jingle when lid is (opened and) closed properly.

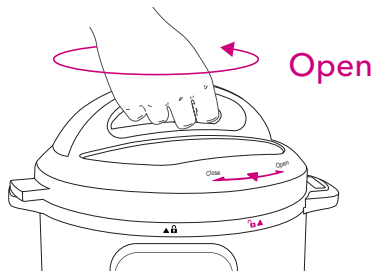

Open: Grip handle and turn lid anti-clockwise until ▼ on lid is aligned with ◀▶ indicator on the rim of cooker base. Lift lid up and off cooker base.

Note: Always check the pressure cooking lid for damage prior to cooking.

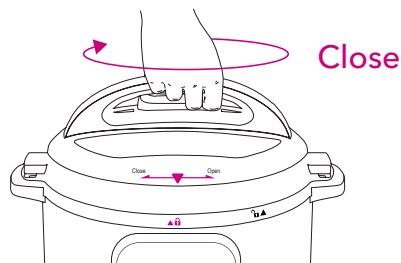

Close: Grip handle and align the ▼ on lid with ◀▶ indicator on rim of cooker base. Lower lid into track then turn lid clockwise until ▼ on the lid lines up with ◀▶ indicator on cooker base.

Note: The cooker will not operate without the lid properly in place. Ensure the lid is fully closed before attempting to operate the cooker.

⚠ WARNING

While float valve is **up**, contents of cooker are pressurised. **Do not attempt to remove lid.**

Refer to “Venting Methods” section in this guide for information on releasing pressure.

Failure to comply with this instruction could cause injuries or property damage.

See *Safety, Maintenance & Warranty for Care, Cleaning & Storage instructions.*

2

Check the Sealing Ring & Sealing Ring Rack

Remove: Pull sealing ring out from behind sealing ring rack.

Inspect sealing ring rack. It should be centred in the lid and an even height all the way around.

Sealing ring must be installed before use.

See Safety, Maintenance & Warranty for Care, Cleaning & Storage instructions.

To check or clean the following parts in Steps 2-7, please make sure unit is unplugged and cool before performing any of these tasks.

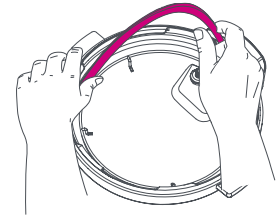

Remove

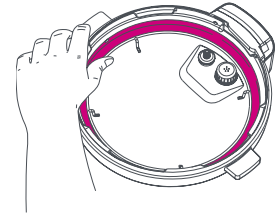

Install

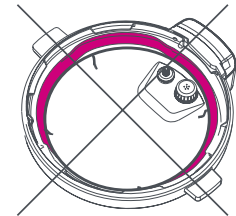

Incorrect

CAUTION

Always check for cuts or deformations in sealing ring prior to cooking. Only use authorised Instant Pot® sealing rings. Sealing rings may stretch over time. Do not use a stretched or damaged sealing ring. If stretching occurs, replace sealing ring. Failure to follow these instructions may cause food to discharge, which may lead to personal injury or property damage.

See Safety, Maintenance & Warranty for Care, Cleaning & Storage instructions.

3

Remove & Install Float Valve

The float valve has 2 positions. It **pops up** to indicate when the cooker is pressurised and **lowers into the lid** when the cooker is **depressurised**.

Remove: Place one finger on the flat **top** of the float valve. Turn lid over. Detach silicone cap from the **bottom** side of the float valve. Remove float valve from **top** of lid. Do not discard float valve or silicone cap.

The float valve and silicone cap must be installed before use to seal in pressurised steam.

Install: Drop float valve into float valve hole on **top** of lid. Place one finger on the flat top of float valve. Turn lid over. Attach silicone cap to **bottom** of float valve. Refer to “Venting Methods” in this guide for information on releasing pressure.

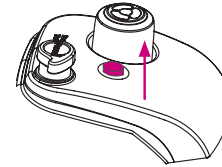

Pressurised

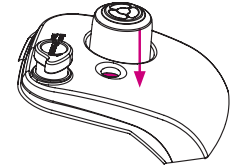

Depressurised

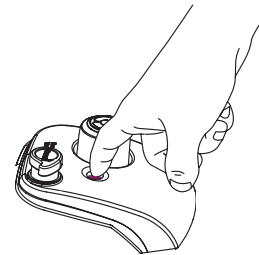

Top

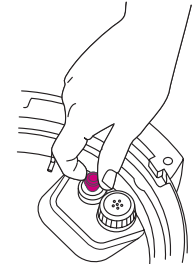

Bottom

⚠ WARNING

While float valve is **up**, contents of cooker are pressurised. **Do not attempt to remove lid.** Refer to “Venting Methods” section in this guide for information on releasing pressure. Failure to comply with this instruction could cause injuries or property damage.

See Safety, Maintenance & Warranty for Care, Cleaning & Storage instructions.

4

Remove & Install Anti-Block Shield

Remove: Grip lid and press firmly against side of anti-block shield (pressing towards side of lid and up) until it pops off the prongs underneath.

Anti-block shield must be installed before use and cleaned frequently.

Install: Place anti-block shield over prongs and press down until it snaps into position.

Anti-block shield prevents food particles from coming up through the steam release pipe, assisting with pressure regulation.

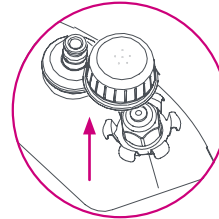
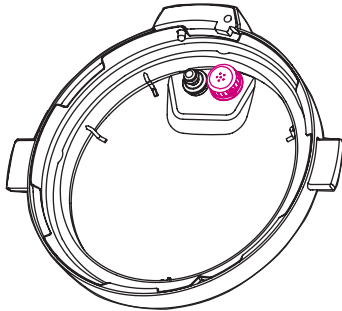

Remove

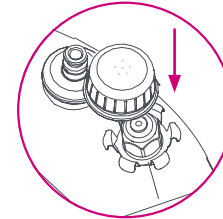

Install

See Safety, Maintenance & Warranty for Care, Cleaning & Storage instructions.

5

Remove & Install Steam Release Valve

Remove: Pull steam release valve up and off steam release pipe.

Steam release valve must be installed before use and cleaned frequently.

Install: Place steam release valve on steam release pipe and press down. Fits loosely when installed properly, but remains in place when the lid is turned over.

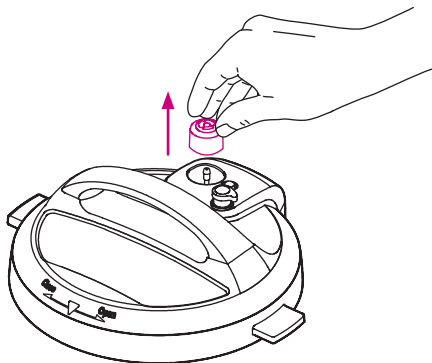

Remove

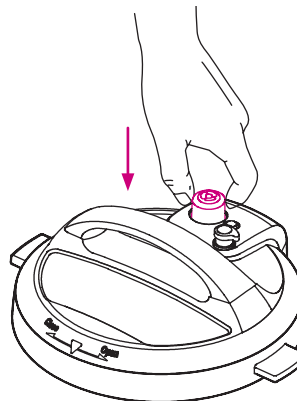

Install

CAUTION

If release valve is not installed, water will spatter out of the steam release pipe which may lead to burns and injury.

See *Safety, Maintenance & Warranty for Care, Cleaning & Storage instructions.*

6

Remove & Clean Inner Pot

Remove inner pot from cooker base and wash with hot water and washing up liquid before first use.

Clean the outer surface of inner pot and the heating element located on the inner surface of the outer pot with a clean dry cloth to ensure it is dry and free of food debris. Failure to do so may damage the cooker.

Place inner pot into cooker base before cooking. Food must be placed only in the inner pot, not cooker base.

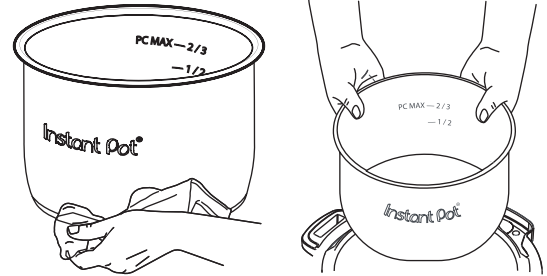

Note: Always check the inner pot for dents or deformations prior to cooking. If inner pot is dented or deformed, stop using the cooker. Visit [instantpot.com.au](https://www.instantpot.com.au)

CAUTION

The inner pot is an integral part of product safety. Always use an authorised stainless steel Instant Pot® inner pot made for this model when cooking. Failure to do so may cause personal injury or property damage. To avoid risk of personal injury and/or property damage, do not pour food or liquid into cooker base.

WARNING

Do not fill the inner pot higher than the **PC MAX — 2/3 line** (Pressure Cooking Maximum), as indicated on the inner pot. Exercise extreme caution when cooking and venting food such as stewed apples, cranberries, pearl barley, oatmeal, split peas, noodles, etc., as these foods may foam, froth or spatter, and may clog the steam release pipe and/or steam release valve. Do not fill the inner pot higher than the **— 1/2 line** when cooking these foods. Failure to do so may cause personal injury or property damage.

See *Safety, Maintenance & Warranty for Care, Cleaning & Storage instructions.*

7

Install Condensation Collector

Install: On back of cooker base, align grooves on condensation collector over tabs and push condensation collector into place.

The condensation collector accumulates excess water and should be installed before cooking. Must be emptied and rinsed after use. Failure to install will result in water dripping on to your countertop.

Remove: Pull condensation collector away from cooker base. Do not pull down on condensation collector.

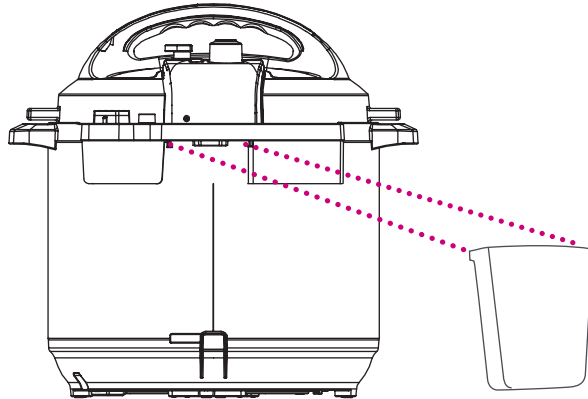

See Safety, Maintenance & Warranty for Care, Cleaning & Storage instructions.

Venting Methods

Venting Methods

When closing the lid, the quick release button will automatically reset to the popped up “Seal” position.



Seal



Vent

Natural Release (NR)

Leave the steam release in the “**Seal**” position (up). The cooker dissipates heat so pressure releases naturally over time.

This method must be used when cooking food such as soups, stews or chilis, as well as food that expands, such as beans and grains.

Note: *Depressurisation time varies based upon volume of food and liquid. May take 10-40 minutes, or longer.*

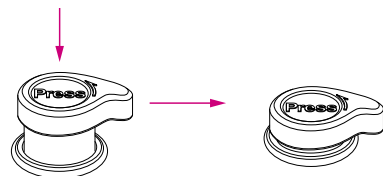

Quick Release (QR)

Vent: Press quick release button down until it clicks.

When depressed, a continuous stream of steam is released through the steam release valve until the float valve drops into the lid.

Note: *It will be loud!*

If spatter occurs, turn quick release button to reset it to the “**Seal**” position, and try again after a few minutes. If spatter continues, use NR to vent remaining pressure.

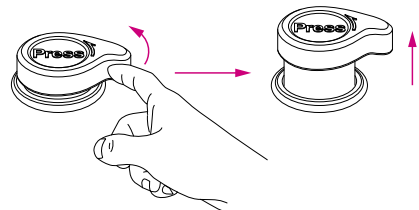

⚠ WARNING

Do not lean over the steam release valve.

Do not place unprotected skin over the steam release assembly.

Do not cover the steam release valve.

The float valve drops when the cooker has depressurised. Do not attempt to open the lid while the float valve is still popped up.

Failure to follow these instructions may lead to injury or damage.

Initial Test Run

Complete this test to familiarise yourself with pressure cooking in the Duo Crisp. Approximate time: 20 minutes.

1. Add 3 cups (~750 mL) water to inner pot.
2. Insert inner pot into cooker base.
3. Connect the appropriate power lead for your outlet type to the cooker base, then insert the plug into an accessible outlet.

Display indicates "OFF".

4. Align ▼ on lid with ▲ on cooker base.
Lower lid into track, then turn lid clockwise to align ▼ with ▲ until jingle sounds.

Steam release automatically resets to "Seal" position when the lid is closed.

5. Select Smart Program: **Pressure Cook**.

6. Use + / - keys to adjust cook time to "00:05" minutes.

Note: The Instant Pot® saves customisations made to cook time.

7. Press "Start", the display indicates "On" and cooker begins Preheating.



For details on Smart Programs and operation instructions, refer to the full User Manual at instantpot.com.au

8. Float valve rises when cooker has pressurised.
Once pressurised, **Cooking** begins and display changes from "On" to cook time countdown.
9. When the Smart Program is completed, cooker begins **Keep Warm** or display indicates "End".
10. Press quick release button down until it clicks into "Vent" position.
Pressurised steam releases through top of steam release valve.
Float valve drops when pressure has been fully released.
11. To open, grip handle and turn lid anti-clockwise until ▼ on lid is aligned with ▲ indicator on the rim of cooker base. Lift lid up and off cooker base.
12. Discard water and dry inner pot.
13. Start cooking!

⚠ CAUTION

Steam is hot! Avoid exposure to skin. Failure to follow this instruction may result in burn injury.

For details on Smart Programs and operation instructions, refer to the full User Manual at instantpot.com.au



Air Frying

Air Frying



Pressure Cook Your Food First

After completing the initial test run, follow the instructions for your favourite pressure cooker recipes at [instantpot.com.au](https://www.instantpot.com.au) or download our recipe app.

After all pressure has been released, remove the pressure cooker lid and follow the air frying instructions on page 23 starting with Step 1.

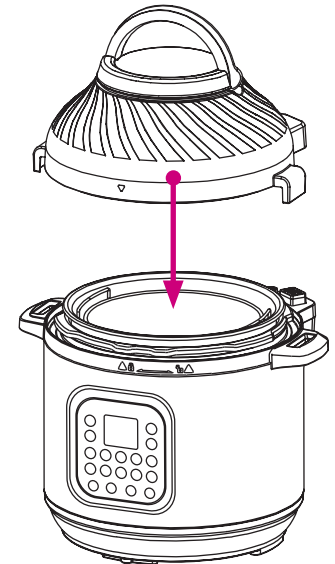
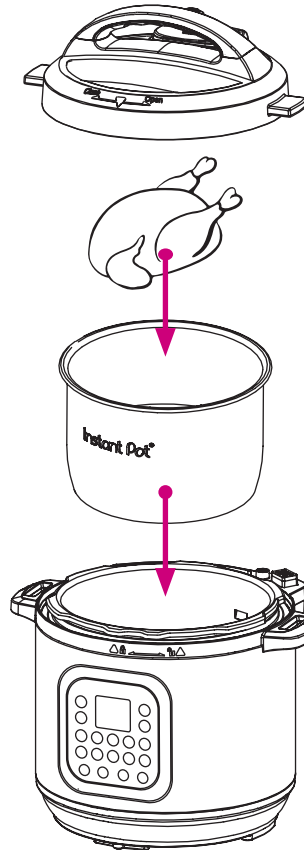

B

Air Fry Only

STEP 1: If not pressure cooking first, insert the stainless steel inner pot into the Instant Pot® cooker base.

Insert the air fry basket with the basket base or oven-safe cookware into the inner pot.

STEP 2: Add your food into the air fryer basket. Follow instructions on page 23.

Note: All oven-safe cookware is safe to use in the inner pot. The provided air fry basket features multiple levels to suit your cooking needs. Refer to the full User Manual on [instantpot.com.au](https://www.instantpot.com.au) for detailed cooking instructions. For best results, use the air fryer basket.

STEP 1

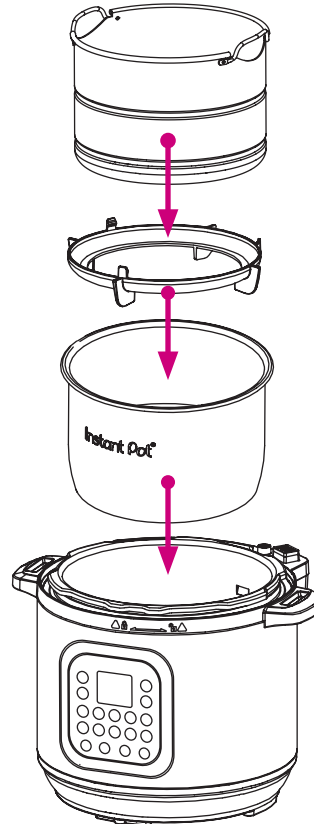

STEP 2

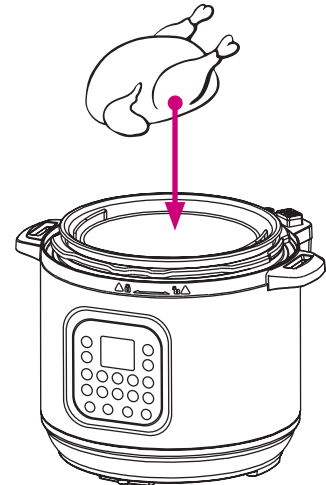

1

Place the Air Fryer Lid on the cooker base by lining up the lid fins and inserting them into the base handles.

Press Air Fryer Lid down to ensure the power and sensor parts are fully connected to each other.

A jingle sounds when the lid is placed properly and the display indicates "OFF".

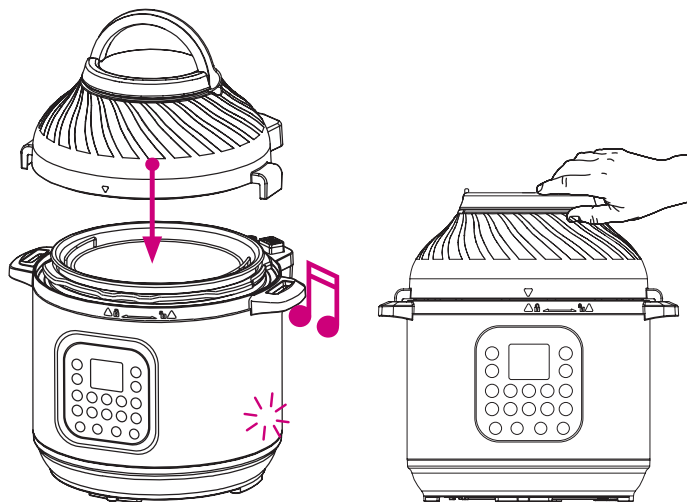

2

Select a Smart Program:

Air Fry, Broil, Bake, Roast or Dehydrate.

For details on Smart Programs and operation instructions, refer to the full User Manual at instantpot.com.au



WARNING If the power and sensor parts are not fully connected, you may get a Lid message or C9 error. Failure to ensure they are properly connected could result in damage to the cooker.

3

Use the + / – keys to adjust the **Time** and **Temperature**.

Note: The cooker saves customisations made to the cook time or temperature.

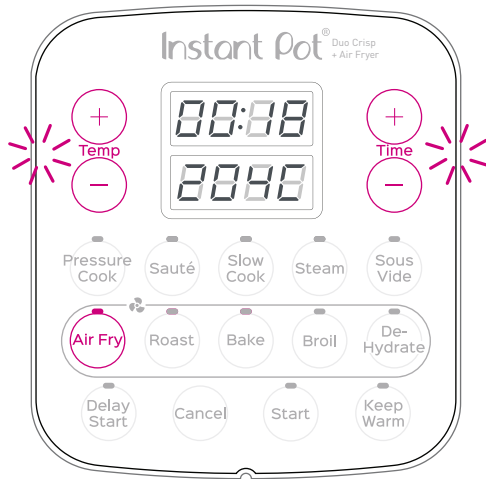

4

Press **Start**.

The display indicates "On" as the Air Fryer Lid **preheats**. After preheating, the display will change to the set time and start to count down.

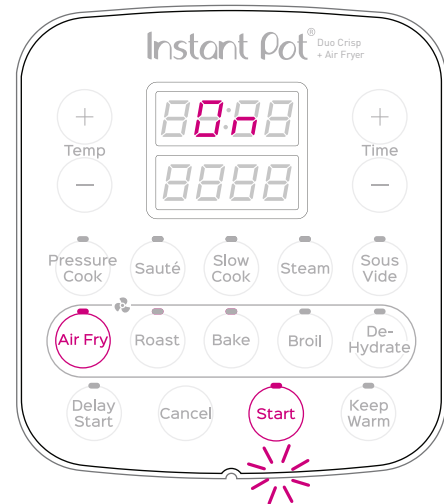

5

For **Air Fry** and **Roast** Smart Programs only, the cooker beeps part-way through the cooking cycle and the display indicates “**turn Food**”.

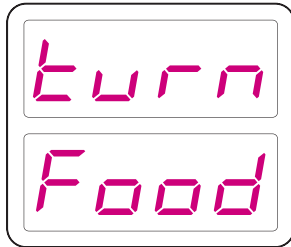

6

Lift the Air Fryer Lid off the Instant Pot® cooker base and place it on the protective pad provided.

Lifting the lid automatically pauses cooking.

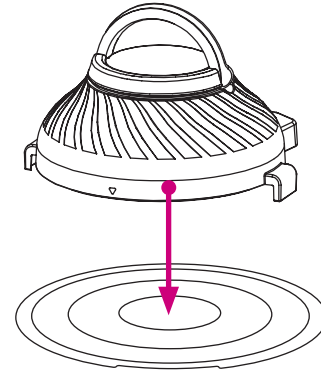

CAUTION

To avoid personal injury or damage to property, only place the lid on the protective pad provided.

7

Use oven mitts and/or accessories to turn, flip, or rotate your food, then press Air Fryer Lid down to ensure the power and sensor parts are fully connected to each other.

Note: Some food does not require turning. If the lid is not removed after the “turn food” indicator appears, cooking will proceed after 10 seconds.

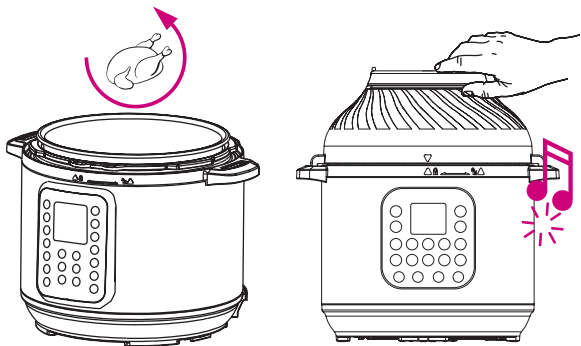

CAUTION Appliance and contents will be hot. Failure to follow this instruction may result in burn injury.

8

The display will count down in seconds when there is one minute of cooking time remaining.

When the Smart Program completes, the lid beeps and the display indicates “End”.

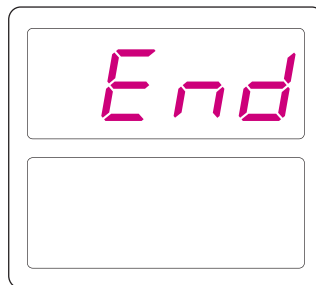

WARNING If the power and sensor parts are not fully connected, you may get a Lid message or C9 error. Failure to ensure they are properly connected could result in damage to the cooker.

9

Lift the Air Fryer Lid off the Instant Pot® cooker base and place it on the protective pad.

Note: The Air Fryer Lid will beep to remind you that cooking has ended 5 minutes, 20 minutes, and 60 minutes after cooking has completed.

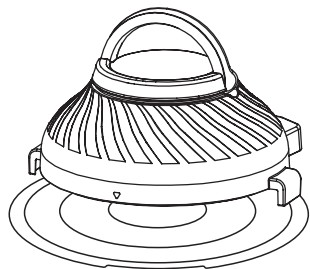

CAUTION

The inner accessories will be hot during and after cooking. To avoid injury, use oven mitts and do not touch the inner pot accessories with bare skin.

10

To store your Air Fryer Lid, wipe clean with a damp cloth once it is fully cooled. Flip the Protective Pad over so the grooved side is uppermost and attach it to the Air Fryer Lid.

For further operation instructions, refer to the full User Manual online at [instantpot.com.au](https://www.instantpot.com.au)

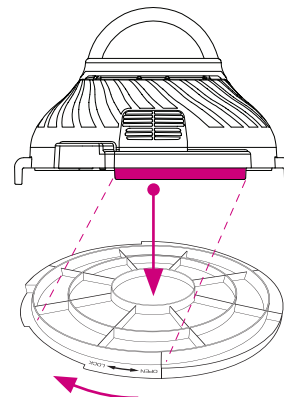

A top-down view of a white oval plate filled with golden-brown french fries. To the left of the plate are two glass dipping bowls. The larger bowl contains red ketchup, and the smaller bowl contains a light-colored, creamy sauce. The text "More Controls" is overlaid in white on the fries.

More Controls

More Controls

Cancel	Press to stop a Smart Program at any time. Display returns to Standby and indicates "OFF".
Delay Start (Pressure Cooking Lid Only)	Postpone cooking up to 24 hours. Select a Smart Program and if desired, adjust the cooking time and temperature, then press Delay Start to turn the setting on. Use the + / - keys to adjust the time of delay before cooking begins.
Keep Warm	Setting is on by default on Pressure Cook, Slow Cook & Steam Smart Programs. Once a Smart Program is selected, press Keep Warm to turn the setting off.
Reset to Factory Settings	When in Standby "OFF", press and hold Cancel until the cooker beeps. All Smart Programs are reset to default settings.
Smart Program Reset	When in Standby "OFF", press and hold the individual Smart Program until the cooker beeps. The desired Smart Program is reset to default settings.
Sound On/Off	When in Standby "OFF", press and hold + above Time until the display indicates "S On" (Sound On) or "S OFF" (Sound Off). Note: Error alerts cannot be silenced.
Temp. Display °C/°F	When in Standby "OFF", press and hold + above Temp until the display indicates "C" or "F". The unit indicated is the current selection.

A close-up photograph of a white bowl filled with thick-cut, purple potato chips. The chips are golden-brown with a vibrant purple hue. The text "Smart Programs" is overlaid in the center in a white, sans-serif font. In the bottom right corner, a small portion of another white bowl containing pink salt is visible.

Smart Programs

Smart Programs Using Pressure Cooking Lid

Smart Program	Default Time hh:mm	Time Range hh:mm	Default Temperature / Pressure	Temperature Range	Auto Keep Warm	Notes
Pressure Cook	00:35	00:00 - 04:00	Hi (High) 9.4-12.3 psi (65-85 kPa)	Lo (Low) 5.1-8.0 psi (35-55 kPa) Hi (High) 9.4-12.3 psi (65-85 kPa)	Yes	Use pressure cooking lid. Ensure quick release button is set to "Seal" position.
Sauté	00:30	00:01 - 00:30	Hi (High)	Lo (Low) Hi (High)	No	Do not use a lid when using Sauté. When display switches from "On" to "Hot" , add recipe ingredients. If ingredients are added before "Hot" message appears, it may not appear at all.
Slow Cook	06:00	00:30 - 24:00	Lo (Low)	Lo (Low) Hi (High)	Yes	Use pressure cooking lid. Works like a traditional slow cooker. Ensure quick release button is set to "Vent" position.

Smart Program	Default Time hh:mm	Time Range hh:mm	Default Temperature / Pressure	Temperature Range	Auto Keep Warm	Notes
Steam	00:30	00:00 – 04:00	Hi (High) 9.4-12.3 psi (65-85 kPa)	Lo (Low) 5.1-8.0 psi (35-55 kPa) Hi (High) 9.4-12.3 psi (65-85 kPa)	Yes	Use pressure cooking lid or a regular glass lid. Use a steam rack to elevate food from cooking liquid. Use Quick Release to prevent food from overcooking.
Sous Vide	03:00	00:30 – 99:30	56°C	21 – 93°C	No	Use pressure cooking lid. Salt lightly and use garlic powder rather than raw garlic or garlic salt. If your dish is not going to be consumed immediately, plunge pouches into ice water to reduce temperature quickly, then keep refrigerated.
Keep Warm	10:00	00:10 – 24:00	Hi (High)	Lo (Low) Hi (High)	No	

Pressure cooking Smart Programs operate at **High** (9.4-12.3 psi) or **Low** (5.1-8.0 psi) pressure. Higher pressure results in higher temperature.

Smart Programs Using Air Fryer Lid

Smart Program	Level	Time Range hh:mm	Default Time hh:mm	Default Temp or Pressure	Temperature Range	Auto Keep Warm	Notes
Air Fry	N/A	00:01 - 01:00	00:18	204°C	82°C-204°C	No	Air Fryer Lid.
Roast	N/A	00:01 - 01:00	00:40	193°C	82°C-204°C	No	Air Fryer Lid.
Bake	N/A	00:01 - 01:00	00:30	185°C	82°C-204°C	No	Air Fryer Lid. Pour cake batter into springform pan and cover for baking.
Broil	N/A	00:01 - 00:40	00:08	204°C	N/A	No	Air Fryer Lid. Assemble air fry basket and place food on broil/ dehydrating tray.

Smart Program	Level	Time Range hh:mm	Default Time hh:mm	Default Temp or Pressure	Temperature Range	Auto Keep Warm	Notes
Dehydrate	N/A	01:00 - 72:00	07:00	52°C	41°C-74°C	No	Air Fryer Lid. Assemble air fry basket and place food beneath the broil/dehydrating tray.

Visit instantpot.com.au for full User Manual and operation instructions.



Enjoy time well spent with
the Instant family of small appliances.

Instant Pot®

Register your product today at:

instantpot.com.au/support/register

©2020 Corelle Brands (Australia) Pty Ltd.

Distributed by Corelle Brands (Australia) Pty Ltd.

9c Commercial Road, Kingsgrove, NSW, 2208, Australia

Ph 1800 251 643 or 02 9317 1000

support@instantpot.com.au

instantpot.com.au