



RACK/HUB®

INSTRUCTIONS.

CAUTION
SHARP OBJECTS INSIDE

RH2

RH1

Please follow these instructions. Your antlers will thank you.

1 Secure your antler with the pedicle (base) facing in an upright position. (We recommend wrapping something soft around the antler and placing it in a vise).

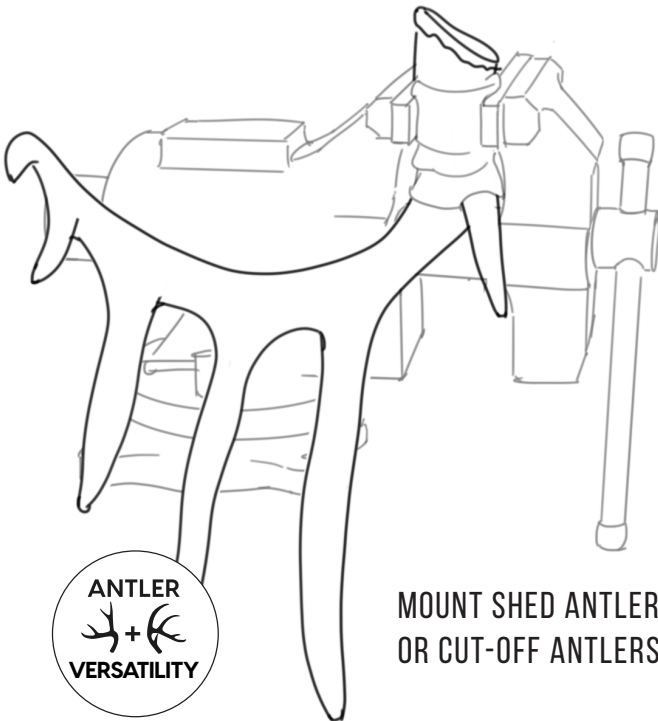

MOUNT SHED ANTLERS OR CUT-OFF ANTLERS.

PACKAGE INCLUDES.

- Fully assembled **RH1** or **RH2**
- 3/32" Hex Wrench
- 5/16" Drill Bit
- #9 - 1 1/2" Black mounting screws (x2)
- **ANTLER INSERT(s)** [(x1) for RH1 / (x2) for RH2]
- (Antlers not included)



TOOLS NEEDED OR RECOMMENDED.

- Power drill
- Phillips driver
- Rubber mallet
- Safety glasses
- Vise
- Towel (something soft to wrap antlers while drilling)
- **Saw or grinder for exceptionally rough pedicles

Failure to use the recommended products and procedures could result in improper installation or cause serious injury.

2 Before drilling, mark your drill bit with a 1" marking (2A - shown below). Using the provided 5/16" drill bit, drill a hole starting at the center of the pedicle using the beam as an angle reference. The hole should be 1" in depth. Line up the beam from a few angles prior to drilling (do this to avoid drilling completely through the antler).



2A MARK THE DRILL BIT AT 1"

We recommend using tape, paint, or a marker to stripe the drill bit at 1" from the tip.

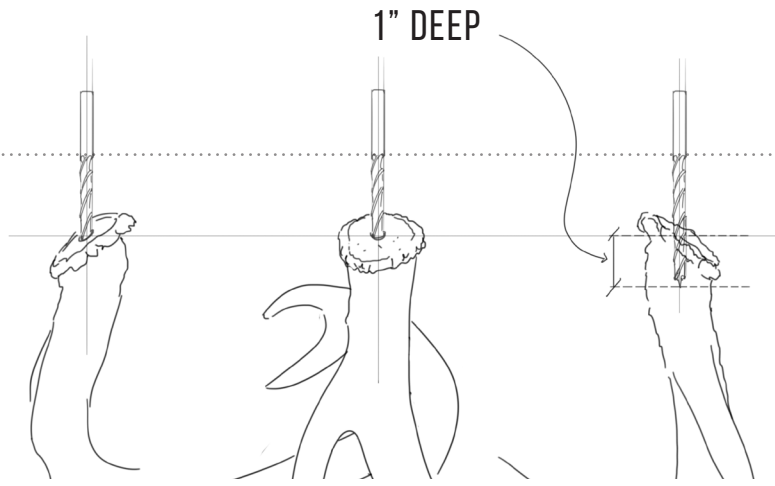
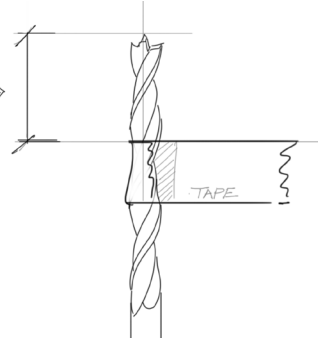

An improperly drilled hole may result in the need to add an adhesive to the antler insert.

3 Starting with the small end, place the **ANTLER INSERT** into the drilled hole. Press the insert in until it's snug, and then find a rubber mallet. Using the mallet, gently tap the insert into the antler until the top lip of the insert touches the antler base.

ANTLER INSERT

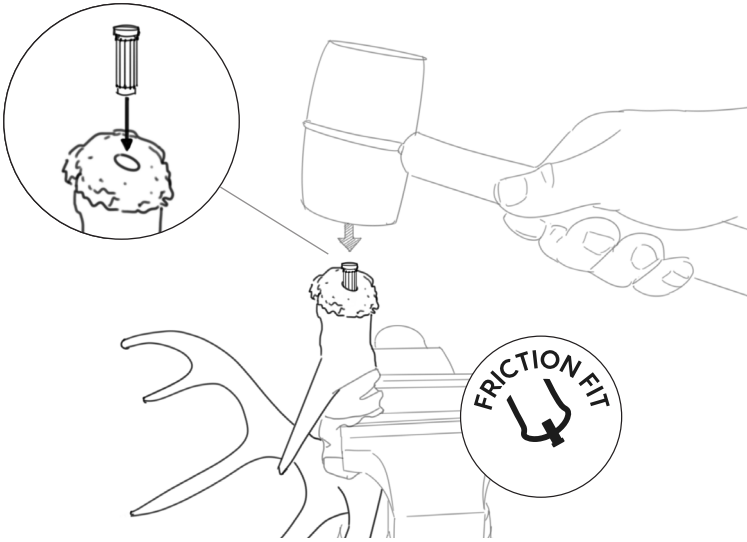

5 Slide the antler onto the hex stem (attached to the ball) aligning the stem with the **ANTLER INSERT** (mating hex features). Slide the antler down until it's fully engaged on the **BALL/STEM**. Now you can rotate the antler 360 degrees to choose your desired orientation. Once you have it in perfect position, turn the **KNURLED CAP** clockwise to tighten the ball in place.

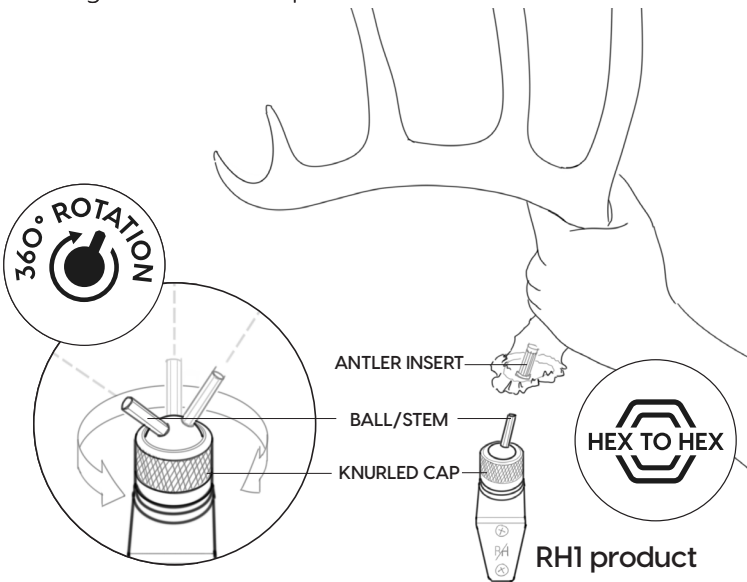

4 Find a solid surface to mount your bracket. Using the two screws provided, fasten the bracket to the surface with a phillips driver. We recommend a 3/32" bit for pre-drilling. (If you're installing it to drywall, be sure to fasten the product to a stud for a secure mount).

The RH1 and RH2 bracket mounting pattern is provided below.

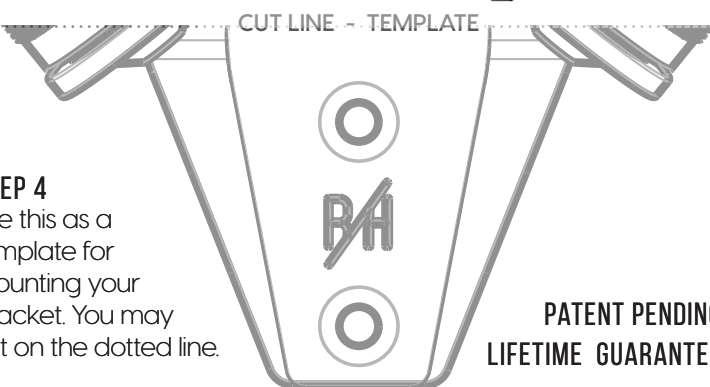
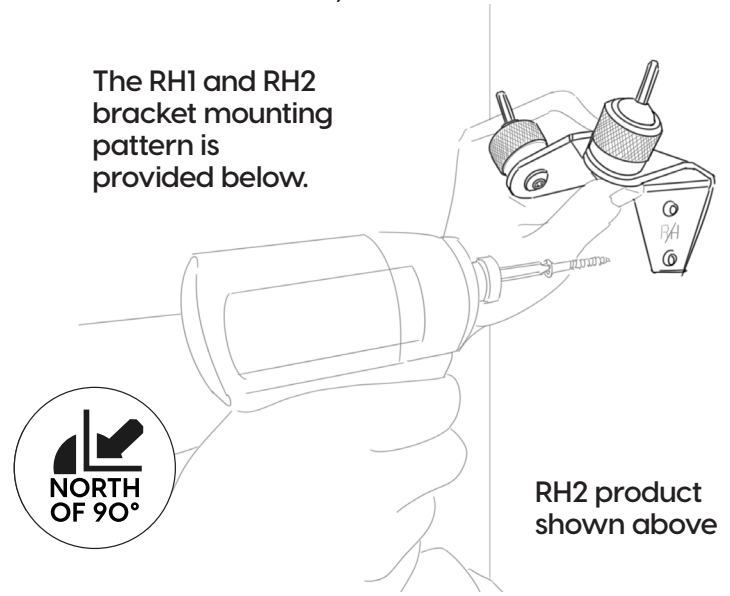

6 For added strength and security, use the provided 3/32" hex wrench to tighten the set screw located on the bottom side of the bracket. This screw will lock the ball joint assembly in your desired position. Note: this set screw is only required for heavy antlers, it's not always necessary.



You have now successfully installed your RACK HUB® product. Remember, your antlers can be removed at any time, and we highly encourage that interaction.

Visit our website for more information or to see our online installation video.

THANK YOU!

WWW.RACK-HUB.COM

Keep in touch, and follow us on our social media platforms. We would love to hear your feedback and see how our products are being used. We strive for quality, and we can only do that with your help. Please use #RackHub when sharing your photos.

