

PRIMA

STANDARD SIZES & FINISHES

■ NATURALE ● SOFT ▲ AEXTRA20

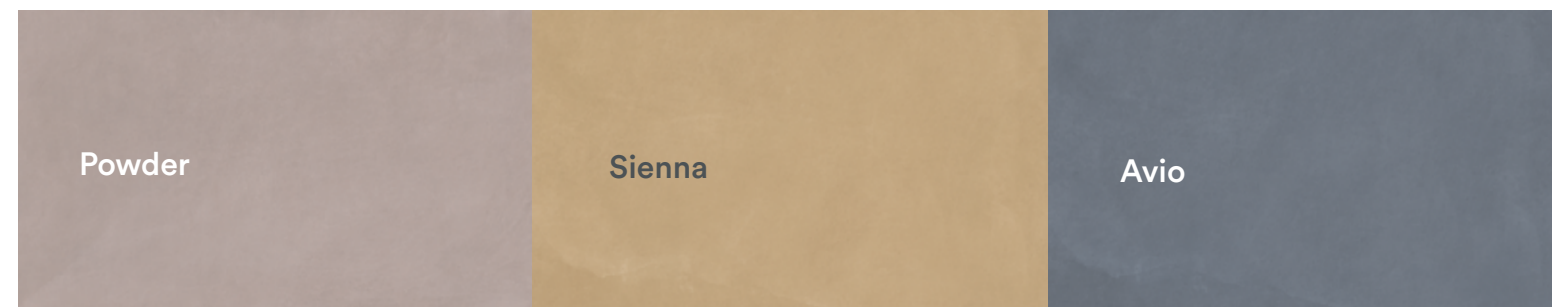

PRIMA

MOSAIC SIZES & FINISHES

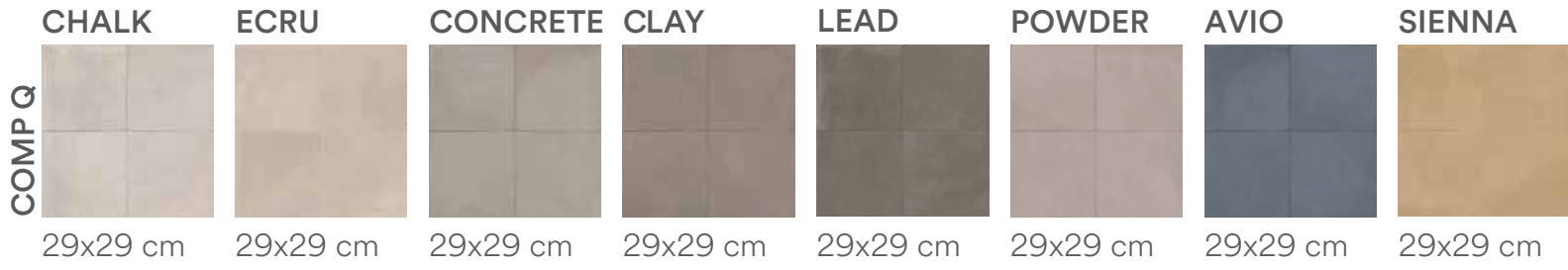

MATT RT R10 B

SOFT RT

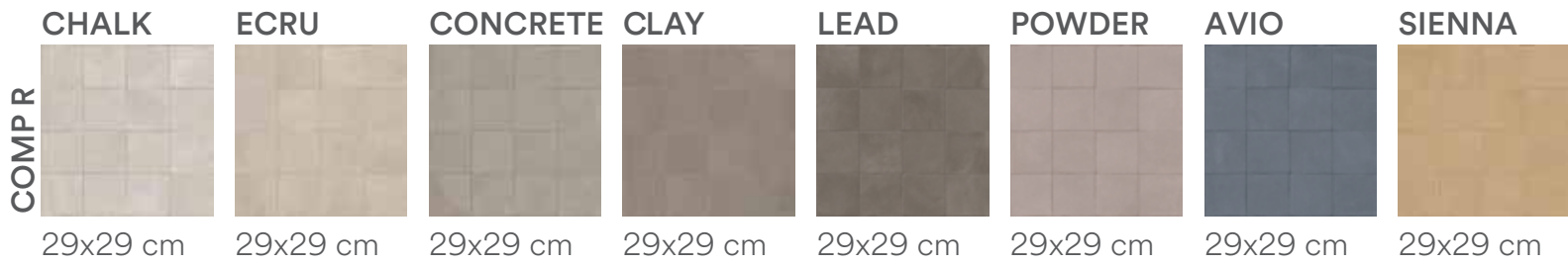

MATT RT R10 B

SOFT RT

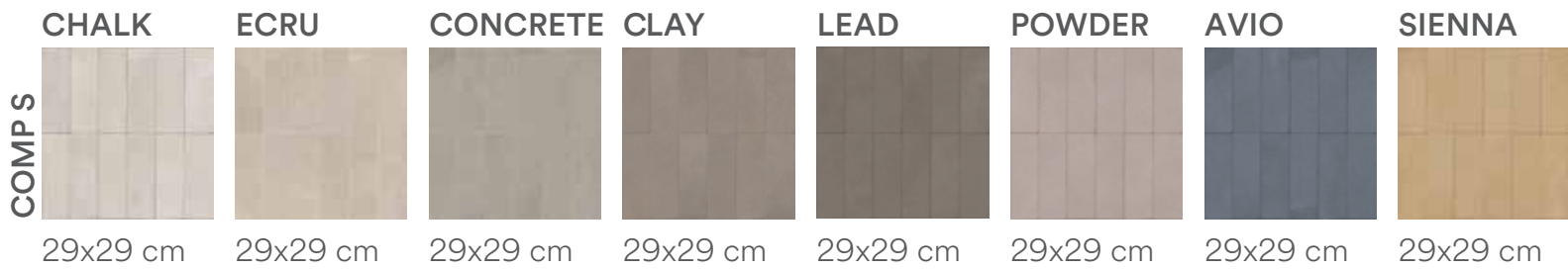

SOFT RT

BELOW: ECRU



145x145mm TILES ON MESH



72.5x72.5mm TILES ON MESH



48x145mm TILES ON MESH

PRIMA

MOSAIC SIZES & FINISHES

The cut mosaics Comp Q, Comp R and Comp S are distinguished by a striking irregular edge that recalls the typical imperfections of craftsmanship.

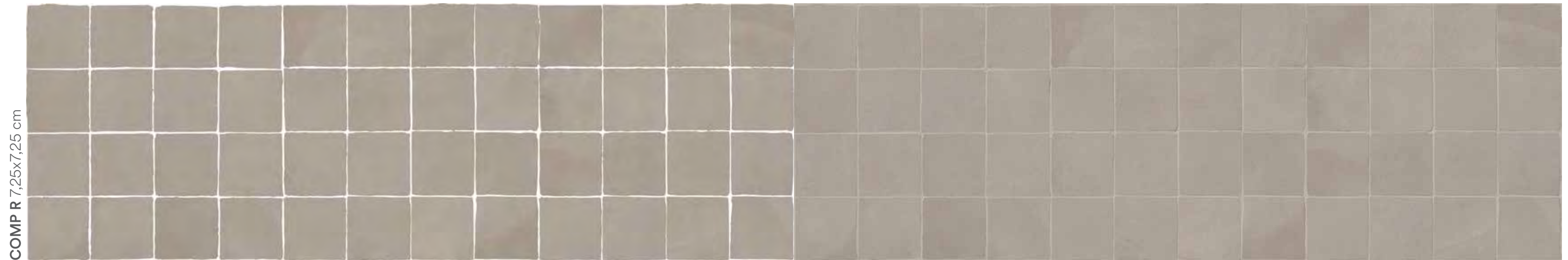
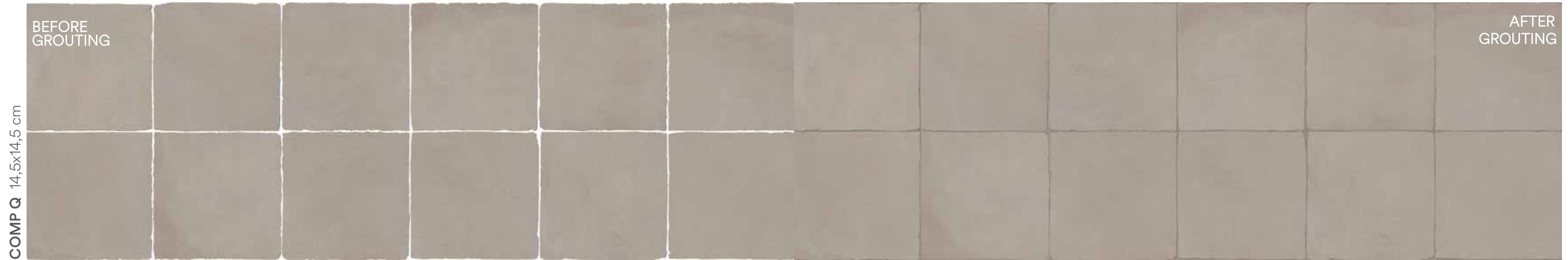

PRIMA

DECOR SIZES & FINISHES

The Rammed decoration uses the handicraft technique of rammed earth, popular in hot climates, with which clay is layered to achieve a sinuous visual effect.

RAMMED
120x278 cm
R9

↓
6mm
↑



Alternating between opacity and reflectivity, the Impression decoration evokes an impression of ferns and shrubs on clay, creating fascinating flowery textures with a rocky effect.

IMPRESSION
120x278 cm
R9

Made on Prima - Ecreu.

↓
6mm
↑



PRIMA

DECOR SIZES & FINISHES

The Gold Willow decoration, available in slab size 120x278, is appreciated for a precious flowery design with golden reflections, applied on a Concrete background. The Gold Willow 120x278 decorations are produced by third-firing application of gold-based inks.

GOLD WILLOW
120x278 cm
R9

↓
6mm
↑



GOLD WILLOW 120x278 cm



IMPRESSION 120x278 cm

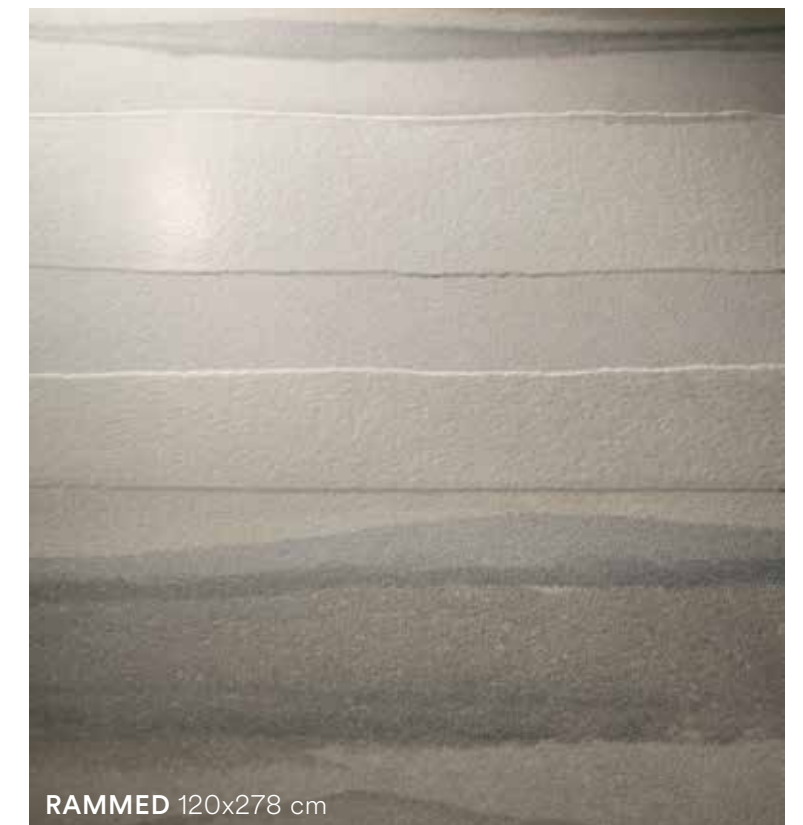

RAMMED 120x278 cm

PRIMA

20mm THICK PAVERS



ECRU v2



80x80 cm

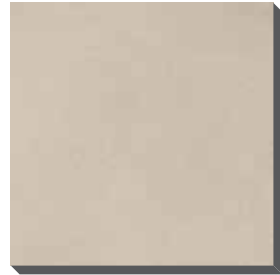

60x60 cm

CONCRETE v2

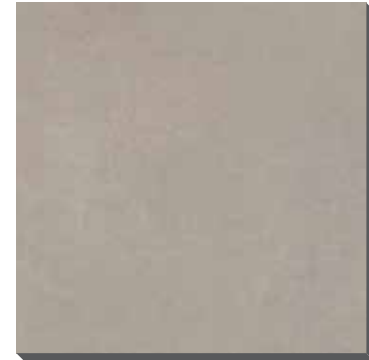

80x80 cm



60x60 cm







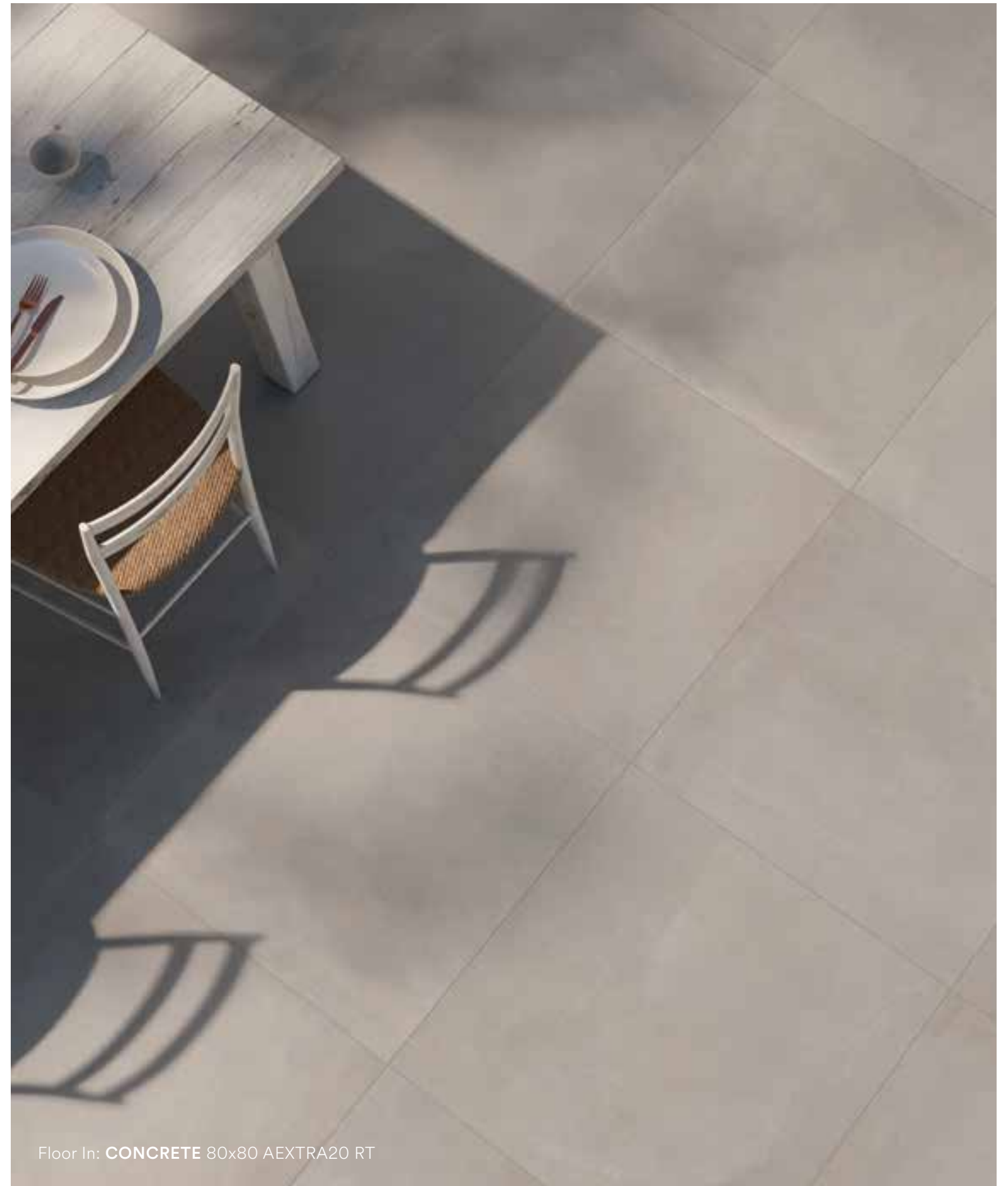

For further details on the 20 mm products and the installation systems, in particular for recommendations, restrictions of use, and precautions during installation, please refer to www.caesar.it website and to the Aextra 20 catalogue.

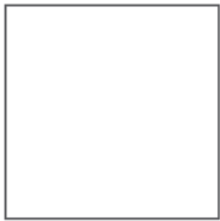

Floor Out: **ECRU** 80x80 AEXTRA20 RT, **ECRU** XSOLID 30x80 AEXTRA20 RT,
Floor In: **ECRU** 120x120 SOFT RT
Wall: **POWDER COMP S** 29x29 SOFT RT, **CHALK** 60x120 SOFT RT



Floor In: **CONCRETE** 80x80 AEXTRA20 RT



									
	120x278 cm	120x120 cm	60x120 cm	60x120 cm	80x80 cm	60x60 cm	30x60 cm	80x80 cm	60x60 cm
	6 mm MATT RT R9	9 mm SOFT RT	9 mm SOFT RT	9 mm MATT RT R10 B	9 mm MATT RT R10 B	9 mm MATT RT R10 B	9 mm MATT RT R10 B	20 mm RT R11 C	20 mm RT R11 C
Chalk		●	●	●	●	●	●		
Ecrú		●	●	●	●	●	●	●	●
Concrete	●	●	●	●	●	●	●	●	●
Clay		●	●	●	●	●	●		
Lead		●	●	●	●	●	●		
Powder			●						
Avio			●						
Sienna			●						

RT Rectified, squared, one caliber.

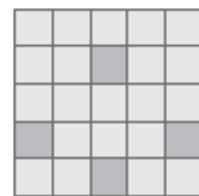
V2



Minimum variation. Visible variations but similar shades.

			
	Bullnose	Step tread	Step tread corner
	7,2x60 cm	33x120 cm	33x33 cm
	MATT RT R10 B	MATT RT R10 B	MATT RT R10 B
Chalk	●	●	●
Ecrú	●	●	●
Concrete	●	●	●
Clay	●	●	●
Lead	●	●	●