

# 承 认 书

## Specification for Approval

Customer		Customer Model	
Trantek Model	巨人之心 RGB 版	Trantek Part No.	HX4D-TBBS0B-1019AC

### Approved by TRANTEK

Approved by	Checked by	Prepared by

### Approved by Customer

Research & Development	Quality Assurance

Remark:

1 This product specification considered as the technical agreement between the receiving customer and Trantek. Any information on the general Product Catalogue which is in conflict with or different from the corresponding information of this document is considered as invalid.

2 If customer issue purchase orders without confirmation by signature of this specification after receipt. Such confirmation will be considered as granted upon receipt of the first purchase order.

正牌签署（盖章）  
Sign for Trantek Approved  
送承认日期：\_\_\_\_\_.

客户签署（盖章）  
Sign for Customer Approved  
确认日期：\_\_\_\_\_.

Reference No.: \_\_\_\_\_



<b>TRANTEK ELECTRONICS CO., LTD.</b>		文件编号 FILE NO.	HX4D-TBBS0B-1019AC	页码 PAGE	3/9
		发布日期 DATE OF ISSUE	2022年09月10日		
PRODUCT SPECIFICATION 产品承认书		文件版次 EDITION	第A版 第0次修订		
SERIES 系列	巨人之心 RGB 版	产品编码 PART NO.	HX4D-TBBS0B-1019AC		

<p><b>1. General Characteristics 一般特性:</b></p> <p>1.1 Application: This specification is applied to the keyboard switch for general applications. 适用范围: 该承认书指键盘开关的一般使用范围。</p> <p>1.2 Operating Temperature Range: -25°C to +70°C 使用温度范围: -25°C to +70°C</p> <p>1.3 Operating Relative Humidity: ≤85% RH 相对湿度: ≤85%RH</p> <p>1.4 Test Conditions: Unless otherwise specified, the atmospheric conditions for making measurements and tests are as follows: 实验条件: 若没有特别说明, 则试验大气条件如下:</p> <p>Environment Temperature: 5~35°C 环境温度: 5~35°C</p> <p>Relative Humidity: 45~85% 相对湿度: 45~85%</p> <p>Atmospheric Pressure: 86~106Kpa (860~1060mbar) 大气压力: 86~106Kpa (860~1060mbar)</p>			
<p><b>2. Appearance, Structure and Dimensions 外观, 结构及尺寸:</b></p> <p>2.1 Appearance: The switch shall have qualified, and no rusts, cracks or plating defects. 外观: 产品外观合格, 无锈蚀、裂纹和镀层缺陷。</p> <p>2.2 Structure &amp; Dimensions: Refer to individual product drawing. 结构及尺寸: 参见产品图纸</p> <p>2.3 Markings: Refer to individual product drawing. 标识: 参见产品图纸。</p>			
<b>3. Ratings 额定负荷</b>		12V DC Max. 2V DC Min. 10mA DC Max. 10μA DC Min.	
<b>4. Initial electrical Characteristics 初始的电气性能</b>			
No.	Item 项目	Criteria 标准	Test Method 实验方法
4.1	Contact Resistance 接触电阻	200mΩ Max.	Any equipment with error not more than 5% can be used. Resistance after test is the average of 5 successive measurements. (To measure after operated 5 to 10 times) 用误差不超过5%的仪表进行测量, 实验后的电阻取5次测量的平均值。(按动5-10次后测量)
4.2	Insulation Resistance 绝缘电阻	100MΩ Min.	100VDC voltage is applied between each pair of terminals and between the terminal and the metal frame for 60±5S. 在相互绝缘的所有端子之间及各接线端子与外露的非载流金属零件之间加载100V直流电, 持续时间60±5S。
4.3	Dielectric Voltage 抗电强度	No dielectric breakdown shall occur. 无击穿现象发生。	100VAC (50~60Hz, cut-off current 2mA) is applied between non-connected terminals and between terminals and the metal frame for 60±5s. 在相互绝缘的所有接线端子之间及各接线端子与外壳或非载流金属零件之间加载100V (50-60Hz) 截止电流2mA交流电, 持续时间60±5S。

<b>TRANTEK ELECTRONICS CO., LTD.</b>		文件编号 FILE NO.	HX4D-TBBS0B-1019AC	页码 PAGE	4/9
		发布日期 DATE OF ISSUE	2022年09月10日		
PRODUCT SPECIFICATION 产品承认书		文件版次 EDITION	第A版 第0次修订		
SERIES 系列	巨人之心 RGB 版	产品编码 PART NO.	HX4D-TBBS0B-1019AC		

5. Initial mechanical Characteristics 初始的机械特性					
No.	Item 项目	Criteria 标准	Test Method 实验方法		
5.1	Operating Force 操作力	42±10gf	<p>Apply a tension meter on the midpoint of the actuator (or tip of the shaft) to supply a pressure vertically from its free position to operating position.            在操作元件末端沿操作方向均匀施加静载荷,使操作元件转换到动作位置。</p>		
5.2	Pre travel 行程	1.2+0.6/-0.2mm	<p>The distance vertically through, which is the trip move from its free position to "on" position.            从自由位置到导通位置的距离。</p>		
5.3	Total Travel 总行程	3.6±0.3mm	<p>The distance vertically through, which is the trip move from its free position to bottom position.            开关按钮从自由位置移动到底部位置之间的距离。</p>		
5.4	Bounce 抖动	ON bounce: 5ms max. OFF bounce: 5ms max.  ON 的抖动: 5ms 以下 OFF 的抖动: 5ms 以下。	<p>(1)Lightly striking the center of the stem at a rate encountered in normal use (2 to 3 operations per sec.) bounce shall be tested at "ON" and "OFF".            在正常使用中以 2-3 次/秒的速度轻轻按压按钮中心部位,在"ON"和"OFF"两种状态都应测试抖动。</p> <p>(2)OFF area: The area which the voltage is 2.5V or more.            OFF 状态: 出力电压 2.5 伏以上。</p> <p>(3)ON area: The area which the voltage is 2.5V or less.            ON 状态: 出力电压 2.5 伏以下。</p> <p>(4)T1,T2≤5ms</p>		

<b>TRANTEK ELECTRONICS CO., LTD.</b>		文件编号 FILE NO.	HX4D-TBBS0B-1019AC	页码 PAGE	5/9
		发布日期 DATE OF ISSUE	2022年09月10日		
PRODUCT SPECIFICATION 产品承认书		文件版次 EDITION	第A版 第0次修订		
SERIES 系列	巨人之心 RGB 版	产品编码 PART NO.	HX4D-TBBS0B-1019AC		

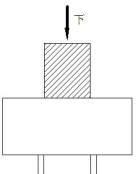
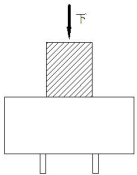
6. Durability characteristics 机械耐久性能					
No.	Item 项目	Criteria 标准	Test Method 实验方法		
6.1	Terminal Strength 端子强度	After test, Electrically and mechanically performances shall be satisfied. 试验后: 电气和机械性能无异常。	A static load of 0.5N shall be applied to the tip of terminals for 10 ± 1s in any direction. 任意方向施加 0.5N 作用力于接线端末端, 持续时间 10 ± 1s.		
6.2	Push strength 按压强度	After test, Electrically and mechanically performances shall be satisfied. 试验后: 电气和机械性能无异常。	Along side plunger effect 50N force on plunger top lasting for 15s 沿着按柄轴心方向施加 50N 作用力于按柄顶端, 持续时间 15S		
6.3	Pull strength 推压强度	100N min (10kgf min)	Along side plunger effect force on plunger top to reach the breaking strength 沿着按柄轴心方向施加作用力于按柄顶端, 达到破坏的强度.		
6.4	Button Tensile Strength 按钮的抗拉强度	After test, Electrically and mechanically performances shall be satisfied. 试验后: 电气和机械性能无异常。	A static load of 2.5Kg shall be applied to the tip of button in an opposite direction to Operating Force and be kept for 30±1s. 以操作力相反的方向对按钮施加 2.5Kg 静负荷, 并持续 30 ± 1s.		
6.5	Vibration Proof 振动	After test, Electrically and mechanically performances shall be satisfied. 试验后: 电气和机械性能无异常。	Switch shall be secured to a testing machine by a normal mounting device and method. Switch shall be measured after following test. (1) Vibration frequency range = 10~55 Hz (2) Total amplitude = 1.5mm (3) Sweep ratio: 10~55~10Hz Approx. 1 min (4) Method of changing the sweep vibration frequency: linear (5) Direction of vibration: Three perpendicular directions including actuating direction. (6) Duration: 2 hours (6 hours in total) 开关采用常规的安装方法牢固地安装在试验设备上, 并在下述参数条件下进行试验: (1) 振频=10-55Hz (2) 振幅 1.5mm (3) 振动变化速率: 10-55-10Hz 大约 1 分钟 (4) 变频方法: 线性型式 (5) 振动方向: 三个相互垂直的方向, 其中一个方向应是促动元件运动的方向。 (6) 时间: 每个方向 2 小时 (共 6 小时)。		

<b>TRANTEK ELECTRONICS CO., LTD.</b>		文件编号 FILE NO.	HX4D-TBBS0B-1019AC	页码 PAGE	6/9
		发布日期 DATE OF ISSUE	2022年09月10日		
PRODUCT SPECIFICATION 产品承认书		文件版次 EDITION	第A版 第0次修订		
SERIES 系列	巨人之心 RGB 版	产品编码 PART NO.	HX4D-TBBS0B-1019AC		

No.	Item 项目	Criteria 标准	Test Method 实验方法
6.6	Mechanical Shock 冲击	After test, Electrically and mechanically performances shall be satisfied. 试验后: 电气和机械性能无异常。	Switch shall be measured after following test: (1) Mounting Method: Normal (2) Acceleration: 490m/s <sup>2</sup> (50G) (3) Duration: 11ms (4) Test Direction: 6 directions (5) Number of shocks: 3 times per direction (18 times in total) 试件在下述参数条件下进行试验: (1) 安装方法: 常规方法 (2) 加速度: 490m/s <sup>2</sup> (50G) (3) 时间: 11ms (4) 实验方向: 图示6方向 (5) 冲击次数: 每个方向3次(总共18次)
6.7	Life 寿命	After test, Contact resistance: 5Ω Max. Insulation resistance: 10MΩ Min. Bounce :10 ms max Tolerance of operating force Disintegration shall be within 30% of specified value Electrically and mechanically performances shall be satisfied. 实验后: 接触电阻: 5Ω Max. 绝缘电阻: 10MΩ Min. 抖动: 10 毫秒以下 操作力衰变应在±30%以内。 其它电气和机械性能无异常。	100,000,000 cycles of operation shall be performed continuously at a rate of 300~360 cycles per minute without load. 在不带负荷的条件下, 速度为300~360次/分, 在寿命试验设备上连续转换100,000,000次。

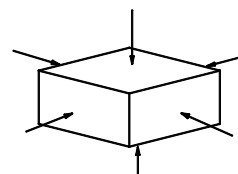

### 7. Soldering Characteristics 焊接性能:

No.	Item 项目	Criteria 标准	Test Method 实验方法
7.1	Solder Ability 可焊性	More than 90% of immersed part shall be covered with solder. 超过90%的浸锡面积被焊料所覆盖。	The terminations shall be tested according to the following request: (1) Solder: Sn-3.0 Ag-0.5 Cu tin/lead-free. (2) Flux: Rosin Flux having a nominal composition of 25% solids by mass of water white rosin in methyl alcohol solution. (3) Solder temperature: 260±5°C. (4) Immersion time: 3seconds. 开关在下述参数条件下进行试验: (1) 焊料: Sn-3.0 Ag-0.5 Cu /无铅锡 (2) 焊剂: 焊剂, 质量百分比为25%松香, 75%甲醇的无色透明溶液。 (3) 焊接温度: 260±5°C (4) 浸渍时间: 3s

<b>TRANTEK ELECTRONICS CO., LTD.</b>		文件编号 FILE NO.	HX4D-TBBS0B-1019AC	页码 PAGE	7/9
		发布日期 DATE OF ISSUE	2022年09月10日		
PRODUCT SPECIFICATION 产品承认书		文件版次 EDITION	第A版 第0次修订		
SERIES 系列	巨人之心 RGB 版	产品编码 PART NO.	HX4D-TBBS0B-1019AC		

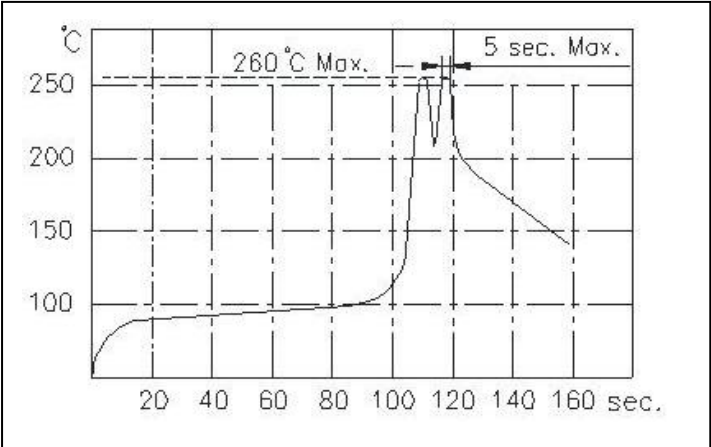
No.	Item 项目	Criteria 标准	Test Method 实验方法
7.2	Resistance To Soldering Heat 耐焊接热	After test, Electrically and mechanically performances shall be satisfied. 试验后： 电气和机械性能无异常。	<p>Switch shall be tested according to the following request:</p> <p>(1) Soldering Temperature &amp; Immersing Time(tin/lead-free): Wave soldering: 260°C Max 5s Max Manual soldering: 350°C Max 2-3s</p> <p>(2) Solder: Sn-3.0 Ag-0.5 Cu tin/lead-free.</p> <p>(3) Flux: Rosin Flux having a nominal composition of 25% solids by mass of water white rosin in methyl alcohol solution.</p> <p>(4) rate of immersion and emergence: 25(±6)mm(1.00±0.25in.), per second</p> <p>(5) Immersion Depth: The required depth of immersion is to within 1~1.5mm of the device body.</p> <p>(6) The product should go through wave soldering for 1 times based on the following test condition.</p> <p>试件按下述试验条件进行试验：</p> <p>(1)无铅焊接温度及时间： 波峰焊：260°C Max, 5s Max.; 烙铁焊：350°C Max 2-3s</p> <p>(2)焊料：Sn-3.0 Ag-0.5 Cu /无铅锡</p> <p>(3)焊剂：焊剂，质量百分比为25%松香，75%甲醇的无色透明溶液。</p> <p>(4)浸渍速度：25(±6) mm (1.00±0.25in.)每秒</p> <p>(5)浸渍深度：在安装基准面的1~1.5mm以内</p> <p>(6)试件按下述实验条件过一次波峰焊。</p> 

<b>TRANTEK ELECTRONICS CO., LTD.</b>		文件编号 FILE NO.	HX4D-TBBS0B-1019AC	页码 PAGE	8/9
		发布日期 DATE OF ISSUE	2022 年 09 月 10 日		
PRODUCT SPECIFICATION 产品承认书		文件版次 EDITION	第 A 版 第 0 次修订		
SERIES 系列	巨人之心 RGB 版	产品编码 PART NO.	HX4D-TBBS0B-1019AC		

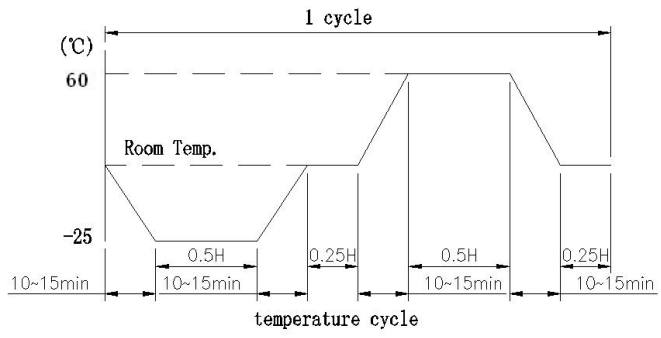
8. Weather Proof Characteristics 耐候性能:					
No.	Item 项目	Criteria 标准	Test Method 实验方法		
8.1	Low temperature test 低温	After test, Electrically and mechanically performances shall be satisfied. 试验后: 电气和机械性能无异常。	The Switch shall be stored at a temperature of $-25 \pm 2^{\circ}\text{C}$ for 48 hours in a thermostatic chamber,. And then the encoder shall be subjected to standard atmospheric condition for 1 hour after which measurements shall be made 试件在 $-25\pm 2^{\circ}\text{C}$ 的温控箱内保持 48 小时, 然后在正常温度和湿度下恢复 1 小时, 并在此后 1 小时内对试样进行测量。		
8.2	High temperature test 高温		The Switch shall be stored at a temperature of $60 \pm 2^{\circ}\text{C}$ for 48 hours in a thermostatic chamber,. And then the encoder shall be subjected to standard atmospheric condition for 1 hour after which measurements shall be made. 试件在 $60\pm 2^{\circ}\text{C}$ 的温控箱内保持 48 小时, 然后在正常温度和湿度下恢复 1 小时, 并在此后 1 小时内对试样进行测量。		
8.3	Steady state damp heat test 恒定湿热		The Switch shall be stored at a temperature of $60\pm 2^{\circ}\text{C}$ with relative humidity of 90% to 95% for 96 hours in a thermostatic chamber,. And then the encoder shall be subjected to standard atmospheric condition for 1 hour after which measurements shall be made. 试件在 $60\pm 2^{\circ}\text{C}$ , 90-95%RH 的温控箱内保持 96 小时, 然后在正常温度和湿度下恢复 1 小时, 并在此后 1 小时内对试样进行测量。		
8.4	Temperature Cycling 温度转换	After test, Electrically and mechanically performances shall be satisfied. 试验后: 电气和机械性能无异常。	After 5 cycles of following conditions, the Switch shall be allowed to stand under normal temperature and humidity conditions for 1 hour, and measurement shall be made within 1 hour after that. Water drops shall be eliminated. 试件按下述实验条件试验 5 次, 然后在正常温度和湿度下恢复 1 小时, 并在此后 1 小时内对试样进行测量。 		
8.5	Salt Mist 盐雾实验	After test, Electrically and mechanically performances shall be satisfied. 试验后: 电气和机械性能无异常。	The switch shall be done spraying experiment based on the following test condition. (1) Temperature: $35 \pm 2^{\circ}\text{C}$ (2) Salt Solution: $5 \pm 1\%$ (Solids by mass) (3) Duration: 24hour (4) After test, salt deposit shall be cleaned by water. 试件在下述实验条件下做喷雾试验: (1) 温度: $35 \pm 2^{\circ}\text{C}$ (2) 盐溶液浓度: $5 \pm 1\%$ (质量百分比) (3) 时间: 24 小时 (4) 实验后的盐沉积物用水冲掉。		



<b>TRANTEK ELECTRONICS CO., LTD.</b>		文件编号 FILE NO.	HX4D-TBBS0B-1019AC	页码 PAGE	9/9
		发布日期 DATE OF ISSUE	2022年09月10日		
PRODUCT SPECIFICATION 产品承认书		文件版次 EDITION	第A版 第0次修订		
SERIES 系列	巨人之心 RGB 版	产品编码 PART NO.	HX4D-TBBS0B-1019AC		

<b>9. Packaging 包装:</b>	
Packaging spec. SHX4D-TBBS0B-1019AC 包装详细规格见 SHX4D-TBBS0B-1019AC 包装规范。	
<b>10. Precautions for use 注意事项:</b>	
<p>10.1 In order to protect the switch performance and the soldering conditions, it should keep the switch under the following conditions:为防止本产品的性能劣化和耐焊性等性能受到影响,请保管在以下的条件和环境下:</p> <p>10.1.1. Temperature of -25°C to +70°C, with humidity lower than 85%RH; 温度 -25°C 以上, +70°C 以下, 湿度85% 以下的环境。</p> <p>10.1.2. Avoid storing in the environment containing corrosive gas; 避免保存在含有腐蚀性气体等的空气中。</p> <p>10.1.3. Avoid keeping it in the location with direct sunlight. 避免保存在日光能直射的场所。</p> <p>10.1.4. Store using the standard packing without exerting force. 在不施加负重外力的包装状态下进行保管。</p> <p>10.2 Product have certain dustproof effect,but do not have waterproof function and can not functioning dustproof completely. 产品不具备完全防尘和防水功能。</p> <p>10.3 The standard storage period is 6 months before opening the package. Preferably to be used as soon as possible. After opening the package, you should put the remaining switches in a plastic bag to prevent from damp and corrosive gas and use them within a maximum of 2 weeks . 产品未打开包装的保存标准期限为6个月。打开包装后有剩余品时,应将剩余部分以胶袋包装好以同外界隔离,请进行合适的防湿,防腐蚀气体等处理后进行保管,保存期限为2周。</p>	
<p>Unless otherwise specified, The meaning of Electrically and mechanically performances shall be satisfied the following conditions in test standard: 若没有特殊要求, 试验标准中的“电气和机械性能无异常”是指要求满足以下条件:</p>	
Contact Resistance 接触电阻	1Ω Max.
Insulation Resistance 绝缘电阻	10MΩ Min.
Dielectric Voltage 抗电强度	100V AC for 1 minute Min. No dielectric breakdown. 100V AC 1 分钟, 无击穿现象发生。
Operating Force 操作力	42± 15gf
Other 其它	There should be no crack on switch's appearance 开关的外观应无断裂。

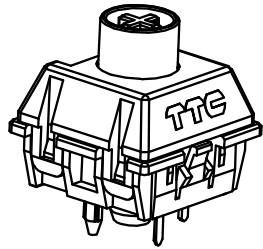

P.C.B mounting detail  
General Tolerance: ±0.05

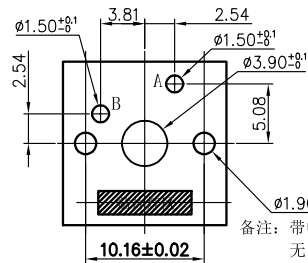

备注: 带中板建议尺寸1.90<sup>-0.10</sup><sub>-0</sub>  
无中板建议尺寸1.70<sup>-0.05</sup><sub>-0</sub>

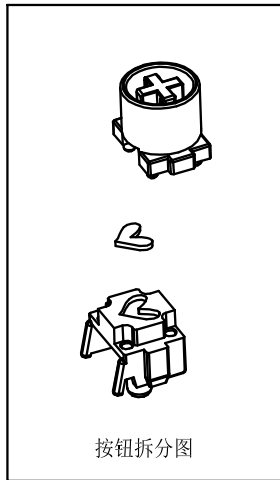

按钮拆分图

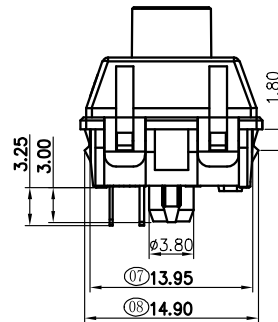
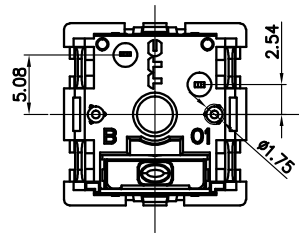
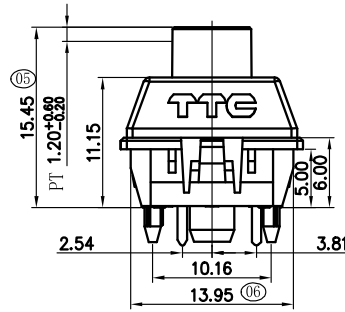
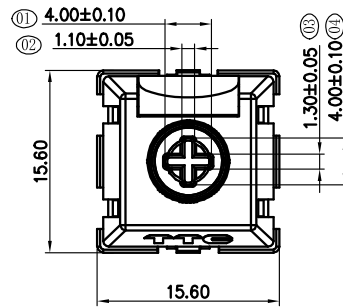
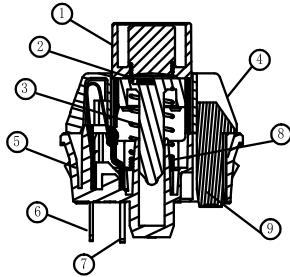

序号	名称	材料	数量	表面处理
1	上按钮	Plastic	1	透明
2	红心	PC	1	红色
3	下按钮	POM	1	本色
4	上盖	PC	1	透明黑
5	底座	PC	1	透明黑
6	接触片	Copper Alloy	1	材质镀银&金触点
7	端子	Copper Alloy	1	材质镀银&金触点
8	弹簧	SUS	1	镀金
9	聚光镜	PC/亚克力	1	透明

1. 功能参数:

额定负荷	12V DC Max. 2V DC Min 10mA DC Max. 10 μA DC Min
接触电阻	200m Ω max.
绝缘电阻	≥100M Ω DC100V
耐压	AC100V/1min/2mA.
操作力	42 ± 10gf
行程	1.2+0.6/-0.2 mm
机械寿命	100,000,000 次

2. 料号规则:

HX4B	-	TB	B	S	0	B	-	10	1	9	A	C
系	柄	盖	盖	盖	上	底	座	寿命	吸	衍生	弹	聚
列	壳	盖	盖	盖	盖	座	壳	盒	塑	生	簧	光
通	色	为	为	为	为	为	为	一	透	黑	盒	镜
孔	透	黑	黑	黑	黑	黑	亿	次	明	色	包	金
型	明	色	色	色	色	色	次	装	色	色	装	金

单位 UNIT	mm	一般公差 GENERAL TOLERANCE		名称 TITLE	TTC <sup>®</sup> TRANTEK ELECTRONICS CO., LTD.					
制图 DRAW		.X±0.50	ANGLES		巨人之心RGB版	料号 TITLE	HX4D-TBBS0B-1019AC			
设计 DESIGN		.XX±0.30	.X'±2'	图号 DWG NO.			HX4D-TBBS0B-1019AC	张数 SHEET	第1页,共1页	
审核 CHECKED		.XXX±0.10	.X'±1'		角法 PROJ.	比例 SCALE	2:1	版本 REV.	版 AO	图 C DWG
标准化 STANDARD										
批准 APPROVE										
表面 SA.										

标记 MARK	ECN 编号/变更内容 ECN NO./DEFINITION	修改 REVISE	核准 APPROVE	日期 DATE
1				
2				
3				
4				
5				
6				
7				
8				

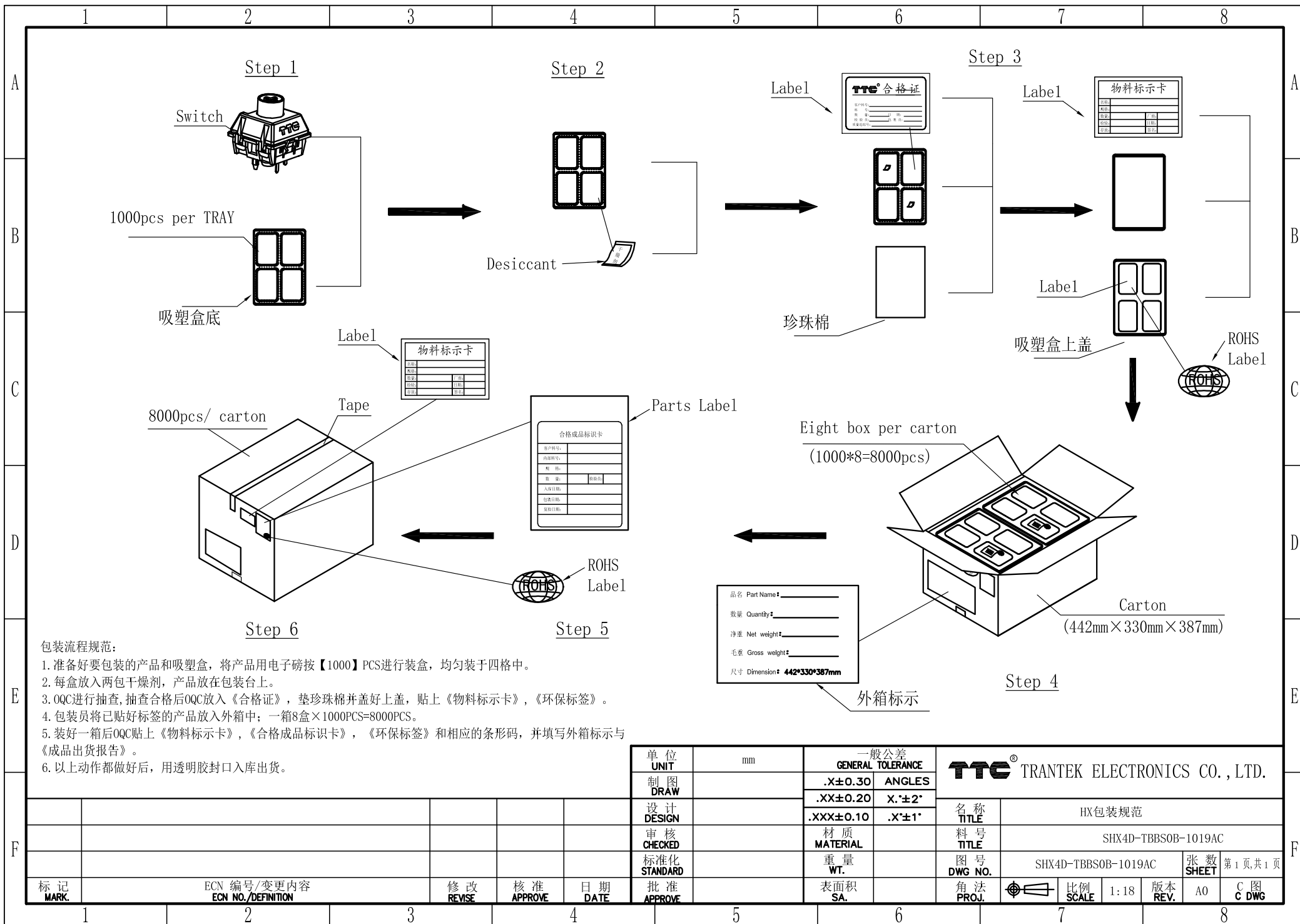

**包装流程规范:**

1. 准备好要包装的产品和吸塑盒，将产品用电子磅按【1000】PCS进行装盒，均匀装于四格中。
2. 每盒放入两包干燥剂，产品放在包装台上。
3. OQC进行抽查，抽查合格后OQC放入《合格证》，垫珍珠棉并盖好上盖，贴上《物料标示卡》，《环保标签》。
4. 包装员将已贴好标签的产品放入外箱中；一箱8盒×1000PCS=8000PCS。
5. 装好一箱后OQC贴上《物料标示卡》，《合格成品标识卡》，《环保标签》和相应的条形码，并填写外箱标示与《成品出货报告》。
6. 以上动作都做好后，用透明胶封口入库出货。

单位 UNIT	mm	一般公差 GENERAL TOLERANCE		TTC® TRANTEK ELECTRONICS CO., LTD.	
制图 DRAW		.X±0.30	ANGLES	名称 TITLE HX包装规范	
设计 DESIGN		.XX±0.20	X.'±2'		
审核 CHECKED		.XXX±0.10	.X'±1'	料号 TITLE SHX4D-TBBS0B-1019AC	
标准化 STANDARD		材质 MATERIAL			
批准 APPROVE		重量 WT.		图号 DWG NO.	SHX4D-TBBS0B-1019AC
标记 MARK	ECN 编号/变更内容 ECN NO./DEFINITION	修改 REVISE	核准 APPROVE	日期 DATE	角法 PROJ.
					张数 SHEET 第1页,共1页
					比例 SCALE 1:18
					版本 REV. AO
					C 图 C DWG