

SEIGAIHA

Assembly Guide

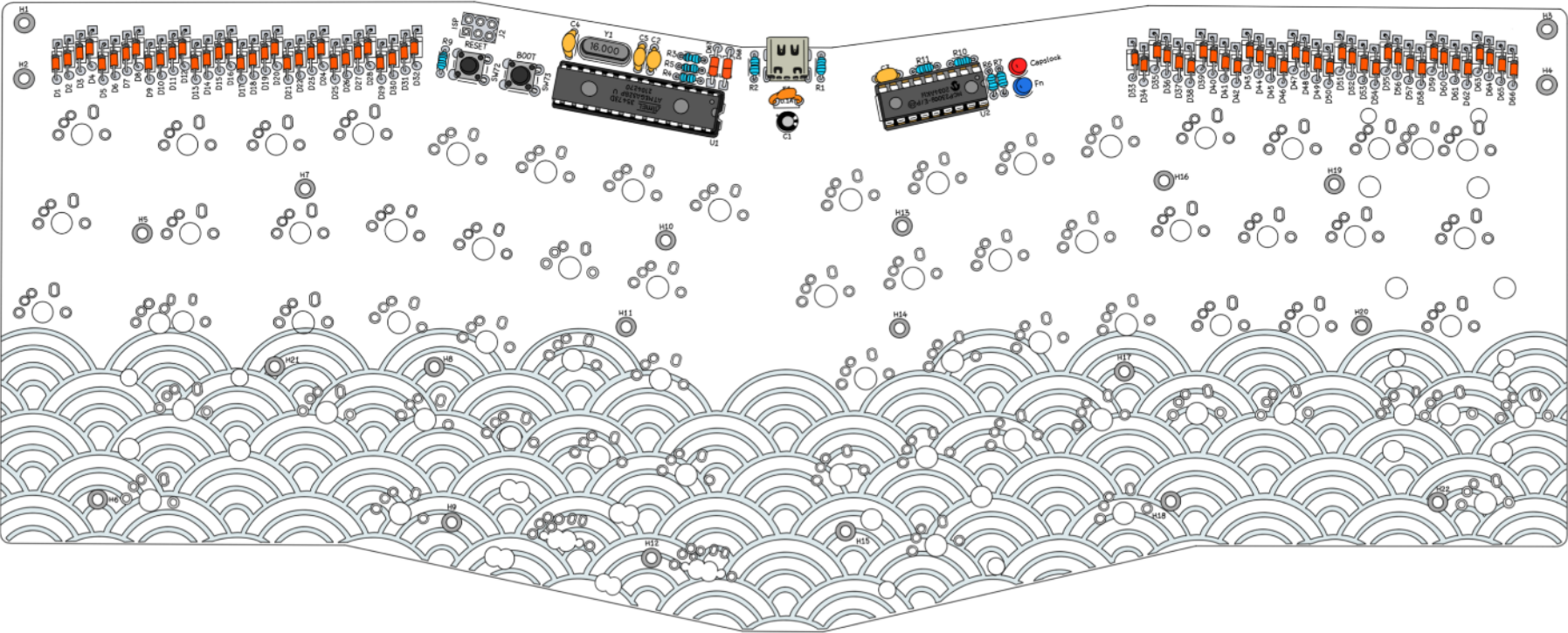

Yiancar Designs

Welcome to your new Seigaiha Keyboard!

Before we start, make sure you have the following:

- Soldering Iron • Solder
- Cutters
- Stabilizers
- Mechanical Switches (preferably PCB mount) • Keycaps
- USB C cable

This kit is designed with only through-hole components.

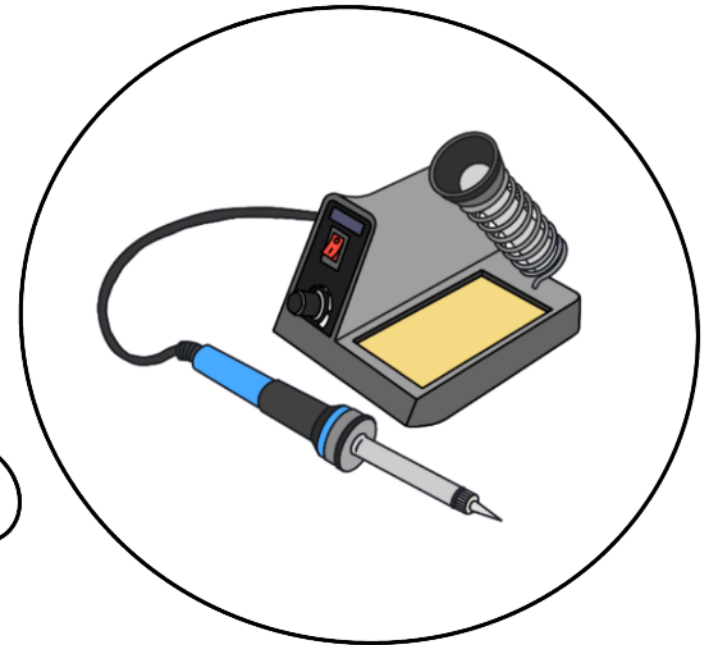
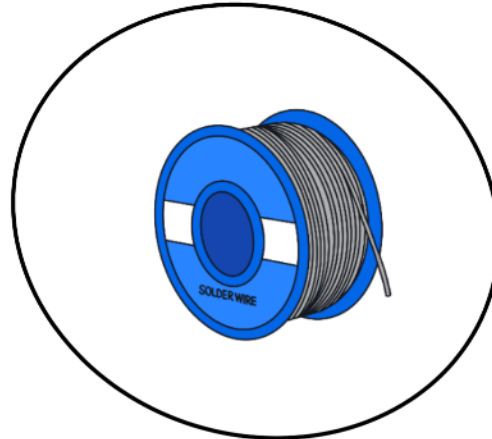
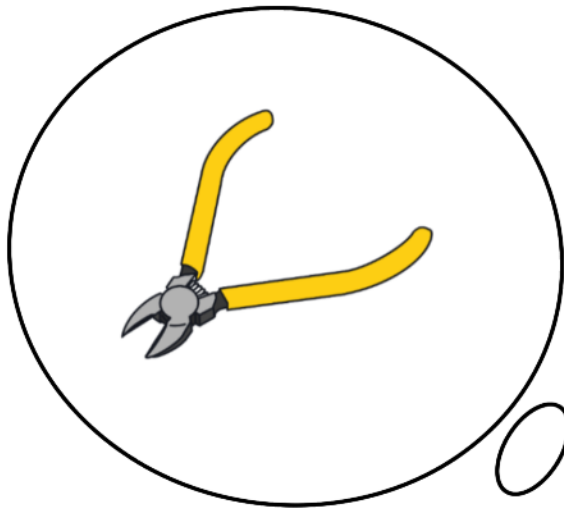

Components List

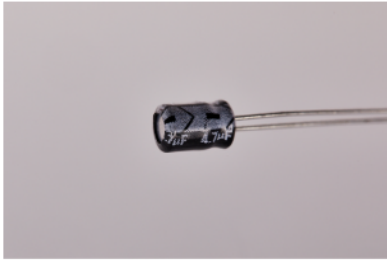

4.7uF Electrolytic Capacitor

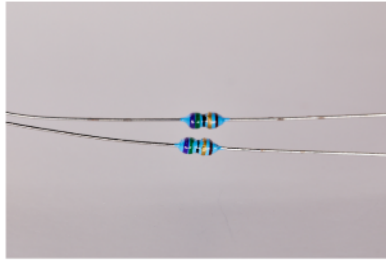

75 Ohm Resistors
Colours: Purple, Green, Black Gold, Brown

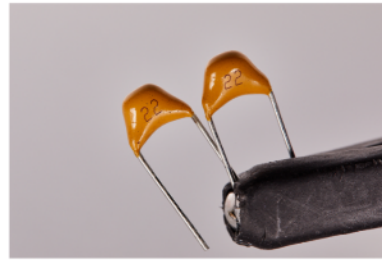

22pF Ceramic Capacitors
Markings: 22

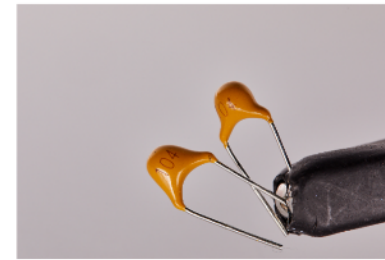

100nF Ceramic Capacitors
Markings: 104

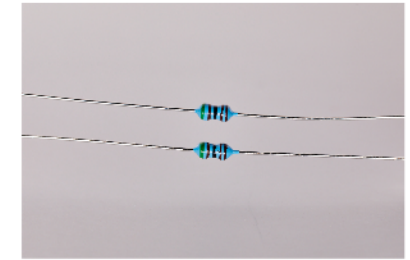

5.1k Ohm Resistors
Colours: Green, Brown, Black, Brown, Brown

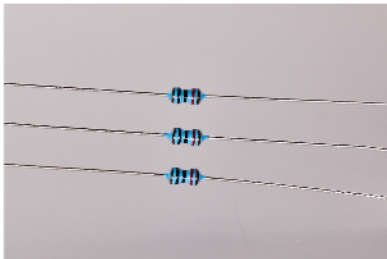

10k Ohm Resistor
Colours: Brown, Black, Black, Red, Brown

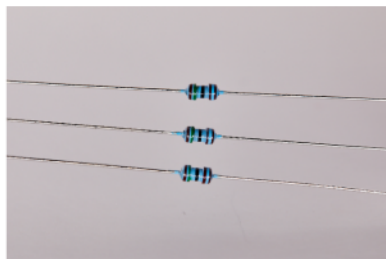

1.5k Ohm Resistors
Colours: Brown, Green, Black, Brown, Brown

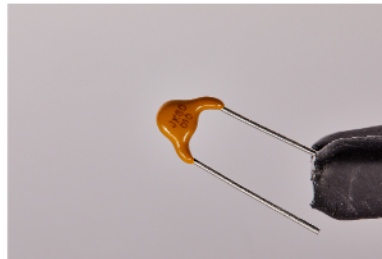

500mA Fuse



Zener Diodes 3.6V,
x2 loose pieces

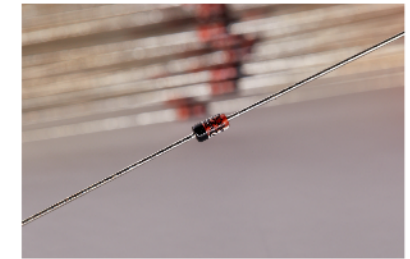

1N4148 Diodes, x66 loose pieces in the bag together with the resistors



Blue and red LEDs
Note: long leg is positive



16Mhz Crystal



Reset and Boot Switches

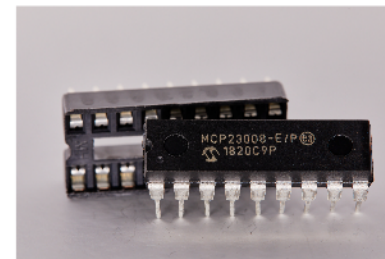

MCP23008 Port Expander and Socket

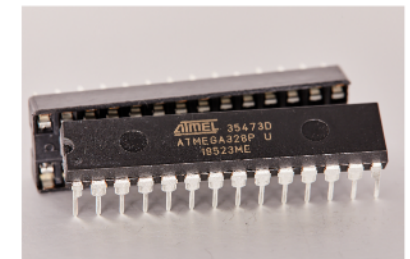

ATmega328P Microcontroller and Socket

Components List



USB-C Connector



M2 Screws



M2 Spacers



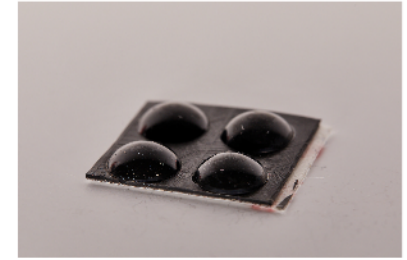

M2 Nuts

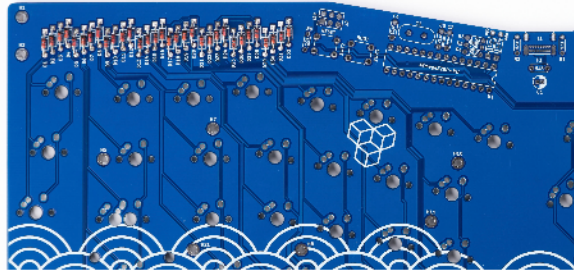

Rubber Feet

Assembly Instructions



Step 1
Solder 1N4148 Diodes under the graphic as shown in the picture. The black line from the diodes goes to the top. 

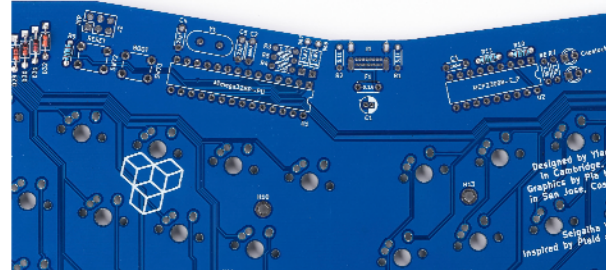

Step 2
Solder the x3 10k Ohm resistors; R9, R10, and R11. Those components have no specific orientation.

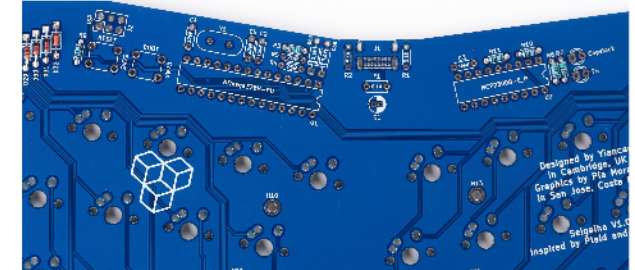

Step 3
Solder the x3 1.5k Ohm resistors; R3, R6, and R7. Those components have no specific orientation.

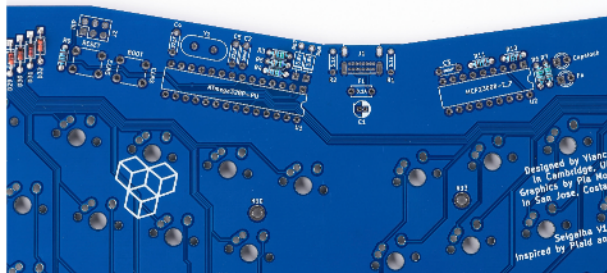

Step 4
Solder the x2 75 Ohm resistors; R4 and R5. Those components have no specific orientation.

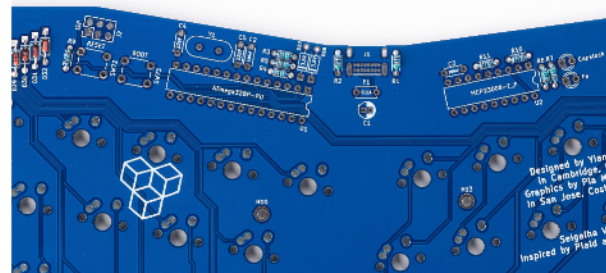

Step 5
Solder the x2 5.1k Ohm resistors; R1 and R2. These components have no specific orientation.

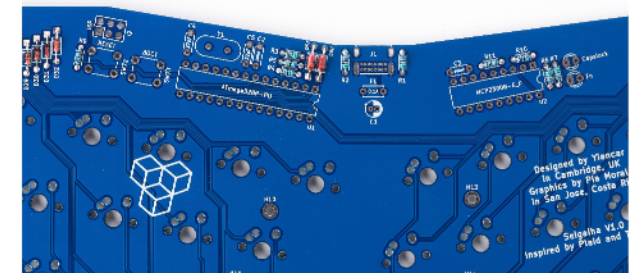

Step 6
Solder the x2 Zener diodes; D67 and D68. The black line is at the bottom. 

Assembly Instructions

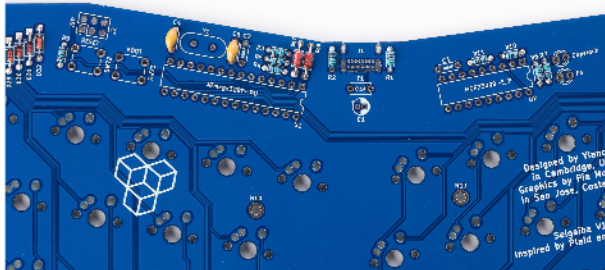

Step 7

Solder the x2 22pF capacitors; C4 and C5.

Do not over-pull the legs through the PCB. These capacitors are very fragile and can crack. These components have no specific orientation.

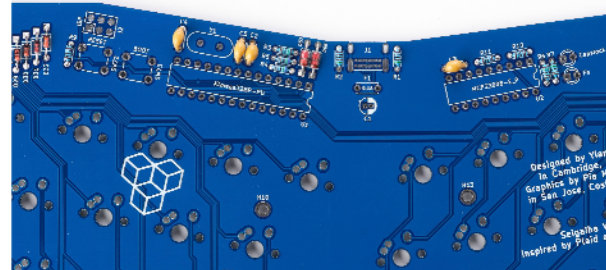

Step 8

Solder the x2 100nF capacitors; C2 and C3.

These components have no specific orientation.

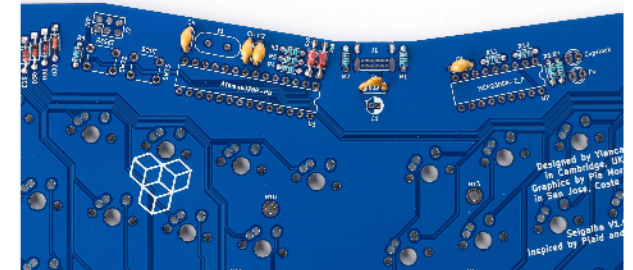

Step 9

Solder the fuse, F1. This component has no specific orientation.

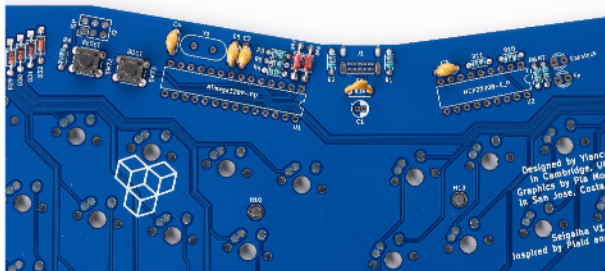

Step 10

Solder the x2 switches; SW72 and SW73.

These components have no specific orientation.

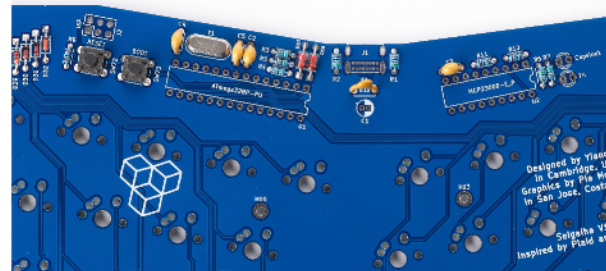

Step 11

Solder the Crystal Y1. These components have no specific orientation.

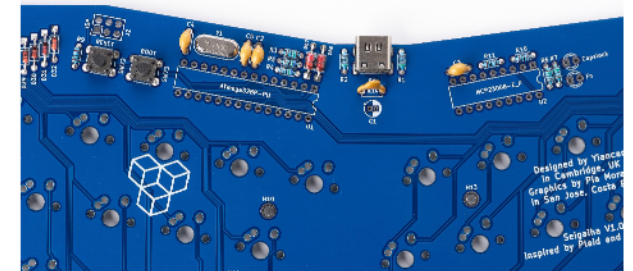



Step 12

Solder the USB socket. The small pins might not come through the PCB but still add a small amount of solder. Solder the shield pins last.

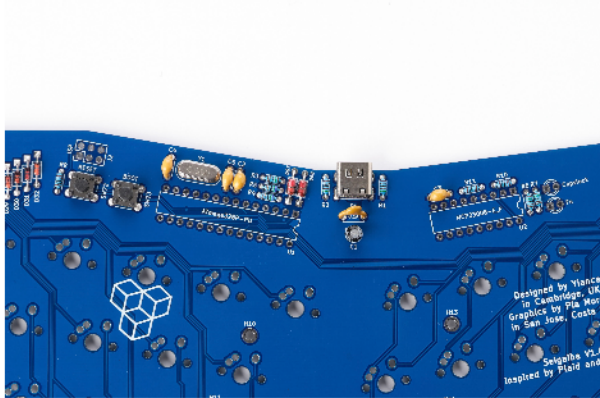

Assembly Instructions



Step 13
Solder the electrolytic capacitor, C1.
Negative (-) goes to the right. 

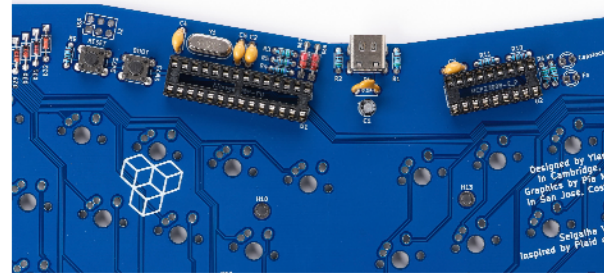

Step 14
Solder the x2 chip sockets. The small one goes to the U2 and the big one goes to U1, as in the picture.

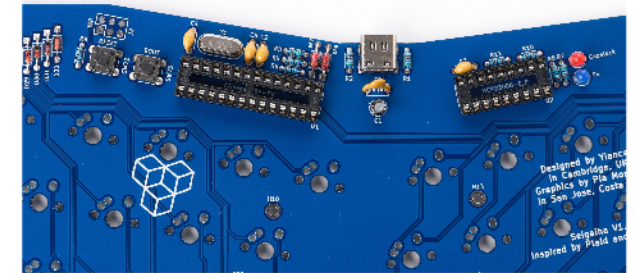

Step 15
Solder the LEDs as shown in the picture.
The long leg is the positive. 

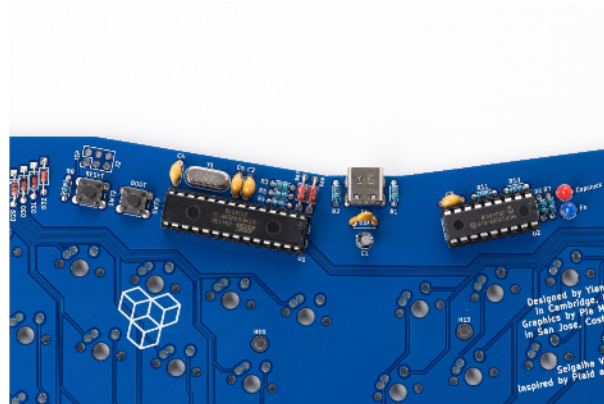

Step 16
Put the x2 chips in their sockets. The MCU is pre-programmed with the default ANSI keymap. Re-programming instructions are on page 9. The U1 chip's semi-circle mark goes to the right. 
The U2 semi-circle mark goes to the right. Bend the legs of the chips inwards to fit in the sockets!

Assembly Instructions

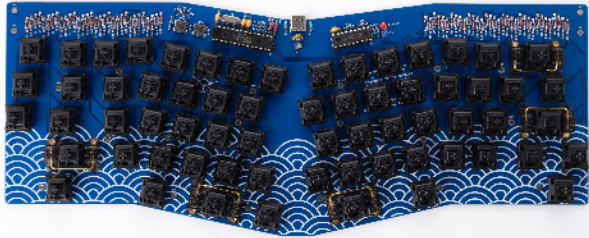

Step 17
Solder all the switches according to your desired layout. Add the stabilizers.



Step 18
Screw the x18 M2 screws; H5, H6, H7, H8, H9, H10, H11, H12, H13, H14, H15, H16, H17, H18, H19, H20, H21, and H22. The screws are inserted from the top of the top PCB.

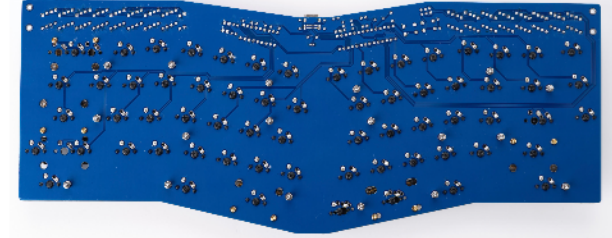

Step 19
Screw x36 M2 nuts, 2 on each of the 18 screws from the bottom.



Step 20
Put the x4 M2 screws from the bottom of the bottom PCB. These screws are for the plexiglass.



Step 21
Put the x8 M2 nuts, 2 for each screw, to the top of the bottom PCB.



Step 22
Insert the bottom PCB and the top PCB together. Secure the x4 plexiglass screws with the x4 spacers.

Assembly Instructions

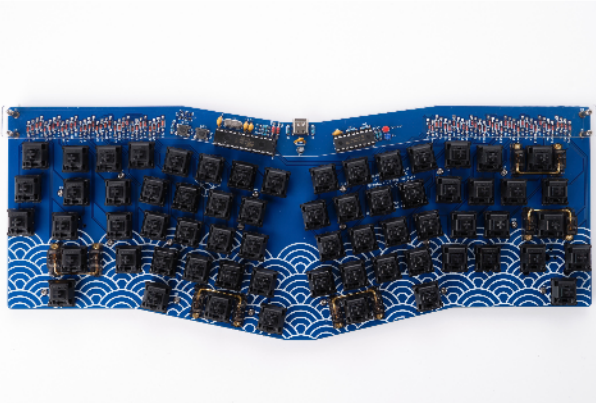

Step 23
Place the plexiglass on top of the spacers and secure it with x4 M2 screws.



Step 24
Turn the keyboard upside down and secure the bottom PCB with the last x18 M2 nuts.



Step 25
Place the x8 rubber feet at the bottom.
Done!



Congratulations! You made it!

Please see the following pages for programming instructions;)

Programming Instructions Using VIA

The keyboard is shipped with VIA enabled. If you have programmed using GMK configurator and want to go back to VIA please flash the default firmware from our website.

Step 1

Download VIA from:

<https://github.com/the-via/releases/releases/latest>

If you are using Windows, download the .msi.

If you are using MacOS, download the .dmg.

Step 2

With the keyboard connected, open VIA.

Step 3

To change the keymap, press on the desired key and then select the new keycode from below.

The change is instantaneous.

To change layouts, use the layout tab.

 [via-1.3.1-linux.ApplImage](#)

 [via-1.3.1-linux.deb](#)

 [via-1.3.1-mac.dmg](#)

 [via-1.3.1-mac.dmg.blockmap](#)

 [via-1.3.1-win.exe](#)

 [via-1.3.1-win.exe.blockmap](#)

 [via-1.3.1-win.msi](#)

Programming Instructions Using QMK

Step 1

Download the latest QMK Toolbox from:

https://github.com/qmk/qmk_toolbox/releases

If you are using Windows download the “.exe”. If you are using MacOS download the “.pkg”.

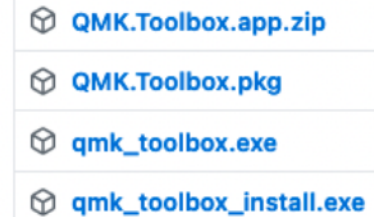

Step 2

Install the downloaded package.

Step 3

Create your desired keymap from:

https://config.qmk.fm/#/seigaiha/LAYOUT_alice_split_bs

Select the desired layout first.



Step 4

Press Compile button. Make sure the compilation has completed successfully.

Programming Instructions Using QMK

Step 5

Press FIRMWARE button to download the ".hex".

Step 6

In QMK toolbox press Open and select the downloaded ".hex". Select atmega328p from the microcontroller menu.

Step 7

Unplug your keyboard from your computer. Plug your keyboard back to your computer while holding the ESC key on the keyboard. QMK toolbox should detect USBasp. Release the ESC key.

Step 8

Press the Flash button in QMK toolbox. Once you see the Success message, unplug and replug your keyboard.

Done! Enjoy your new keymap!

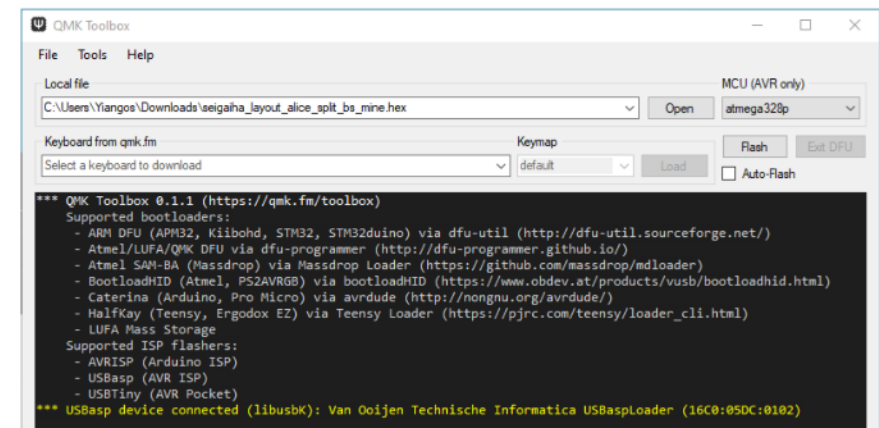

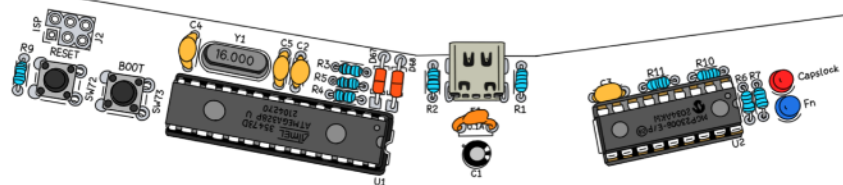

yiancar-designs.com



Yiancar Designs

Thank you!



hello@yiancar-designs.com

