

ABIDE BY ROHS

Pale Blue Shaft

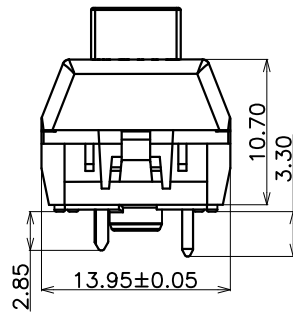

SWITCH FUNCTION

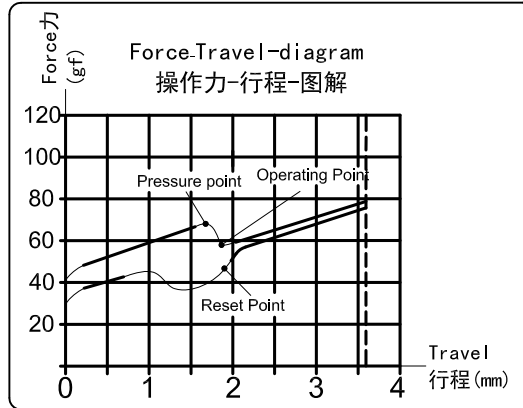
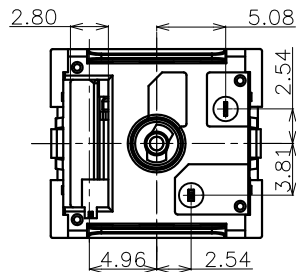
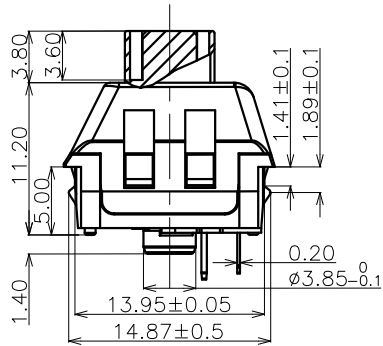
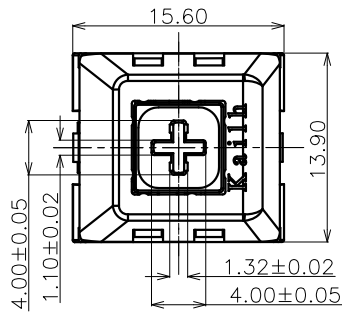
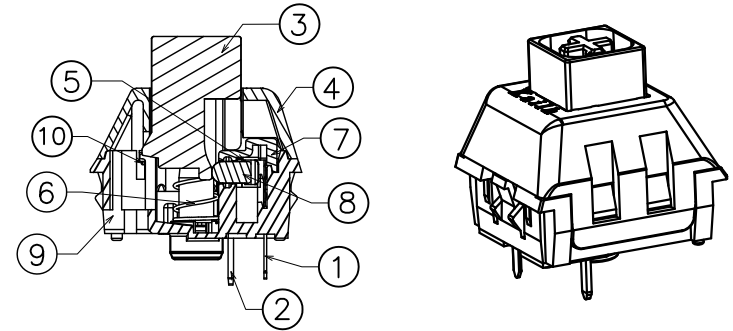
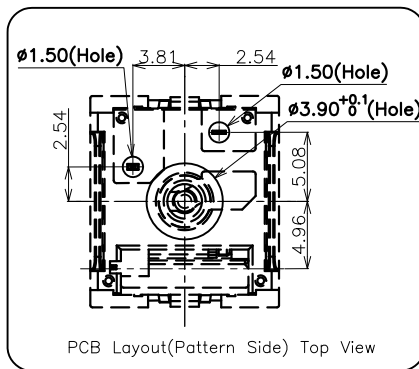
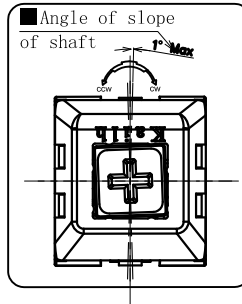
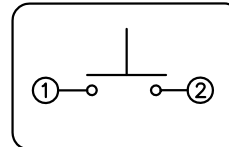

- Specification :
- 1. Rating : 12 VAC/DC max. 2 VDC min. 10mA AC/DC max. 10 μA DC min.
 - 2. Contact Resistance : 200mΩ Max
 - 3. Insulation Resistance : 100MΩ Min. (DC100V)
 - 4. Withstand Voltage : AC100V (50-60Hz) for 1 minute
 - 5. Tactile Force : 70±10gf
 - 6. Operation Force : 60±15gf
 - 7. Return Force ≥15gf
 - 8. Conduction travel: 1.80mm±0.3mm
 - 9. Total travel: 3.6±0.3mm
 - 10. Operating Life : 80,000,000 Cycles(min).
 - 11. Degree of protection: IP56 (excluding the terminals)
<Feel is allowed to have difference before and after life test>

| | | | | | | |
|------|------------------|---------|------|-----------------|------------|--------|
| ⑩ | Torsional Spring | — | 1 | Stainless Steel | Nature | — |
| ⑨ | Base | — | 1 | PA66 | White | — |
| ⑧ | Slider | — | 1 | POM | Green | — |
| ⑦ | Protecting Cover | — | 1 | PA66 | Nature | — |
| ⑥ | Spring | — | 1 | Stainless Steel | Nature | — |
| ⑤ | Contact | — | 2 | Composite gold | — | — |
| ④ | Cover | — | 1 | PC | Nature | — |
| ③ | Keystroke | — | 1 | POM | Pale Blue | — |
| ② | Static Plate | — | 1 | Brass | Plating Ni | — |
| ① | Movable Plate | — | 1 | Copper Alloy | Nature | — |
| ITEM | PART NAME | TER'NO. | QTY. | MATERIAL | FINISHING | REMARK |

| | | | | | |
|----------------|---------|------------|-------------|--|--------------|
| APPROVALS | | DATE | | DONGGUAN CITY KAIHUA ELECTRONICS CO.,LTD | |
| DRAWN | L.Zhang | 2017.06.15 | Kailh | | |
| CHECKED | | | TITLE: | Keystroke Switch (Pale blue shaft) | |
| APPROVALS | | | PART NO. | CPG1511F01S06 | |
| TOLERANCES ARE | | | 30<L | ±0.30 | ANGLE |
| | | | 10<L≤30 | ±0.20 | |
| | | | 5<L≤10 | ±0.15 | |
| | | | L≤5 | ±0.10 | |
| | | | UNIT: mm | SCALE: 1:1 | PROJ: |
| | | | DRAWING NO. | | SHEET 1 OF 1 |

| | | | | | | | |
|---------|------|------------|-----|--------------|---------|--------|--------|
| ECN NO. | REV. | DATE. | NEW | DESCRIPTION. | CHANGE. | CHECK. | APPRO. |
| | A | 2017.06.15 | | | L.Zhang | | |



凱華電子
KAIHUA EEELETRONICS

Document Number:

KH-PS1706-35

产品规格书

Product Specification

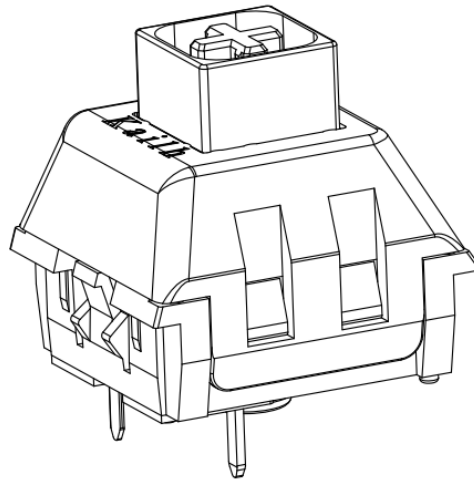

Pale Blue shaft 浅蓝轴

| | | | | | |
|---------------------------|-----|-----------------------------------|--|------------------|-------------------|
| P/N: CPG1511F01S06 | | | Title : PG1511F Keyboard Switch | | |
| Rev. | ECN | Release and Revision Description: | Prepared By /Date: | Checked By/Date: | Approved By/Date: |
| A | — — | New releasing 初版发行 | 张林/2017.06.15 | 易平/2017.06.15 | 王锋/2017.06.15 |
| | | | | | |
| | | | | | |
| | | | | | |



| | | | |
|------------------------------|----------------------------------|-------------------|----------------------|
| P/N: CPG1511F01S06 | DOC. No.: KH-PS1706-35 | Rev.: A | Page: 2/11 |
|------------------------------|----------------------------------|-------------------|----------------------|

Content

目录

| | |
|--|-------|
| 1. Scope/范围: | 3 |
| 2. Product Application/产品应用: | 3 |
| 3. Technology Parameters/技术参数 | 3 |
| 4. Ratings/额定性能要求 | 3 |
| 5. Profile Dimensions /外形尺寸 | 3 |
| 6. Electrical Performance/电气性能 | 4 |
| 7. Mechanical Performance/机械性能 | 5-6 |
| 8. Environmental Performance/环境性能 | 7-8 |
| 9. Recommended PCB Layout/推荐的 PCB 安装焊盘规格 | 9 |
| 10. Loading Parameter Specification/荷重参数规格 | 10 |
| 11. Packaging/包装 | 10-11 |
| 12. Precaution/注意事项 | 11 |



| | | | |
|------------------------------|----------------------------------|-------------------|----------------------|
| P/N: CPG1511F01S06 | DOC. No.: KH-PS1706-35 | Rev.: A | Page: 3/11 |
|------------------------------|----------------------------------|-------------------|----------------------|

1. Scope/范围:

This Product Specification covers the requirement of Mechanical Keyboard switch on product performance, test methods and quality assurance provisions.
本规格书内容涵盖机械键盘开关产品的要求，包括性能指标、测试方法及质量保证方面等。

2. Product Application/产品应用:

Mainly applied on computer keyboards, cash registers, industrial equipment and Man-Machine interface.
主要适用于电脑键盘，收银机、工业设备和人机界面。

3. Technology Parameters/技术参数

Ambient Humidity 工作湿度: 45~85% R.H.;

Operating Temperature Range 使用温度范围: -10℃~+70℃;

Storage Temperature Range 保存温度范围: -20℃~+70℃;

Suggested storage period 贮存期限: about 6 months 最多 6 个月

Require the tin part on the switch terminals should keep good after storage guarantee date
要求贮存期后开关端子部分上锡仍然良好。

Normal Condition:

Ambient temperature 环境温度: 20±2℃

Relative humidity 相对湿度: 65%±5% R.H.;

Air pressure 气压: 86~101KPa;

4. Ratings/额定性能要求

Rating 额定负荷: 12V AC/DC max. 2V DC min.
10mA AC/DC max. 10 μ A DC min.;

Insulation Resistance 绝缘电阻: ≥100MΩ/DC 100V;

Withstand Voltage 耐电压: 100 AC 1 Minute;

Mechanical Life 机械寿命: 80,000,000 Cycles (Without Load).

5. Profile Dimensions /外形尺寸

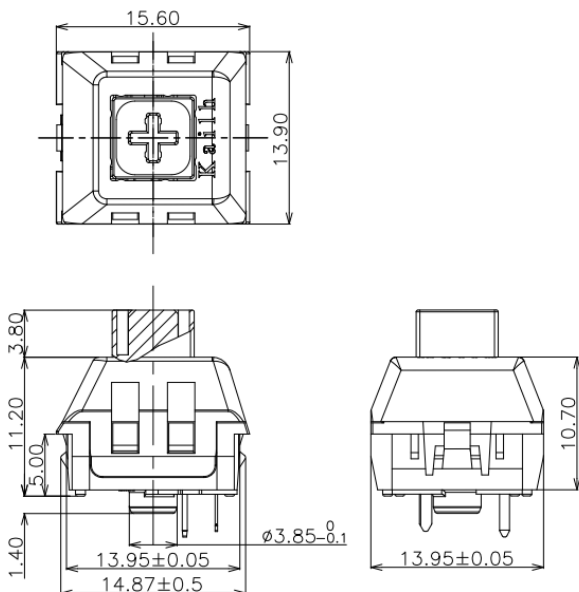

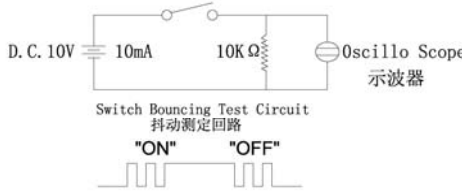

6. Electrical Performance/电气性能

| Item 项目 | Description 项目描述 | Test Condition 测试条件 | Requirement 规格要求 |
|------------|--|--|--|
| 6.1 | Contact Resistance 接触电阻 | <p>Static load: (Operation force)x2, which is applied on the center of Switch stem. 静态负载: 动作力的 2 倍, 施加在手柄中心.</p> <p>Measurement tool: Contact resistance Meter. 测量工具: 微电流接触电阻计(1KHz, 20mV,5~50mA)</p> <p>在低电流 (≤100mA) 条件下测试. Measured at low current (100mA or less).</p> | <p>200mΩ Max 200mΩ 以下</p> |
| 6.2 | Insulation Resistance 绝缘电阻 | <p>Apply a Voltage of DC 100 V for 1 minute, according to the below method. (1) Between terminals. (2) Between terminal and Body.</p> <p>输入 100V DC 电压 1 分钟, 按如下接触方法测试: (1) 端子与端子之间. (2) 端子与外壳之间.</p> | <p>100MΩ Min 100 兆欧以上</p> |
| 6.3 | Dielectric withstanding voltage 耐电压 | <p>Apply a Voltage of AC100 V (50~60Hz) for 1 minute, according to the below method. (1) Between terminals. (2) Between terminal and Body.</p> <p>输入 100V AC 电压 1 分钟, 按如下接触方法测试: (1) 端子与端子之间. (2) 端子与外壳之间.</p> | <p>No evidence of breakdown 无瞬断、击穿等破坏.</p> |
| 6.4 | Bouncing 触点抖动 | <p>Operation speed: 3~4 times/s 操作速度: 每秒 3~4 次</p> <p>Oscillo scope 示波器</p> <p>Switch Bouncing Test Circuit 抖动测定回路.</p>  <p>Switch Bouncing Test Circuit 抖动测定回路</p> <p>"ON" "OFF"</p> | <p>Before Life cycle: On:5ms MAX,5 毫秒以下 Off: 5ms MAX,5 毫秒以下</p> <p>After Life cycle: On:10ms MAX,10 毫秒以下 Off: 10ms MAX,10 毫秒以下</p> |

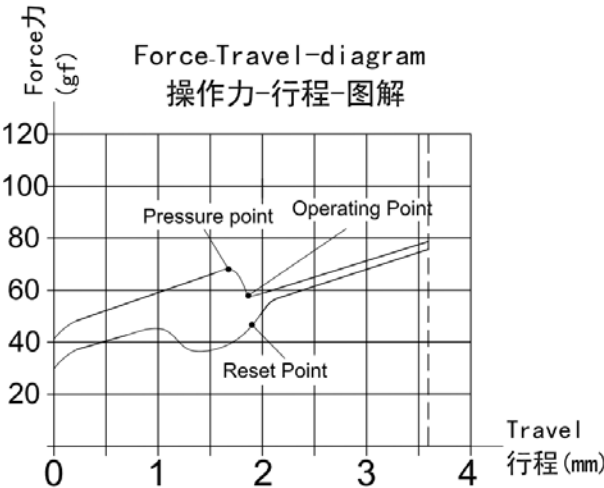
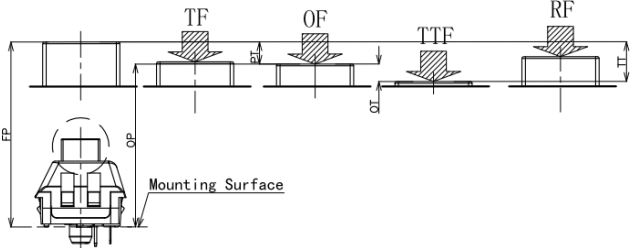

7. Mechanical Performance/机械性能

| Item 项目 | Description 项目描述 | Test Condition 测试条件 | Requirement 规格要求 |
|------------|---------------------------|---|------------------------|
| 7.1 | Load Curve 荷重曲线 | <p>Place the vertical direction of switch operation and gradually increase the load applied to the center of the stem until it stop. 开关的动作方向为垂直放置，向手柄中心逐渐施加负荷直到停止.</p>  <p style="text-align: center;">Force-Travel-diagram 操作力-行程-图解</p> | See page 11 见第 11 页 |
| 7.2 | Loading parameter 荷重参数 | <p>Place the vertical direction of switch operation and gradually increase the load applied to the center of the stem until it stop. 开关的动作方向为垂直放置，向手柄中心逐渐施加负荷直到停止.</p>  | See page 11 见第 11 页 |

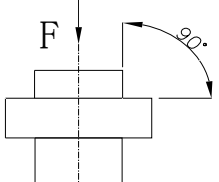
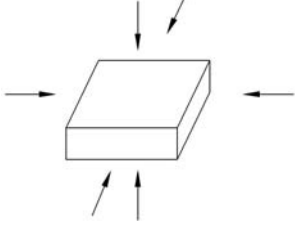

| | | | |
|-----|-------------------------------------|---|---|
| 7.3 | Static Strength 静止强度 | <p>A static load of 3kgf shall be applied in the direction of button operation for a period of 60 seconds. 在手柄动作方向施加 3kgf 的静负荷 60 秒, 然后测试参数.</p>  | <p>No damage (Electrical) And mechanical) 电气和机械性能正常.</p> |
| 7.4 | Stem Pull Strength 手柄拉拔强度 | <p>Break by a pull force applied opposite to the direction of stem operation. 在推柄动作方向反向垂直施加拉力, 使其破坏的程度.</p> | <p>5kgf Min</p> |
| 7.5 | Shock 机械冲击 | <p>Measured by according to the below condition: (1) Acceleration: 80g 加速度 (2) Cycles of test:3 cycles each in 6 directions, for a total of 18 cycles. 试验次数: 每个方向 3 次, 6 个方向共 18 次.</p>  | <p>Shall meet No.6, 7.1, 7.2. 满足 6, 7.1, 7.2 要求.</p> |
| 7.6 | Life Test 寿命测试 | <ol style="list-style-type: none"> 1) D.C.12V 10mA resistance load D.C 12V 10mA 电阻负荷 2) Operation speed : 5-6 times / s 动作速度: 5-6 次/ 秒 3) Push force : 150gf 按力: 150gf 5) Push travel : 3.6mm 按压行程: 3.6mm 6) Operation number: 80,000,000cycles 动作次数: 80, 000, 000 次 | <p>Contact resistance: 1 Ω Max 接触电阻: 1 欧以下 Bouncing: 10ms Max 触点抖动: 10 毫秒以下 Operation force: Variation rate within ± 30% 操作力的变化范围在初始值的±30%以内.</p> |



8. Environmental Performance/环境性能

| Item 项目 | Description 项目描述 | Test Condition 测试条件 | Requirement 规格要求 | | | | | | | | | | | | | | | |
|-----------------|--------------------------------|---|--|-------------------|--------------------------|-----------------|-------|----|--|--------|----|--|-------|----|--|-------|----|--|
| 8.1 | Cold test 耐寒性 | (1) Temperature : - 20±2℃ 温度: - 20±2℃ (2) Duration of test: 48h 持续时间: 48 小时 (3) Take off a drop water 去掉水珠 (4) Standard conditions after test : 1h 试验后的放置条件: 1 小时 | Contact resistance: 200mΩ Max Shall meet : No. 6.2 to 6.4 No. 7.1 to 7.2 接触电阻 200mΩ 以下 满足: No. 6.2 to 6.4 No. 7.1 to 7.2 | | | | | | | | | | | | | | | |
| 8.2 | Heat test 耐热性 | (1) Temperature : 70±2℃ 温度: 70±2℃ (2) Duration of test: 48h 持续时间: 48 小时 (3) Take off a drop water 去掉水珠 (4) Standard conditions after test : 1h 试验后的放置条件: 1 小时 | Contact resistance: 200mΩ Max Shall meet : No. 6.2 to 6.4 No. 7.1 to 7.2 接触电阻 200mΩ 以下 满足: No. 6.2 to 6.4 No. 7.1 to 7.2 | | | | | | | | | | | | | | | |
| 8.3 | Temperature cycle 温度循环 | (1) Test cycles: 5 cycles 试验周期: 5 个周期 (2) Standard condition after test:1h 试验后的放置条件: 1 小时 <table border="1" data-bbox="432 1368 1037 1559"> <thead> <tr> <th></th> <th>Temperature 温度</th> <th>Duration of test 持续时间</th> </tr> </thead> <tbody> <tr> <td>1 cycle 一次循环</td> <td>20±5℃</td> <td>1h</td> </tr> <tr> <td></td> <td>-20±5℃</td> <td>1h</td> </tr> <tr> <td></td> <td>20±5℃</td> <td>1h</td> </tr> <tr> <td></td> <td>70±5℃</td> <td>1h</td> </tr> </tbody> </table> | | Temperature 温度 | Duration of test 持续时间 | 1 cycle 一次循环 | 20±5℃ | 1h | | -20±5℃ | 1h | | 20±5℃ | 1h | | 70±5℃ | 1h | Contact resistance: 200mΩ Max Shall meet : No. 6.2 to 6.4 No. 7.1 to 7.2 接触电阻 200mΩ 以下 满足: No. 6.2 to 6.4 No. 7.1 to 7.2 |
| | Temperature 温度 | Duration of test 持续时间 | | | | | | | | | | | | | | | | |
| 1 cycle 一次循环 | 20±5℃ | 1h | | | | | | | | | | | | | | | | |
| | -20±5℃ | 1h | | | | | | | | | | | | | | | | |
| | 20±5℃ | 1h | | | | | | | | | | | | | | | | |
| | 70±5℃ | 1h | | | | | | | | | | | | | | | | |
| 8.4 | Soldering heat test 耐焊接热 | Soldering area: T/2 of PWB thickness. (PWB: T=1.6mm) 焊接面积: 印刷基板的 1/2 厚度处 Soldering temperature: 260±5℃ Soldering time: 3±0.5s 焊接温度: 260±5℃ 焊接时间: 3±0.5 秒 | Appearance: No abnormality. 外观无异常 | | | | | | | | | | | | | | | |

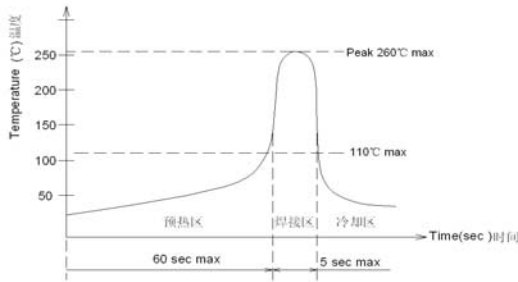

| | | | |
|-----|-----------------------|--|--|
| 8.5 | Solder ability 可焊性 | <p>1. Hand soldering 手工焊接: Please practice according to below condition: (1) Soldering Temperature : $350 \pm 5^{\circ}\text{C}$ 焊接温度: $350 \pm 5^{\circ}\text{C}$ (2) Continual soldering time: $3 \pm 0.5\text{s}$ 连续焊接时间: 3 ± 0.5 秒 (1) Capacity of soldering iron: $\leq 20\text{w}$ 电烙铁功率: 20 瓦以下</p> <p>2. Automatic PIP soldering 自动插板焊接: For the product of T/H according to below condition:</p> <p style="text-align: center;">波峰焊温度曲线图(单波峰)</p>  | At least 95% of surface area of immersed portion shall be covered by solder. 浸焊面积大于 90%以上. |
| 8.6 | Humidity test 耐湿性 | <p>(1) Temperature : $60 \pm 2^{\circ}\text{C}$ 温度: $60 \pm 2^{\circ}\text{C}$ (2) relative humidity: 90~95% R.H. 相对湿度:90~95% R.H. (3) Duration of test: 48h 持续时间: 48 小时 (4) Take off a drop water 去掉水珠 (5) Standard conditions after test: 1h 试验后的放置条件: 1 小时</p> | Contact resistance: $200\text{m}\Omega$ Max Shall meet : No. 6.2 to 6.4 No. 7.1 to 7.2 接触电阻 $200\text{m}\Omega$ 以下 满足: No. 6.2 to 6.4 No. 7.1 to 7.2 |
| 8.7 | Salt Spray 盐雾测试 | <p>Apply the following environment to test: 根据下列条件进行测试: (1) Temperature : $35 \pm 5^{\circ}\text{C}$ 温度: $35 \pm 5^{\circ}\text{C}$; (2) Salt water density: $5 \pm 1\%$ 盐水浓度: $5 \pm 1\%$; (3) Duration: 12hours 持续时间: 12 小时; (4) After test, the salt deposit shall be removed by running water. 实验后将盐沉积物用水冲掉</p> | Appearance: No corrosion spot, no crack, no base plate naked. 外观: 无腐蚀点, 无裂纹, 无裸露基材. Contact Resistance: $200\text{m}\Omega$ Max 接触电阻: 200 毫欧以下 |



| | | | |
|-----|--|--|---|
| 8.8 | Protection Against ingress of dust(IP5X) 防尘 | <p>The switches are placed in a position of normal use inside the test chamber. The test is carried out according to the second enclosure of IEC60529/GB4208. The test shall be continued for a period of 8h.</p> <p>测试样品以正常使用位置在防尘箱中安装；按 IEC60529 或 GB4208 防护标准测试条件进行试验；试验应持续 8 小时；</p> | <p>After test: Operating is normal Between terminals, terminal and surface of the crust, Dielectric withstand in voltage $\geq 100V$</p> <p>动作正常； 端子之间及端子与外壳表面耐电压强度$\geq 100V$</p> |
| 8.9 | Protection against ingress water(IPX6) 防水 | <p>The switches are placed in a position of normal use inside the test table. The test is carried out according to the second enclosure of IEC60529/GB4208.</p> <p>测试样品以正常使用位置在防尘箱中安装；按 IEC60529 或 GB4208 防护标准测试条件进行试验；</p> | <p>After test: Operating is normal. Water don't enter electric parts of the switch inside. Between terminals, terminal and surface of the crust, Dielectric withstand in voltage $\geq 100V$</p> <p>动作正常； 水不能进入开关内带电部份 端子之间及端子与外壳表面耐电压强度$\geq 100V$</p> |

9. Recommended PCB Layout 推荐的 PCB 安装焊盘规格

Mounting Options 安装选项

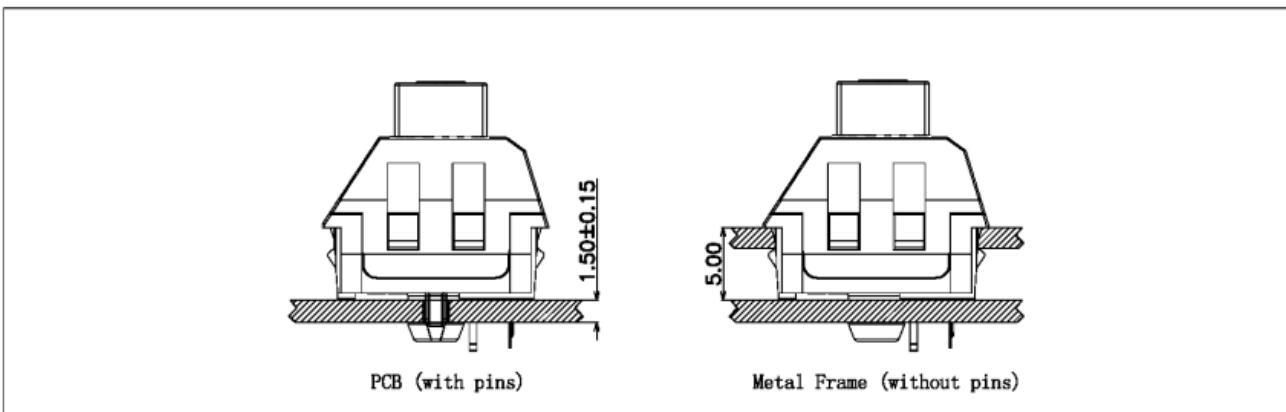

Circuit Board Layouts 电路板布局

Grid line spacing = 1.27mm 网格线间距= 1.27毫米

Keypad switch without fixation pins
按键开关不带定位柱

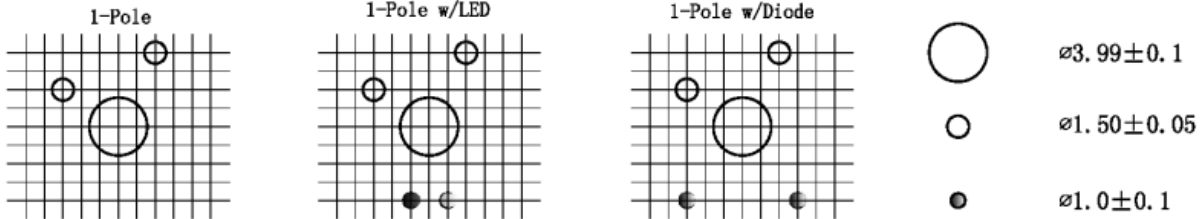

Keypad switch with fixation pins
按键开关带定位柱

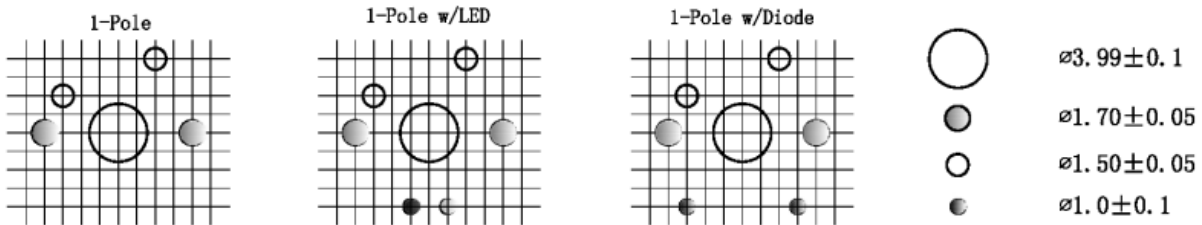

Metal Frame Cutout Dimensions

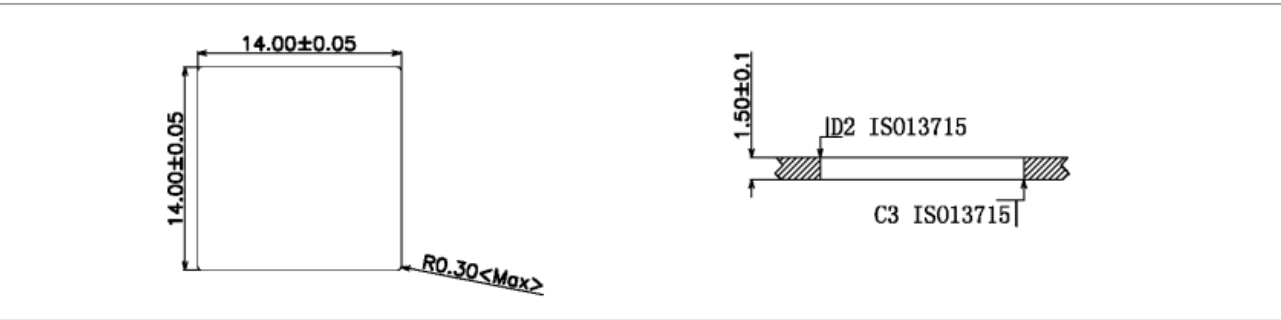

10. Loading Parameter (TT/PT/OT /OF/TF/RF) Specification 荷重参数规格：

| Parameter | Unit | Specification | Remark |
|-----------|------|---------------|--------|
| TT(总行程) | mm | 3.60±0.3 | |
| PT(导通行程) | mm | 1.80±0.3 | |
| OT(过行程) | mm | 1.30 | Min. |
| OF(动作力) | gf | 60±15 | |
| TF(触感力) | gf | 70±10 | |
| RF(回弹力) | gf | 15 | Min. |

11. Packaging 包装

Packaging type: Tray, 1000Pcs/Tray, 4000Pcs/Carton.

包装方式: Tray 盘,1000Pcs/盘, 4000Pcs/箱.

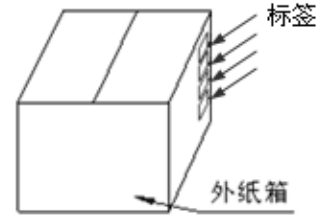
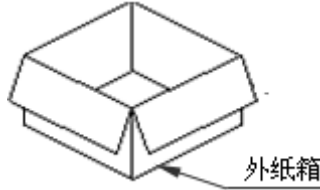

12. Precaution 注意事项

12.1 Immersion Soldering condition 浸焊条件

| ITEM 项目 | CONDITION 条件 |
|-------------------------------|---|
| Preheat temperature 预热温度 | 110°C Max (Ambient temperature of soldering surface of P.W.B) 110°C 以下(印刷基板焊锡面周围的温度) |
| Preheat time 预热时间 | 60s, Max 60 秒以内 |
| Area of flux 助焊剂面积 | 1/2 Max of PWB Thickness 印刷基板厚度的 1/2 以内 |
| Temperature of solder 焊锡温度 | 260±5°C 260±5°C |
| Time of immersion 浸焊时间 | 3s±0.5s 3s±0.5s |
| Number of soldering 焊接次数 | 2time Max (But should down heat of the first soldering) 2 次以内 |
| Printed wiring board 印刷基板 | Single side copper-clad laminates 单面铜箔 |

- (1) After switches were soldered, please be careful not to clean switches with solvent
开关浸焊后,注意不要用溶剂清洗.
- (2) Under the condition of using soldering iron, soldering temperature shall be 350°C±5°C with 3±0.5s.
在使用烙铁的情况下,焊锡温度应在350°C±5°C,焊接时间3±0.5秒.

12.2 Notes 注意点

- (1) Please be cautious not to give excessive static load or shock to switches.
注意不要施加超负荷的压力或晃动开关.
- (2) Please be careful not to stack up P. W. B. after switches were soldered.
开关焊接以后,印刷基板注意不要叠放.
- (3) Preservation under high temperature and high humidity or corrosive gas should be avoided
Especially. When you need to preserve for a long period, do not open the carton.
保管时尤其应注意避开高湿高温和有腐蚀性气体的环境.如需长时间保存,请不要打开包装箱.
- (4) Products meet the ROHS & REACH environmental management substances control standards
产品满足 ROHS & REACH 环境管理物质管制标准