

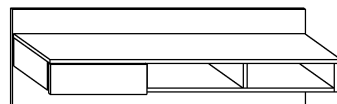

UNO - BIURKO

► 121 ▲ 40 ▼ 40



x 18

(a)

x 6

(b)

x 12

(c)

x 12

(d)

x 2

(f)

x 4
(3,5x30)

(g)

x 12
(3,5x16)

(h)

x 10

(i)

x 1

(j)

30 min

x 1 kpl. (350 mm)

(e)

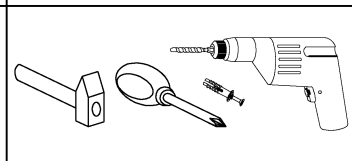
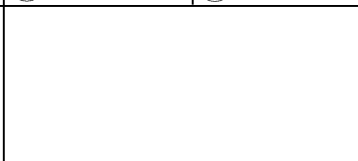

1 - FAZY MONTAŻU **A** - OZNACZENIE ELEMENTÓW **a** - OZNACZENIE AKCESORIÓW

1

x 2 (b)

x 4 (c)

x 1 kpl. (e)

x 8 (3,5x16) (h)

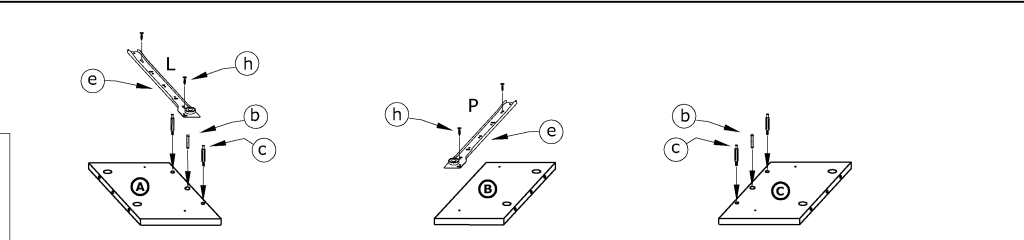

2

x 4 (b)

x 8 (c)

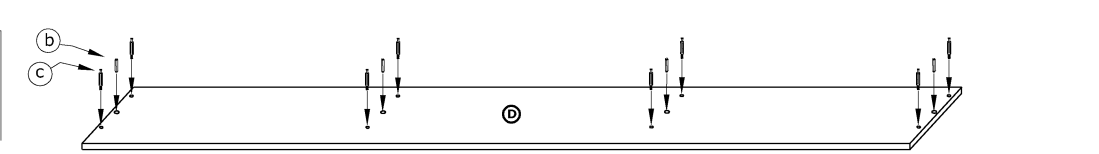

3

x 4 (a)





4

x 4 (d)



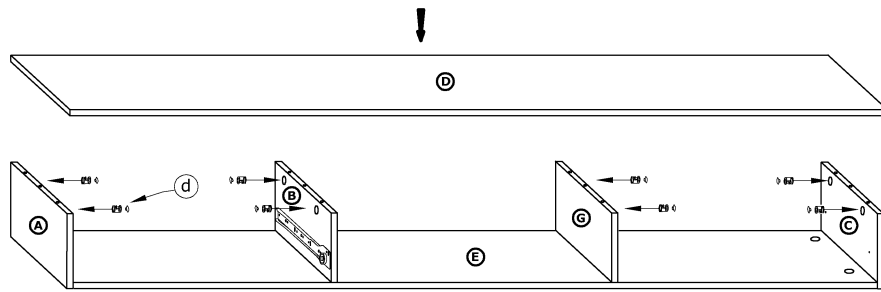

5 x 8

 d

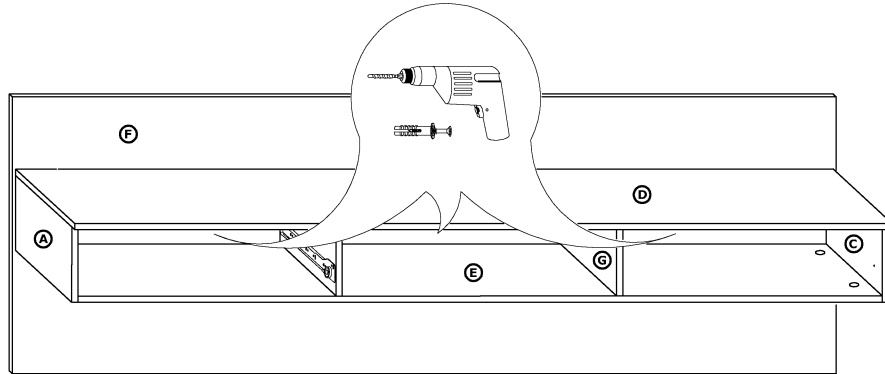
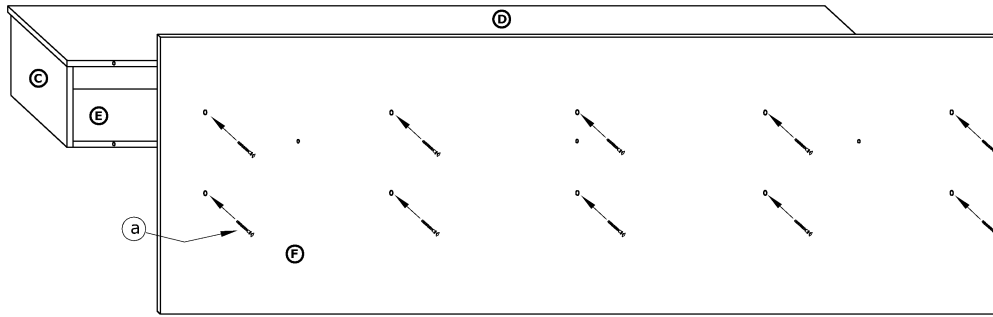



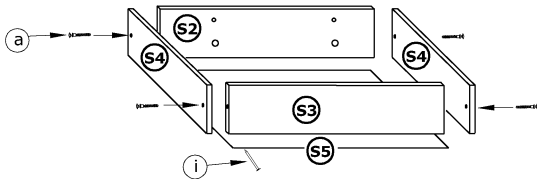

6 x 10

 a

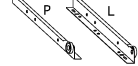

7 x 4 x 10
 
 a i

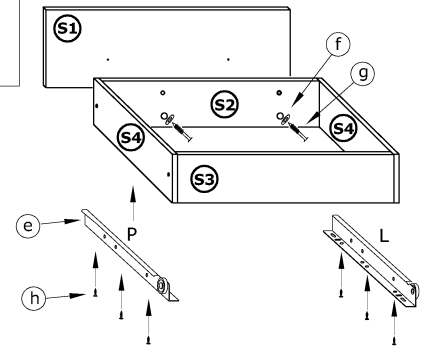

8 x 1 kpl. x 2
 
 e f
 x 2 x 6
 (3,5x30) (3,5x16)
 
 g h

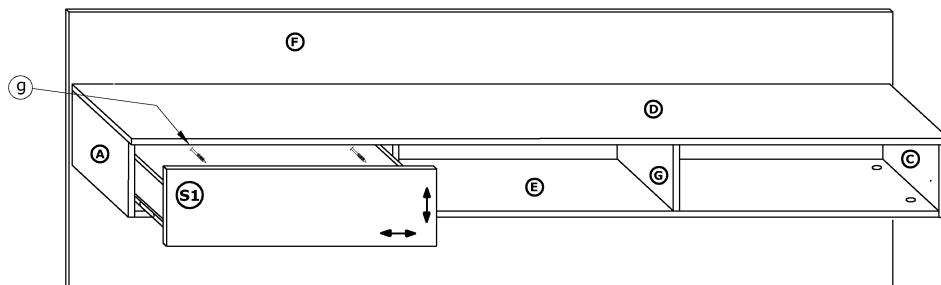

9 x 2
 (3,5x30)

 g



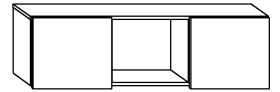

UNO - SZAFKA WISZĄCA

► 120 ▲ 36 ▼ 30



x 8

(a)

x 4

(b)

x 8

(c)

x 8

(d)

x 4

(e)

x 4

(f)

30 min

x 2 kpl.

(g)

x 4
(6,2x13)

(h)

x 8
(3,5x16)

(i)

x 40

(j)

x 1

(k)

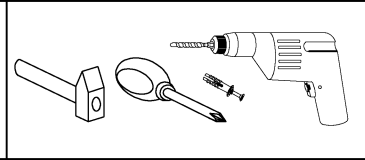

① - FAZY MONTAŻU

Ⓐ - OZNACZENIE ELEMENTÓW

Ⓐ - OZNACZENIE AKCESORIÓW

①

x 2 (b) x 4 (c)

x 4 (e)

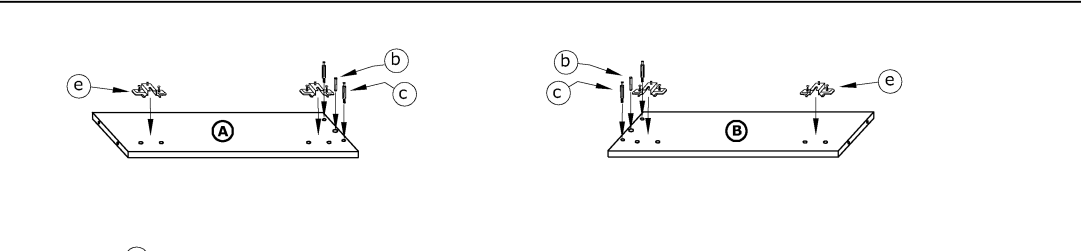

②

x 2 (g) x 4 (h) (6,2x13)

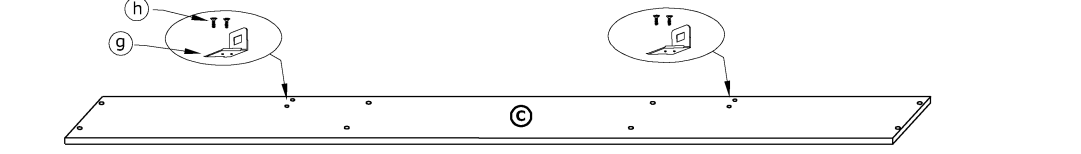

③

x 2 (b) x 4 (c)

x 4 (d)

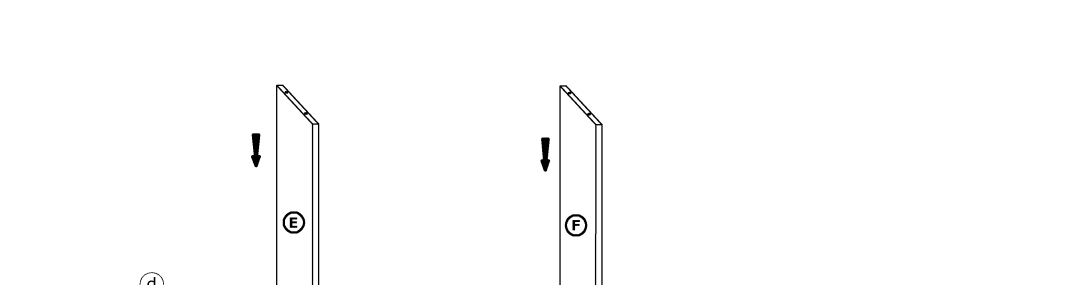

④

x 4 (d)

