

**ECOJOHN<sup>®</sup>**

# SR Series

Waterless Incinerating Toilet



**ECOJOHN**

17282 Mt Wynne Circle • Fountain Valley • CA 92708  
Phone: 1.866.ECOJOHN • 714.568.1077 • Fax: 714.568.1068  
www.ECOJOHN.com • info@ECOJOHN.com

# SR Series Waterless Incinerating Toilet



## Introduction

The SR models are self-contained waterless toilets that use an ingenious incineration process to reduce waste into sterile ash. These “green” toilets are extremely efficient and they are very easy to operate and maintain. Since they require absolutely no water, these toilets help to save 1000's of gallons of our earth's precious water every year.

The SR toilets are perfect for areas where plumbing connections or sewage systems are not available. The aestatically pleasing design along with outstanding efficiency, have made them a very popular solution/alternative to today's expensive septic tanks.

The SR Series consist of two sizes: SR5 and SR12. In addition to different physical sizes, they also differ in colors, capacity, and what type of fuel they use. The SR5 models use propane and are our smallest models (capacity wise) that are ideal where the usage is small. SR12 models are built to handle a higher capacity environment and are available in propane, natural gas, and diesel.

# How the toilet works

The requirements for the toilets to operate are a power source and propane, natural gas, or diesel. They conveniently attach to 120/240V AC power, or 12V DC which can be recharged by solar power.

To operate the toilet one simply has to add a toilet liner to the bowl before waste flush (optional). After usage, one can rinse a little bit of water mixed with Royal Mist liquid (optional) before closing the lid and press one of the two flush buttons (urine or waste).

An auger will then feed the paper liner and waste into the burn chamber and shortly thereafter the burner automatically commences and the burn cycle is underway.

Since these models burn all the waste after each usage, there will never be any waste left inside the toilet that can cause unpleasant odor.

Depending on the SR model used, the process can take a few minutes for a quick urine cycle, or up to 30 minutes for a waste cycle. One of the great features of these units is that even though a burn cycle is in progress, one can still use the toilet. It will simply shut off the burning process when the toilet lid is lifted up. Once the lid has been closed again, it will resume the burn process and finish the burn cycle.

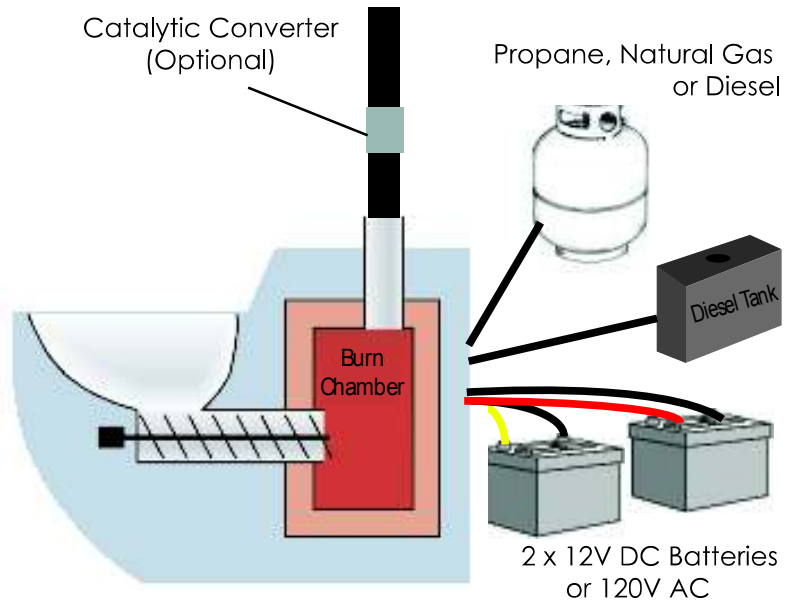

## Electrical Control Box



## Clean Out Access Door



## Bowl Liner Instructions

Use a bowl liner for each waste use

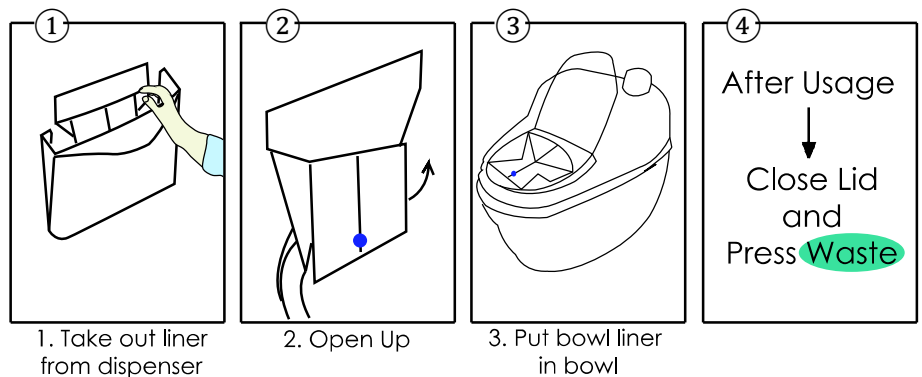

# SR Models

MODELS	FUEL	POWER	CAPACITY
SR5	Propane	12V DC / 120V AC / 240V AC	4-5 people
SR12	Propane	120V / 240V AC	8-10 people
	Natural Gas	120V / 240V AC	8-10 people
	Diesel	12V DC / 120V / 240V AC	8-12 people

## Operation

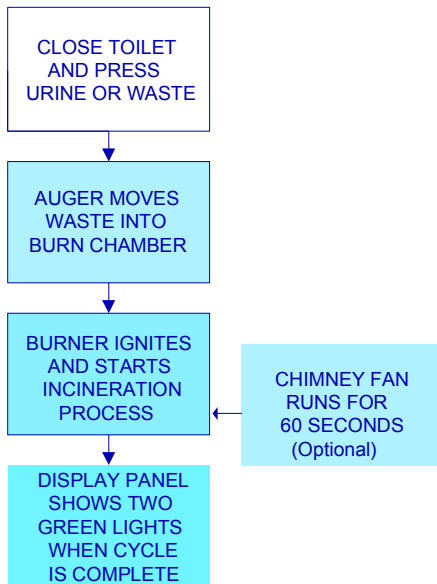

## SR12



The SR12 is made to handle higher capacity and a tougher environment than the SR5. Its steel enclosure is available in white, grey metallic, or black.

## Display Panel



A control board monitors the amount of usages and its burn process. Indication lights come onto a display panel if there is an error or if the process has finished its burn cycles. The panel also has the two flush buttons that one has to push in order to start the burn cycle.

## Maintenance / Cleaning

For regular usage, the toilet only has to be emptied periodically (depending on usage). The chamber is easily accessible through a lid located in the back of the toilet, and it makes the ash removal process easy. To ensure a clean bowl and auger, the toilet is equipped with a small reservoir of water, which can be used to clean the bowl. One only needs to press a rinse button to rinse the bowl. As an option, it is also possible to add a liner in the bowl before usage; the liner gets moved into the burn chamber along with other waste material. Once inside the chamber, the incineration process quickly eliminates the paper liner along with the waste.

## Safety & Emission

The toilet is a safe and convenient appliance when assembled and used properly. In order to provide a high quality toilet, we have chosen high quality materials that are made to withstand high usage and a severe environment. Throughout the production, it goes through several meticulous testing procedures, which has been approved by Underwriters Laboratory (UL) and CE. Also, the toilet is equipped with multiple safety devices that recognize if any minor problems occur and shut off the unit. The toilets are equipped with very efficient burners that ensure reliability in operation and low emission.



UL and CE approved.

# Installation

The installation process is easy and can be done in a few simple steps. It is important that the unit gets installed in a weather proof building so it doesn't get exposed to snow or rain. A minimum of 5 inches clearance from any wall is recommended.

The toilet includes an 8 ft chimney system (6" double wall pipe - 6" I.D, 8" O.D). It can go vertically or horizontally out through the roof/wall. When the chimney system has been installed, the next step is to connect the power supply and fuel (Propane, Natural Gas, or Diesel). The toilets can operate with a small BBQ propane tank or larger propane sources. The SR12 also operates with diesel or kerosene.

Since these are waterless incinerating toilets, they operate in very extreme climates (hot or cold). No compost or chemicals are required.

## Included in Chimney System

- 8 ft Chimney Pipe
- Flashing
- Storm Collar
- Roof Support
- Firestop
- Chimney Cap
- ECOJOHN Adapter



## Chimney Installation Options

Type A

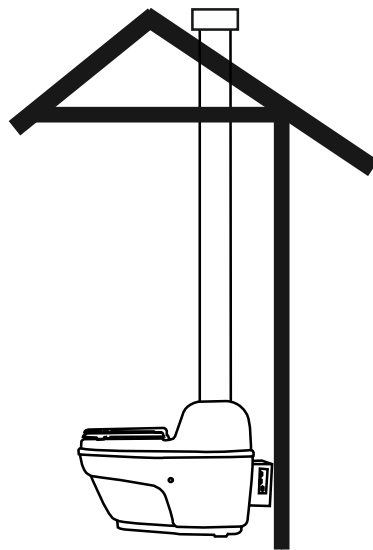

Type B

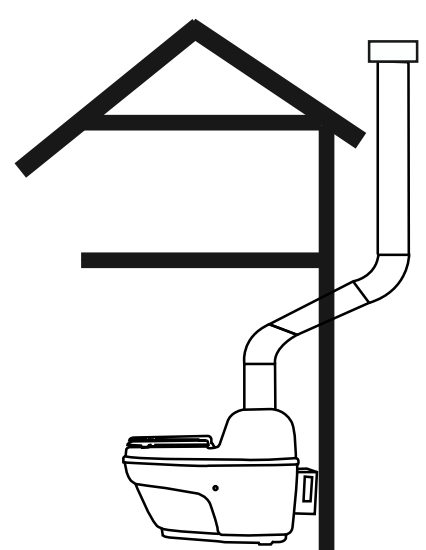

Depending on the installation, some optional parts may be required:

- Catalytic converter



a catalytic converter may be installed in the chimney pipe; the catalytic converter cleans the outgoing air and ensures that there are no harmful agents going out.

- Royal Mist liquid



a special liquid that can be added to the water reservoir - the Royal Mist takes out any bad odor (if any).

- Solar system



can be installed with 12VDC batteries to ensure fully charged batteries

- Chimney fan

an extra fan may be installed in areas where extra draft is needed.

TECHNICAL DATA	SR5	SR12	SR12
Fuel	Propane	Propane, Natural Gas	Diesel
Hourly Btu Input	18,000 btu/hr	50,000 btu/hr	70,000 btu/hr
Operating Voltage	12V DC, 120V AC, 240V AC		
Temperature	Storage: -40 to 140° F Operation: -35 to 140° F		
<b>DIMENSIONS</b>			
Height	28"	32"	44"
Width	23"	25"	25"
Depth	38"	39"	42"
Sitting Depth	19"	20"	21"
Weight	132 lbs	220 lbs	250 lbs
Capacity	4-5 People	8-10 People	8-12 People
Electrical Load	12V DC: 1.5 Amp 120V AC: 0.15 Amp	12V DC: 11-12 Amp 120V AC: 3-4 Amp	12V DC: 11-12 Amp 120V AC: 3-4 Amp
Propane Consumption	Urine Cycle: 0.14 lbs Waste Cycle: 0.35 lbs	Urine Cycle: 0.14 lbs Waste Cycle: 0.35 lbs	
Natural Gas Consumption		Urine Cycle: 0.04 therm Waste Cycle: 0.1 therm	
Diesel Consumption			Urine Cycle: 0.03 gal Waste Cycle: 0.08 gal

SR5 2 Dimensional

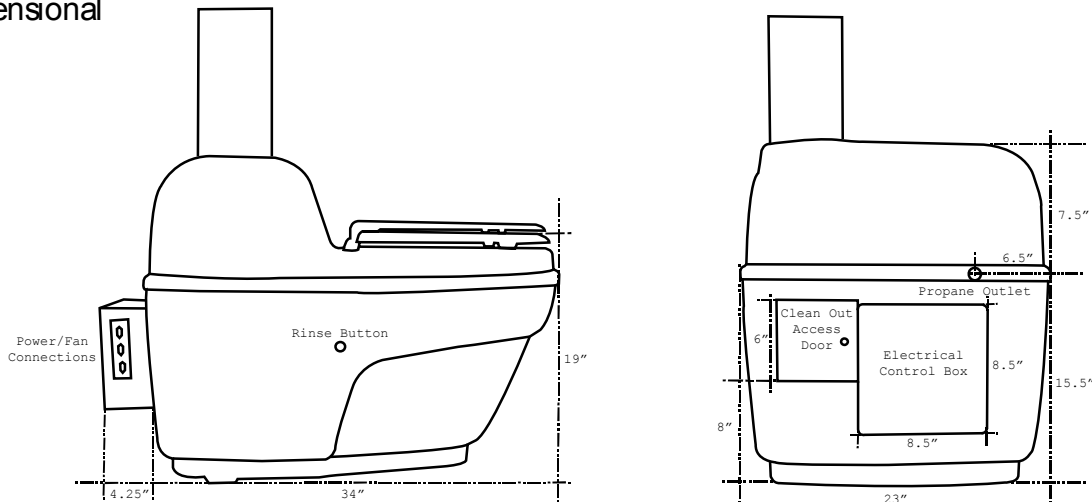

SR12 2 Dimensional

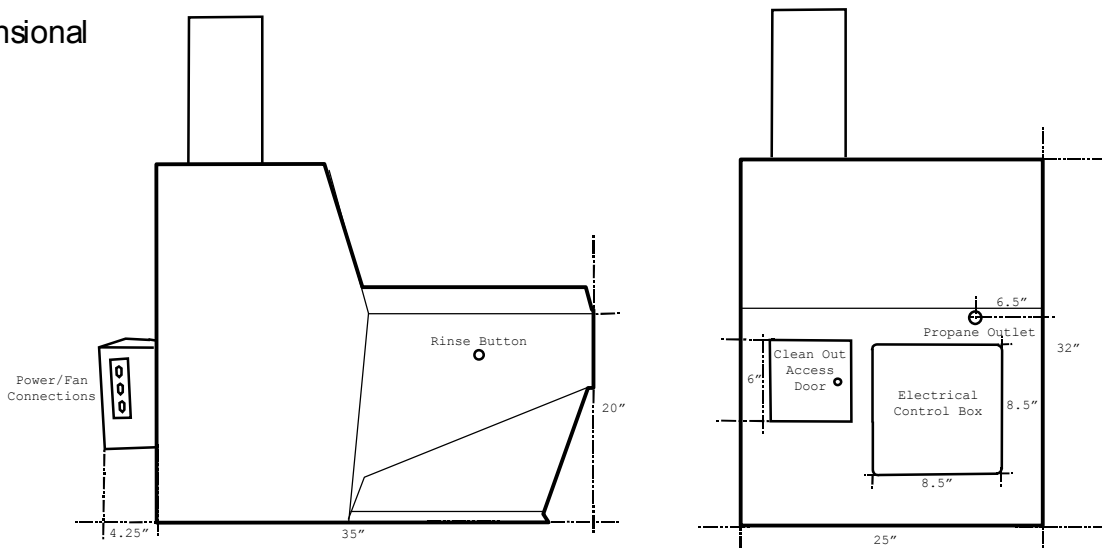

# Applications

Construction Sites / Mining Sites / Military Camps / Disaster Situations  
Exploration Camps / Oil Platforms / Ships, Boats, Barges / Cabins





[www.ECOJOHN.com](http://www.ECOJOHN.com)  
[info@ECOJOHN.com](mailto:info@ECOJOHN.com)

ECOJOHN  
17282 Mount Wynne Circle  
Fountain Valley, CA 92708  
P: 1.866.ECOJOHN  
F: 714.568.1068