

FIRE PIT

ASSEMBLY & INSTALLATION INSTRUCTIONS



This manual contains instructions for the safe installation and use of the fire pit.
Before installing and using your appliance, read the entire manual and follow the instructions and warnings carefully.

FIRE PIT

STANDARD EQUIPMENT RECEIVED

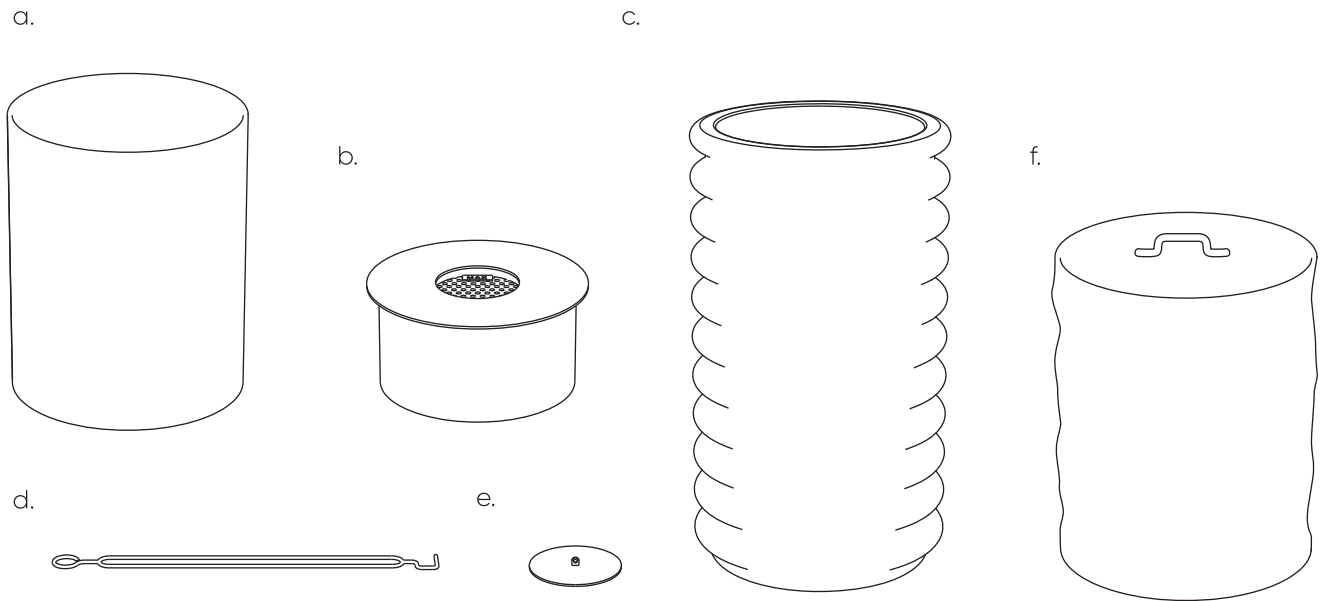

- a. 5mm thick glass cylinder
- b. 304 stainless steel burner
- c. Concrete base
- d. Lid picker
- e. Lid
- f. Polyester cover

IMPORTANT SAFETY INFORMATION

WARNING

1. EXPLOSION/FIRE HAZARD

- (1) Never use any fuel other than Bioethanol in the appliance. Never use gasoline.
- (2) Shut appliance off and allow to cool 60 minutes before refueling. Flame may be difficult to see – do not assume appliance is off. Always follow shut-off procedure before refueling.
- (3) Wipe up spills immediately with a dry cloth followed by a cloth dampened with water. Allow to dry completely before lighting Burner.
- (4) Do not operate in a room with oxygen tanks in use or if flammable vapors are present.
- (5) Never smoke while refueling or lighting the appliance.

2. LOCATING THE FIRE

- (1) Keep children away from the appliance. Never leave children unsupervised when the fire is operating.
- (2) For decorative purposes only. Not suitable for continuous operation. Do not use the appliance to heat or boil water or as a cooking appliance. Do not put wood, charcoal, paper or other combustible objects in the Fire.
- (3) Do not move or relocate the appliance while in use.

3. VENTILATION

- (1) Open fires consume oxygen and contain the risk of indoor air pollution. Use only in well-ventilated areas and those that are protected from the draft effects of cross ventilation. Improper ventilation can cause serious injury or death. People with breathing problems should consult a physician before using the appliance.

4. OPERATING THE FIRE

- (1) This appliance ONLY uses Bioethanol fuel.
- (2) Louis Osier is not liable for any damage caused by using the incorrect type of fuel.



**DO NOT FILL
WHILE BURNING**



**DO NOT FILL
WHILE HOT**



**DO NOT TOUCH
WHILE HOT**

- (3) Risk of explosion or burn. Use only the lighting rod. Using matches or other lighters could result in serious injury.
- (4) Remove the Burner frequently to check for any residual fuel underneath the Burner. Accumulation of fuel underneath could cause an explosion.
- (5) NEVER leave a fire unguarded.
- (6) For those models that come with a Glass cylinder:
WARNING: DO NOT OPERATE WITHOUT THE GLASS CYLINDER
The appliance must be fully assembled before being operated.
Failure to install (or removal of) glass cylinder will void the warranty and render the product unapproved for use with the included burner.

6. HOT SURFACE HAZARD

- (1) Due to high surface temperatures, keep children, pets, clothing and furniture away from the unit, as the unit is hot while in operation, contact with the appliance may cause skin burns.
- (2) The shut-off mechanism on the Burners will become very hot during operation and will stay hot for up to 60 minutes after use. To avoid injury, do not touch with any parts of your body nor with any combustible materials such as matches or flammable liquids. Always use the lighting rod provided with your appliance to open or close the shut-off mechanism.

INSTALLATION & EXTINGUISHMENT

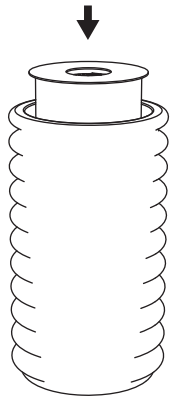

STEP 1

Insert the steel burner into the concrete base.

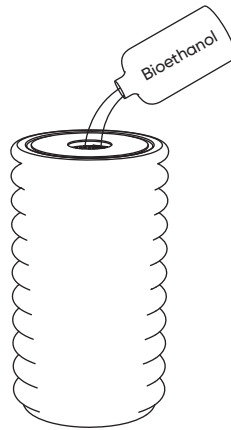

STEP 2

Carefully pour ethanol into the central opening of the burner.
(3 liters can last 4 hours)

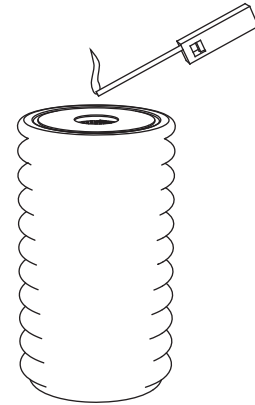

STEP 3

Light the fire with a lighter rod.

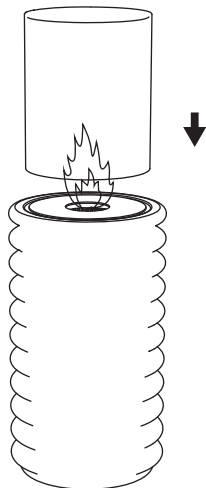

STEP 4

Carefully place the glass cover on the base.

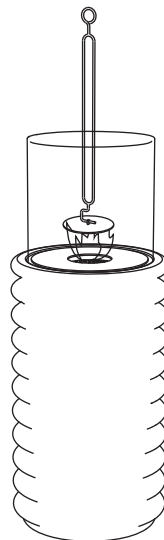

STEP 5

Use the lid picker and lid to extinguish fire.

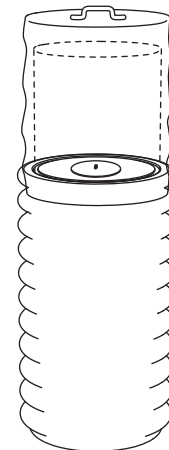

STEP 6

Keep it cover when not in use.

WARRANTY & CARING

LENTH OF WARRANTY

FIVE YEAR WARRANTY FROM DATE OF PURCHASE ON STAINLESS STEEL BURNER.

Chips and scratches are not covered by warranty. Natural variation in colour, texture and porosity may occur with Concrete base. Technology products and are considered inherent and valued qualities of the material. Non-structural hairline cracks are possible and shall not be considered a manufacturing defect.

If there is any question about the fire pit, please contact us

Email: HELLO@LOUISOSIER.COM

OFFICE: 415.324.7064

CARING FOR YOUR FIRE PIT

Do not put HOT burner lids down on the concrete surfaces. It could damage the model.

Maintenance and cleaning must only be performed when the Burner is OFF, COMPLETELY EMPTY & DRY and at ROOM TEMPERATURE.

1. To finish cleaning use a damp disposable cloth and wipe until no dust remains.
2. Use the cover to avoid rain gets into the burner, damp condition might cause difficult to fire