

# READY, SET, PRO

USER MANUAL

FLEXSTRIDE BIKE



Aerobic exercise has enormous benefits for your body, brain, and mental health.

At least 75 minutes of vigorous aerobic exercise such as cycling, are recommended each week for optimal health.

## HELLO THERE.

Joel and I are athletes who suffered from severe ACL injuries a few months apart. We purchased multiple pieces of exercise equipment for our in-home rehab but were left disappointed and frustrated by fitness gear that made big promises but gave no support, no well-thought-out plan to follow, and no results. And that's how Lifepro came about, and why the Recovery + Fitness active recovery collection was created — we've set out to change all of that. It's why every piece of equipment bearing our name not only undergoes rigorous scrutiny to make sure it delivers on power and efficacy, but also comes with built-in support from our 'guiding angels' and a built-in lifetime warranty so that you're never left hanging.

Welcome to Lifepro.  
We're in this together now.

*Abe & Joel*



Not everyone can afford to hire a personal trainer or a team of professionals to help them feel and look their best. But the good news is: you don't have to. Lifepro brings the gym to you.

With the Lifepro FlexStride Bike, you can build cardiovascular fitness and muscle strength from the comfort of your home or office. Use the FlexStride while sitting on the couch watching TV, while reading a book, or while sitting in a chair. The FlexStride is small and portable enough to take with you to work and fits right under your desk!

The FlexStride improves blood circulation, muscle tone, and flexibility. Eight pedal resistance levels allow you to create custom cycling workouts. On the lowest resistance level, workouts would be equivalent to a leisurely bike ride in the park. Increasing the pedal resistance allows you to create more intense workouts, similar to biking up a steep hill. Just sit back, relax, and let your legs do the work! See results in just 15–20 minutes a day.

## Redefine your workouts and experience the transformative power of the Lifepro FlexStride:

- **Increase strength & flexibility:** improves stability and muscle tone
- **Regulate weight:** boost your heart rate and burn calories.
- **Decrease chronic pain:** improves core strength & circulation
- **Boost your metabolism:** encourages your body to burn fat faster
- **Decrease your stress:** increases serotonin and decreases cortisol
- **Lower blood pressure:** improves circulation
- **Develop stronger bones:** increases bone density

Check out the exercises in this manual for ways to get started using your FlexStride. Next, be sure to visit our website [flexstride.lifeprofitness.com](https://flexstride.lifeprofitness.com) for access to our **FREE library of workout videos** which demonstrate how to easily incorporate the FlexStride into your fitness routine.

# FLEXSTRIDE

BIKE

## GET STARTED

### WHAT'S IN THE BOX

- Lifepro FlexStride Bike
- Interchangeable Pedals (2)
- Wheel Stoppers (2)
- User Guide
- AAA Batteries (2)
- Wrench
- Hardware
  - M8 Bolts (4)
  - D8 Flat Washers (4)
  - M8 Nylon Lock Nuts (4)
  - Adhesive Foam Pads (4)

### FIRST STEPS

1. Remove your FlexStride from the shipping box and remove all packaging from the unit, parts, and hardware.
2. Read carefully through this user manual and all safety instructions before assembling and using the FlexStride.
3. Go to [flexstride.lifeprofitness.com](https://flexstride.lifeprofitness.com) and register your product within 14 days of purchase to activate your lifetime warranty.
4. Complete the steps in the 5-MINUTE ASSEMBLY GUIDE on page 8 to begin using your FlexStride.

### CUSTOMER SUPPORT

If you have any questions about setting up your FlexStride, we're here to help. Call or email us and an experienced customer support representative will be happy to assist you: (732) 456-6063 or [support@lifeprofitness.com](mailto:support@lifeprofitness.com).

## GET ACQUAINTED



Pedals (2)



Lifepro FlexStride Bike

Wheel Stoppers (2)



Wrench



### Hardware

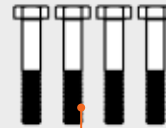

M8 Bolts (4)



D8 Flat Washers (4)



Nylon Lock Nuts (4)







Adhesive Foam Pads (4)

## 5-MINUTE ASSEMBLY GUIDE

### ASSEMBLY NOTES

- Assemble the FlexStride on a flat, sturdy floor, covered by a mat or cloth to protect your carpet or flooring.
- Ensure the space is free of obstructions.

### HARDWARE

- |   |   |                         |
|---|---|-------------------------|
| 1 |  | M8 Bolts (x4)           |
| 2 |  | D8 Flat Washers (x4)    |
| 3 |  | M8 Nylon Lock Nuts (x4) |
| 4 |  | Foam Pads (x4)          |
| 5 |  | Wrench (x1)             |

### ATTACH THE PEDALS

1. Align the left pedal (6L) with the screw holes in the left pedal arm (7).
2. Insert two bolts (1) through the top of the pedal and through the pedal arm.
3. Put a washer (2) onto the end of each bolt.
4. Screw a nylon lock nut (3) onto the end of each bolt.
5. Use the wrench (5) to tighten the two nuts, securing the pedal to the bike. Make the nuts as tight as you can.
6. Remove the adhesive backing from the two foam pads (4) and firmly stick one to each bolt head.
7. Align the right pedal (6R) with the screw holes in the right pedal arm (8).
8. Repeat steps 2-6 to secure the right pedal to the bike.

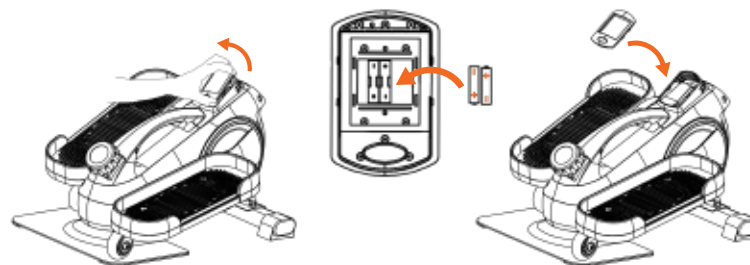
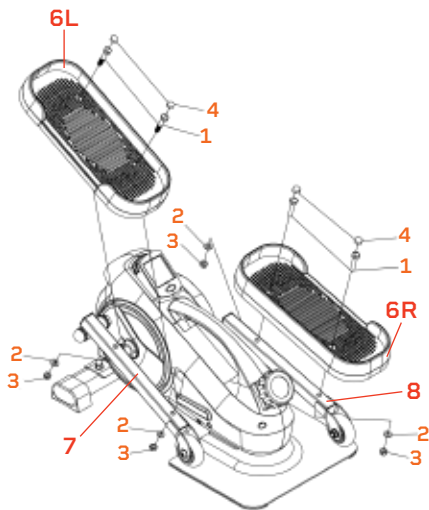

### INSERT BATTERIES INTO THE MONITOR

1. Remove the monitor by carefully pulling it out from the top edge.
2. Insert two AAA batteries into the battery receptacle. Ensure they are oriented correctly.
3. Carefully tuck the wires back in as you re-insert the monitor. Insert from the bottom first, then press in the top of the monitor.

### INSTALL A FITNESS APP TO MANAGE YOUR WORKOUTS

1. Scan the QR code below for a list of compatible fitness apps.

**NOTE:** If you do not already have a QR Code Scan app, you may need to download one first. Many newer phones have a QR code scanning feature built into the camera app.

2. Download your preferred fitness app.
3. On your phone, go to **Settings > Bluetooth**, to turn on Bluetooth.
4. In the Bluetooth device list, connect to your FlexStride.
5. Open the app and create an account.
6. Now, you can create a personalized exercise plan in the app. You can follow structured biking workouts, including cycling routes around the world. Track calories burned, your speed, workout duration, and all of your workout activity information. Create training goals, complete fitness challenges, and more.



**lifepro**

*Apps are not affiliated with Lifepro. Some features may require in-app purchase.*

## PARTS OF THE FLEXSTRIDE

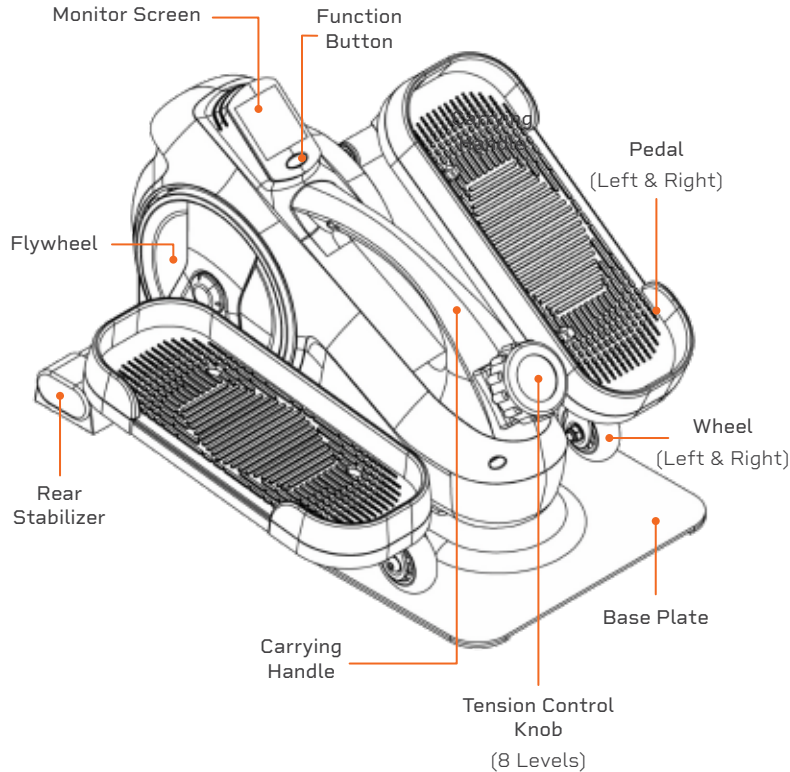

## OPERATING INSTRUCTIONS

### CREATE A CUSTOM CYCLING WORKOUT

Create a custom aerobic workout with your desired speed, intensity, and duration:

1. Adjust the pedal tension (see below) to your desired resistance level.
2. Place your feet flat on the pedals.
3. Begin pedaling, forwards or backwards, at your desired speed. You can check your speed on the monitor. Speed is displayed in RPMs (rotations/strides per minute).
4. Keep an eye on the monitor to track your workout duration.

### ADJUSTING THE PEDAL RESISTANCE/TENSION

The FlexStride has eight levels of resistance (1-8). Level 1 is the lowest resistance level and provides the easiest pedaling. Level 8 is the highest resistance level and provides the most intense pedaling workout.

1. Turn the Tension Control Knob to the right or left to adjust the resistance level. Align the arrow on the knob to the tension level you would like to select.
2. Turn the knob to the right to increase the resistance level. Turn the knob to the left to decrease the resistance level.

### USING THE BIKE WITH A WHEELED OFFICE CHAIR

While using the bike with a wheeled office chair, use the included wheel stoppers to prevent the chair from moving backwards when pedaling. To use the wheel stoppers:

1. Place the wheel stoppers on the floor, with the notched-side facing up.
2. Insert the chair's front wheels into the notches of the stoppers.
3. Position the bike in front of the chair.
4. Sit in the chair and begin pedaling. Your feet should easily reach the pedals while sitting in the chair. Your knees should be slightly bent when the pedals are furthest from you.

## THE FLEXSTRIDE MONITOR

FUNCTION	INFORMATION DISPLAYED ON MONITOR	VALUE
RPM	Displays the current workout speed in strides/minute	0 - 999 Strides/Min
SCAN	Displays each function in turn: time, cnt, dist, cal, t-cnt	Varies
TIME	Displays the duration of the current workout	00:00 - 99:59 (Min:Sec)
CNT	Displays the number of strides in the current workout	0 - 9999 Strides
DIST	Displays the current distance traveled	0 - 999.9 Miles
CAL	Displays the calories expended during the current workout	0.0 - 999 KCAL
T-CNT	Displays the total number of strides (across all workouts)	0 - 9999 Strides Total
BATTERY	Displays only if the batteries need to be changed	N/A

### CHANGE MONITOR DISPLAY

The top line of the monitor shows your current workout speed in RPM (strides per minute). The bottom line shows the selected function. To adjust the function displayed on your monitor:

1. Press the blue Function button to toggle through the available display functions: scan, time, count, distance, calories, and total count.
2. The small black arrow at the bottom of the screen shows which function is currently selected.

### RESET ALL VALUES

To reset all of the workout values (time, count, distance, calories, etc.):

- Press and hold the Function button for four seconds to reset all values, **OR**
- Replace the monitor batteries.

### AUTO SHUTOFF

The monitor will automatically shut off after four minutes of inactivity. The monitor will auto power on when you press the Function button or begin to exercise.



## TIPS FOR USING YOUR FLEXSTRIDE

### HOW TO PEDAL

1. Start pushing downward on the pedal when the pedal arm is at its highest position.
2. Stop pedaling when the pedal is at its lowest position.
3. Make sure to press downward with your feet while you are pedaling.

### START SLOW & LISTEN TO YOUR BODY!

It is important to start slow to avoid injury.

1. Begin your cycling workout on the lowest resistance, level 1. If you do not often ride a bike, beginning at the lowest level gives your muscles a chance to get used to cycling.
2. Increase the resistance, as well as your speed and workout duration, as you get used to the FlexStride.

### KEEP YOUR UPPER BODY STILL

Pedaling is easier when you keep your upper body still.

1. Use your legs to pedal, not your body.
2. Your head and upper body should not move while you are pedaling.
3. Don't rock from side to side.
4. It is easier to keep your body still if you pedal downward by pressing your feet downward—rather than forward—on the pedals.

### SAFETY TIPS

- Place the FlexStride on a sturdy, level, non-slip surface, with at least 12 inches of clearance on all sides. Place a mat or rug under the FlexStride to protect your carpet or flooring.
- Stop exercising immediately if you feel dizzy, lightheaded, or nauseous, or if you experience pain, tightness in your chest, irregular heartbeat, or extreme shortness of breath.
- Drink plenty of water before and after exercise.
- Do not sit or stand on the FlexStride; the maximum weight capacity is 110 lbs per pedal.
- Do not place your fingers or toes under the pedals or wheels.
- Do not use on a full stomach.



# WHERE TO USE THE FLEXSTRIDE



**ON THE COUCH**



**AT WORK**



**IN A CHAIR**



**LIFETIME  
WARRANTY**

Lifepro Fitness creates quality, durable exercise products and we stand by that quality with a lifetime warranty on all of our products. If your FlexStride ever breaks (and we doubt it will), we'll send you replacement parts and show you how to repair it. If your FlexStride cannot be repaired, we'll replace it—free of charge. Register your FlexStride at [flexstride.lifeprofitness.com](https://flexstride.lifeprofitness.com) to activate your warranty within 14 days of purchase.



# EXERCISE INSTRUCTIONS

Using your FlexStride will improve your physical fitness, tone your muscles, and when combined with a calorie-controlled diet, it will help you lose weight.

**PRO TIP:** Change up your workout duration, speed, as well as your exertion level and heart rate to keep improving your fitness and mobility.

## STEP 1: WARM UP PHASE

Spend about 5 minutes warming up. Doing warm up stretches before exercising prevents pulled muscles and other exercise injuries. Stretching gets blood flowing and helps loosen your muscles so they are ready for exercise. While doing the following stretches, do not force or jerk your muscles, and most important, if it hurts: STOP.

### TOUCH YOUR TOES

1. Bend your knees slightly.
2. Let your back and shoulders relax as you bend over and try to touch your toes.
3. Hold the stretch for 10-15 seconds.
4. Repeat 3 times.



### STRETCH YOUR CALVES AND FEET

1. Sit on the floor or a cushion.
2. Place your left foot against your right inner thigh.
3. Bend toward your right foot and try to touch your toes.
4. Hold the stretch for 10-15 seconds
5. Switch legs and repeat. Stretch each leg 3 times.



### STRETCH YOUR QUADS

1. Place your left hand on a wall or a table to help with your balance.
2. With your right hand, grab your right ankle.
3. Pull your heel in toward your buttocks.
4. Hold the stretch for 10-15 seconds
5. Switch legs and repeat. Stretch each leg 3 times.



### STRETCH YOUR GROIN

1. Sit on the floor or a cushion with your knees bent and the soles of your feet together.
2. Hold your ankles and bend forward at your hips.
3. Hold the stretch for 10-15 seconds
4. Repeat 3 times.



## STEP 2: EXERCISE PHASE

During the exercise phase you're building muscle, stamina, and improving your cardiovascular health. It's important to begin slowly and increase your workout duration, intensity, and the resistance level of the pedals slowly over time. Work at your own pace and be sure to maintain a steady tempo throughout. The intensity of your workout should be sufficient to raise your heartbeat into the target zone shown on the graph below.

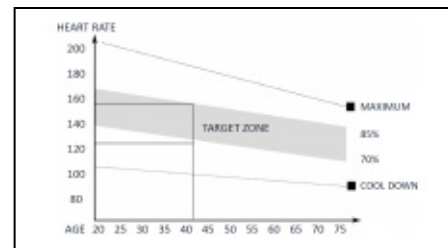

Calculate your personal target heart rate when exercising based on your fitness goals.

**MAXIMUM HEART RATE**  $220 - \text{Your Age} = \text{Max Heart Rate}$

This value represents your maximum heart rate and serves as a basis from which to calculate your personal training heart rate.

**HEALTH & WELLNESS**  $\text{Target Zone} = 50\text{-}60\% \text{ of Max Heart Rate}$

Ideal for people who are overweight, older, beginners, and/or who do not exercise regularly.

**FAT BURNING**  $\text{Target Zone} = 60\text{-}70\% \text{ of Max Heart Rate}$

Ideal for athletes and sports people who aim to lose weight.

**CONDITIONING & FITNESS**  $\text{Target Zone} = 70\text{-}80\% \text{ of Max Heart Rate}$

Ideal for athletes and sports people who want to improve their stamina and/or conditioning.

**For optimal training results, calculate the average value of selected target zone (also see chart above):**

- **Health & Wellness:** target zone average = 55% of max heart rate (max heart rate  $\times$  0.55)
- **Fat Burning:** target zone average = 65% of max heart rate (max heart rate  $\times$  0.65)
- **Conditioning & Fitness:** target zone average = 75% of max heart rate (max heart rate  $\times$  0.75)

## STEP 3: RECOVERY PHASE

After exercising, it's important to give your body time to cool down and recover. Spend 5 minutes completing the warm up stretches again to allow yourself time to cool down. Be careful not to force or jerk your muscles as you stretch.

# SAFETY

## PLEASE KEEP THIS MANUAL IN A SAFE PLACE FOR REFERENCE.

**WARNING:** To reduce the risk of burns, fire, electric shock, injury to persons, or damage to equipment, read the following important precautions and information before operating the FlexStride.

### DISCLAIMER

1. The health benefits suggested or implied in this manual, other product literature, and website are not certified or endorsed by any regulatory authority or medical institute.
2. The use of this hand massager is entirely at the user's discretion. Please read all instructions and safety information carefully before using this product. We assume no responsibility for personal injury or property damage sustained by or through using this product.

### RESPONSIBILITIES

3. **WARNING: To ensure the safety of users, always ensure all nuts and bolts are securely tightened before exercise.**
4. Always inspect the device for damage before each use. Do not use if damaged, worn, malfunctioning, or if the unit has been exposed to water. Do not use bike again until the problem has been fixed.
5. Use the FlexStride only as instructed in this manual.
6. It is the responsibility of the owner to ensure that all users of the FlexStride are adequately informed of all warnings and precautions.
7. Place the unit on a sturdy, level, non-slip surface, with at least 12 inches of clearance on all sides. Place a mat or rug under the FlexStride to protect your carpet or flooring. Ensure that the underlayment does not slide around before beginning exercise.
8. During assembly, it is recommended that you place parts and hardware on a mat to avoid soiling carpet or flooring.
9. Keep the FlexStride indoors, away from heat, moisture, and dust. Do not use outdoors. Keep away from open flame, explosive or flammable items, and heat sources.
10. Replace the batteries only with new AAA batteries.
11. Do not ingest the batteries. If the batteries have been ingested, seek medical help immediately, as this can cause internal burns or even death.
12. Dispose of the FlexStride, batteries, and all parts according to local regulations.

### DOS AND DON'TS

13. Keep children and pets away from the FlexStride at all times. For adult use only.

14. Adults with diminished mental or physical capacity may only use the FlexStride while supervised by a responsible adult.
15. Do not stand on the pedals. Only use the FlexStride in a seated position.
16. Do not exceed the maximum weight capacity of 110 lbs per pedal.
17. Do not allow more than one person to use the FlexStride at a time.

### EXERCISE SAFETY

18. Before starting any exercise program, consult with a medical professional to determine if you have any health conditions that could create a risk to your health and safety, or prevent you from using the FlexStride properly. Your doctor's advice is essential if you are taking medication that affects your heart rate, blood pressure, or cholesterol level.
19. Stop exercising immediately if you feel dizzy, lightheaded, or nauseous, or if you experience pain, tightness in your chest, irregular heartbeat, or extreme shortness of breath. If you experience any of these symptoms, consult your physician before continuing your exercise program.
20. Incorrect or excessive exercise can be damaging to health. Always exercise within the heart beat range and time limits recommended by your physician.
21. Always wear appropriate athletic clothing, socks, and athletic shoes when using the FlexStride. It is especially important to wear well-fitting shoes.
22. Do not wear loose or baggy clothing which may get caught in the equipment or restrict or prevent movement.
23. Do not use for more than 20 minutes at a time.
24. The FlexStride is intended for in-home use only. Do not use the FlexStride in any commercial, rental, institutional, or therapeutic setting.

### CLEANING & MAINTENANCE

25. Wipe down the FlexStride with a soft, damp cloth after each use. Do not use abrasive, solvent, or chemical cleaners or harsh detergents.
26. Store the device in a cool, dry location. Do not store in a garage or covered patio, or near water.
27. Remove batteries from the computer monitor if the FlexStride will not be used for a long time. Store the FlexStride and batteries in a cool, dry place.
28. Never remove the motor hood unless instructed to do so by an authorized service representative. Servicing other than the procedures in this manual should be performed by an authorized service representative only.
29. Never insert or drop any object into any opening.

## PRODUCT SPECIFICATIONS

### UNIT SPECS

Size: 22.7" x 18.5" x 12.9"

Net Weight: 26.5 lbs

Max User Weight: 110 lbs (per pedal)

Decibel Rating: <75 dB

Batteries Required for Monitor:

2 AAA batteries (included)

RECOVERY + FITNESS  
**FLEXSTRIDE**  
BIKE

MADE IN CHINA

### TROUBLESHOOTING GUIDE

Quickly troubleshoot simple issues you might experience using the table below. Please contact us for additional assistance at: [support@lifeprofitness.com](mailto:support@lifeprofitness.com), or (732) 456-6063.

<b>ISSUE</b>	<b>COMPUTER MONITOR DOES NOT WORK</b>
CAUSE	Batteries are installed incorrectly.
SOLUTION	Check to see if the batteries are installed in the correct direction.
CAUSE	Batteries are dead.
SOLUTION	Replace dead batteries with two new AAA batteries.
<b>ISSUE</b>	<b>THE PEDALS CAME LOOSE WHEN USING THE BIKE</b>
CAUSE	This can happen if the pedals were not properly tightened during assembly.
SOLUTION	Stop using the bike immediately and tighten the nuts securing the pedals.
<b>ISSUE</b>	<b>THERE IS A NOISE WHILE PEDALING</b>
CAUSE	The nuts attaching the pedals to the pedal mounts are not tight enough.
SOLUTION	Use the included wrench to tighten the nuts securing the pedals to the pedal arms as tightly as you can.
CAUSE	The nuts attaching the pedal arms to the bike frame are loose.
SOLUTION	Each pedal arm is attached to the bike frame with two nuts. Use the included wrench to tighten all the nuts. Be careful not to over-tighten.
<b>ISSUE</b>	<b>THE PEDAL WON'T STAY TIGHTENED OR ARE STRIPPED</b>
CAUSE	Using the bike with loose pedals will eventually damage the threads on the pedal arms. If caught early, tightening the nuts will solve the problem. If the threads are too damaged, the pedal won't stay tightened even after tightening the nuts.
SOLUTION	If the pedals are stripped, please contact us for assistance.

FROM OUR RECOVERY + FITNESS COLLECTION

## RHYTHM

VIBRATION PLATFORM

The Rhythm Vibration Platform works by creating rapid vibrations throughout the body, especially on the muscles specifically targeted. These vibrations cause the muscles to stretch, flex, and relax at a rapid rate. This results in increased muscle and bone growth, improved flexibility, and boosted metabolism—all of which increase the number of calories you burn.

The Rhythm can be used by people from every fitness level. If you have suffered an injury or you experience joint or back pain, find relief and help prevent future injuries by adding the Rhythm to your rehab routine.

### RHYTHM BENEFITS

- Improve mobility
- Prevent injury
- Increase strength
- Boost metabolism
- Improve sleep
- Develop stronger bones
- Increase circulation

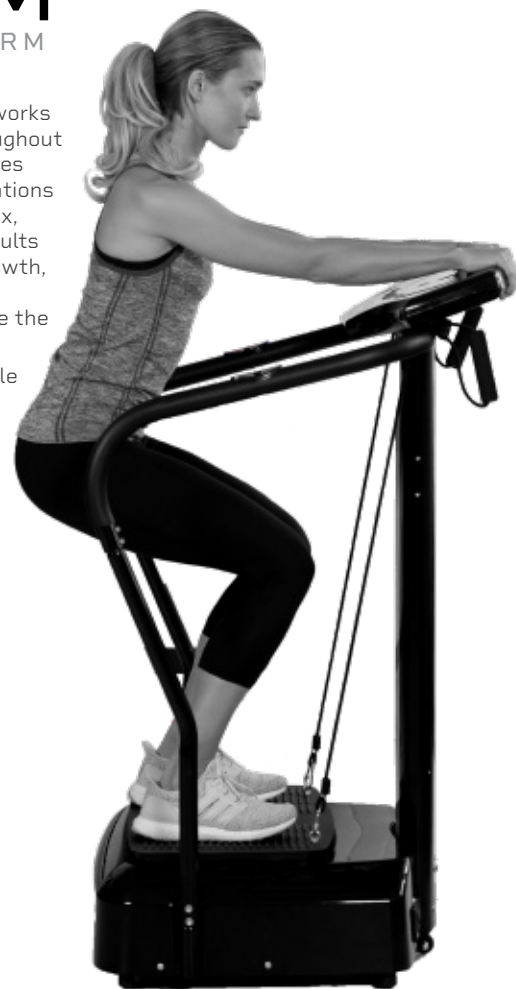

# SONIC

VIBRATING MESSAGE GUN



The Sonic Vibrating Massage Gun is a deep tissue massager that helps eliminate the aches and pains caused by long hours of sitting. Use the Sonic to release muscle tension and relax after a long day at work. Get relief from stiffness and pain in your shoulders, neck, wrists, and hands caused by prolonged digital device use.

The Sonic's vibration technology penetrates deeply into your muscles and fascia-treating areas that human hands have difficulty reaching. High-frequency vibrations loosen tight muscles, increase blood flow to the area, and reduce inflammation.

The Sonic is lightweight and portable, making it the perfect device to massage your own shoulders and back. Five speeds allow you to choose the intensity that will give you the most relief as you target specific muscle pain and stiffness.

## SONIC BENEFITS

- Reduce muscle pain and inflammation
- Release toxins
- Improve circulation
- Increase flexibility
- Reduce stress and muscle tension

# AGILITY

VIBRATING MESSAGE BALL

The Agility vibrating massage ball is designed to target small muscle groups. The Agility Ball is small enough to fit in the palm of your hand and gives you a wide range of massage motions: circular, up-and-down, and side-to-side.

The Agility Ball's silicone exterior is durable and easy-to-grip, but soft enough to use on sensitive areas like your neck, hands, and feet.

## AGILITY BALL BENEFITS

- Increase circulation
- Improve muscle flexibility and performance
- Relax tight muscles and fascia
- Reduce muscle pain and inflammation
- Boost blood flow





Access Lifepro TV, our library of free personal training videos on the web at [flexstride.lifeprofitness.com](http://flexstride.lifeprofitness.com) to learn how to get the most out of your Lifepro® FlexStride and achieve the results you want.



**YOU'VE  
GOT  
THIS**