

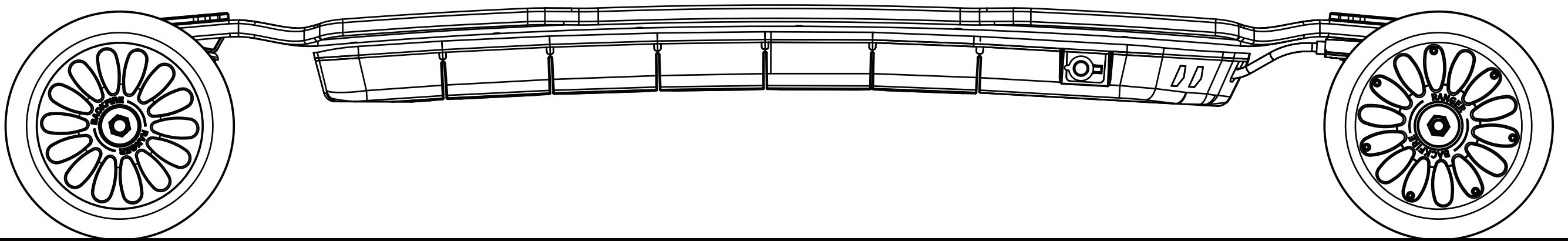

Ranner X5

User Guide



B SKATE BOARDS SINCE 2009

BACKFIRE-ELECTRIC SKATEBOARDS

⚠ WARNING ⚠

- RISK OF DEATH OR SERIOUS INJURY
- Whenever you ride a board, you risk death or serious injury from loss of control, collision, and falls. To ride safely, you must read and follow the instructions and warnings in the manual.
- **Always wear a helmet when riding.** Avoid water, wet surfaces, slippery / uneven surfaces, steep hills, traffic, cracks, tracks, gravel, rocks, or any obstacles that could cause a loss of traction and cause a fall. Avoid night riding, areas with poor visibility, and confined spaces.
- **WARNING: Do not ride diagonally on hills or on an incline of more than 10 degrees.** Do not ride at speed which you would not safely control the board. In case of wireless interference or battery error, you may need to rely on skating techniques like foot braking or sliding to stop.
- **WARNING: AVOID WATER!**
Your board is not completely waterproof, you can easily go through the puddles but don't soak the board in the water. Water damage is not covered under the warranty.
- **WARNING: PINCH POINTS!**
Keep fingers, hair, and clothing away from belts, motors, wheels, and all moving parts.
- **WARNING: RISK OF ELECTRONIC SHOCK!**
Do not open or tamper with electronics housing, which also voids the warranty.





PERSONAL PROTECTION

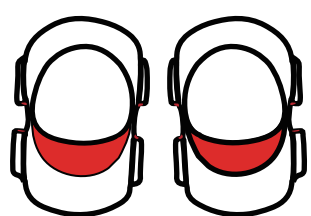

- ALWAYS WEAR A HELMET
- Find an open, flat area with clean pavement for your first ride.
- Follow these tips to ensure a safe riding experience:
 - Move the Throttle Wheel in small increments.
 - Keep a wide stance on the board.
 - Keep a low center of gravity.
 - Lean forward when accelerating.
 - Lean backward when braking.
 - Abide by the laws and regulations in your state or country.
 - Respect other drivers and pedestrians on the road.
 - Avoid riding in busy traffics and crowded areas.
 - Do not park your board in a way that blocks people or traffic, or may create a safety issue.
 - Cross roads at designated crosswalks or signaled intersections.
 - When riding with other riders, keep a safe distance from each other and other transport devices.
 - Identify and keep a safe distance from hazards and obstacles on the road.
 - Do not ride your board on private property unless you have obtained permission.

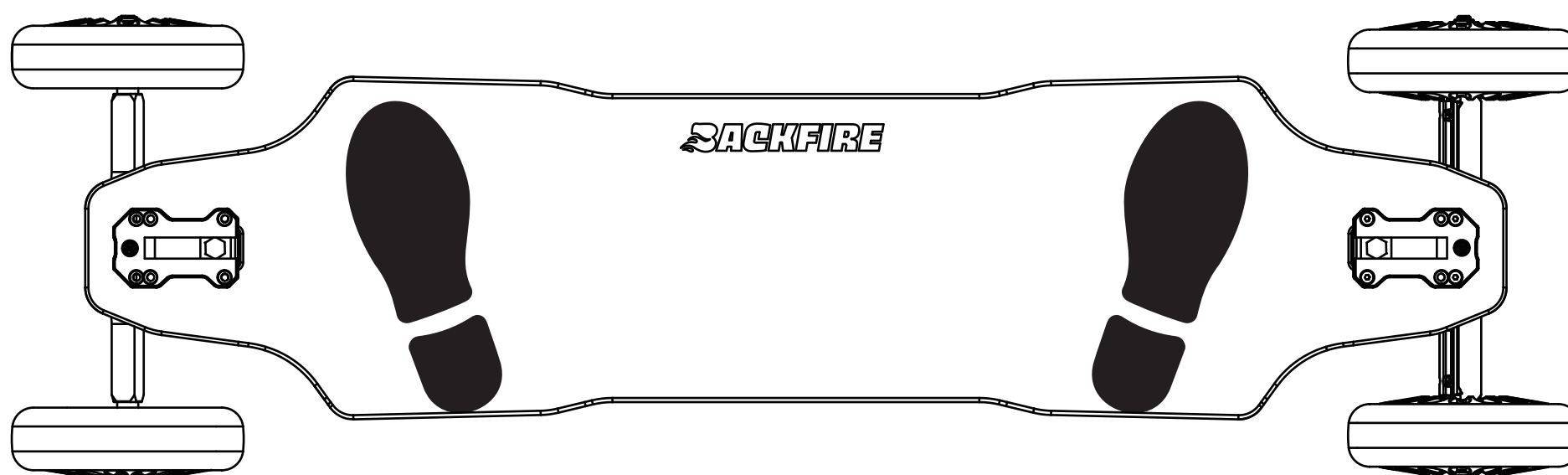

Please stand according to the diagram



Lean forward when accelerating to prevent falling backwards when the torque kicks in.



Lean back when braking to prevent being thrown forward by the sudden deceleration.

SPECIFICATIONS

Model: Ranner X5	Max. Range: 21 miles	Top Speed: 26mph
Max. User Weight: 110KG	Wheel Material: Airless Rubber Tires	Wheel Size: 165mm
Battery Charging Time: 3.5 hours	Truck: 10 inch DKP	Board Weight: 12.8Kg
Motor Power: 1500w * 2	Battery Capacity: 12AH 518WH	Deck Material: ABS+Glass fiber+ maple Composite deck
Riding Modes: Eco / Sport / Turbo	Motor Type: Hub motors	Battery Type: Lithium

REMOTE: HALO	Material: Aluminium alloy	Battery Charging Time: 2 hours
Battery Type: Lithium	Wireless Connection: 2.4GHz	Charging Voltage: 5V

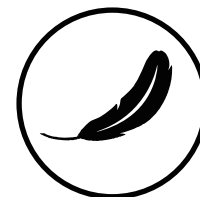
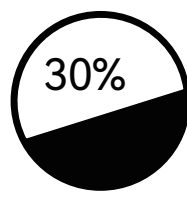
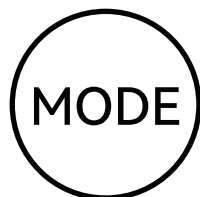

Four riding modes:

Economy Mode: Top speed of 11 MPH (19 km/h);

Sport Mode: Top speed is 23 MPH (38 km/h);

Turbo Mode: Top speed 26 MPH (42 km/h);

Cruise Mode: Travel at a steady speed.

30% uphill capability:

Actual performance depends on rider's weight and road conditions.

Board charging time 3.5 hours

Remote charging time 2 hours

Board net weight: 12.8Kg / 28lbs

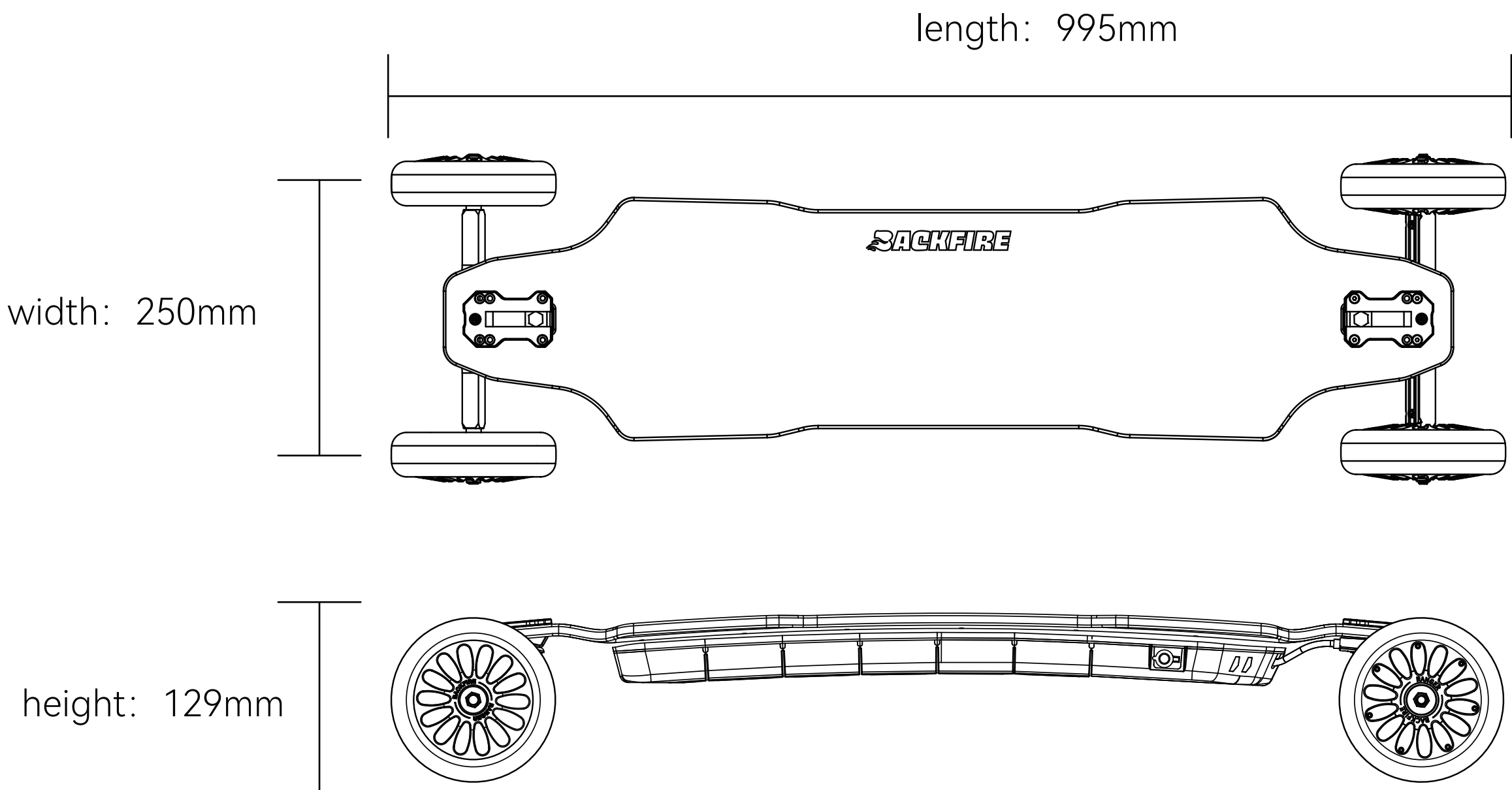



BOARD GLOSSARY

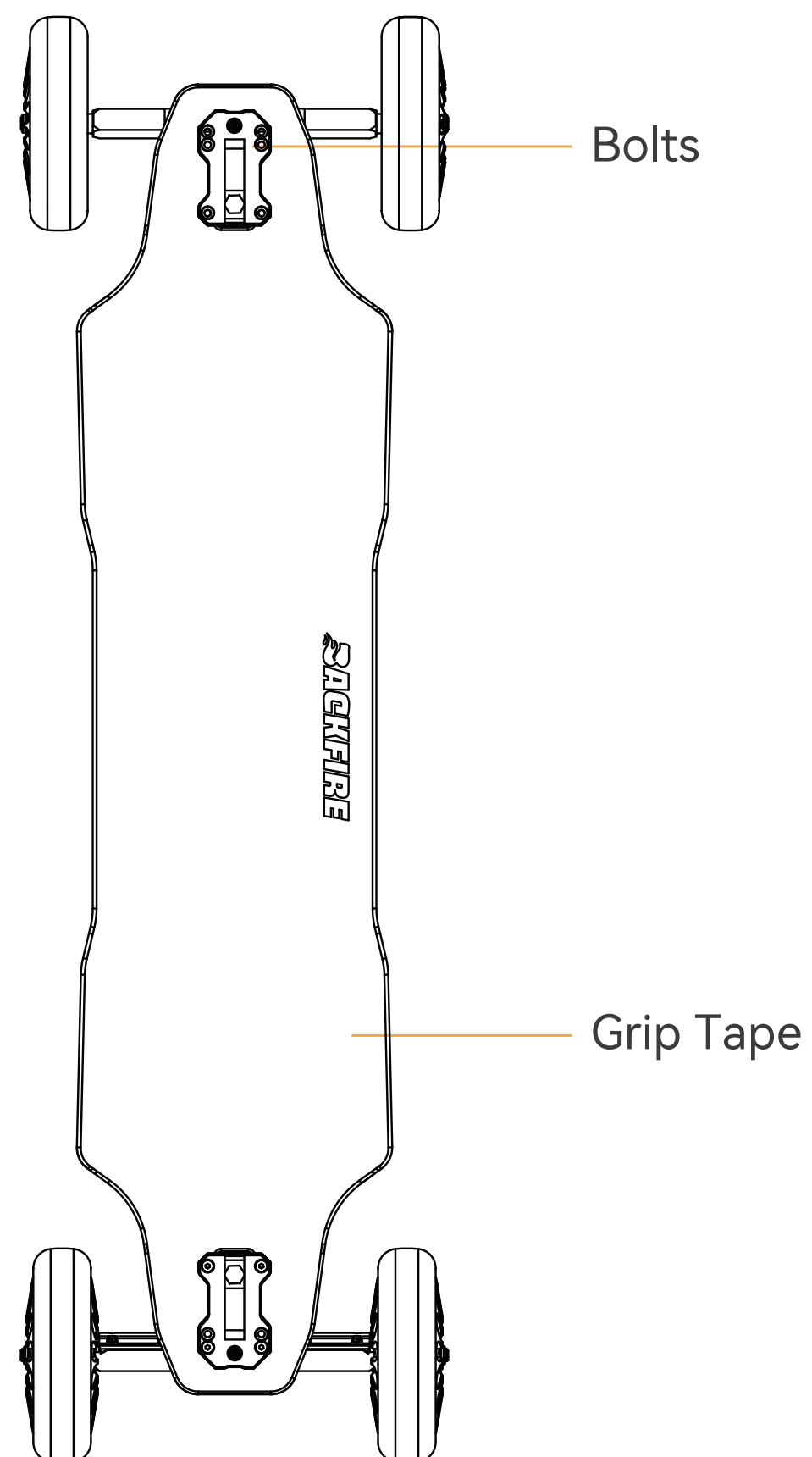
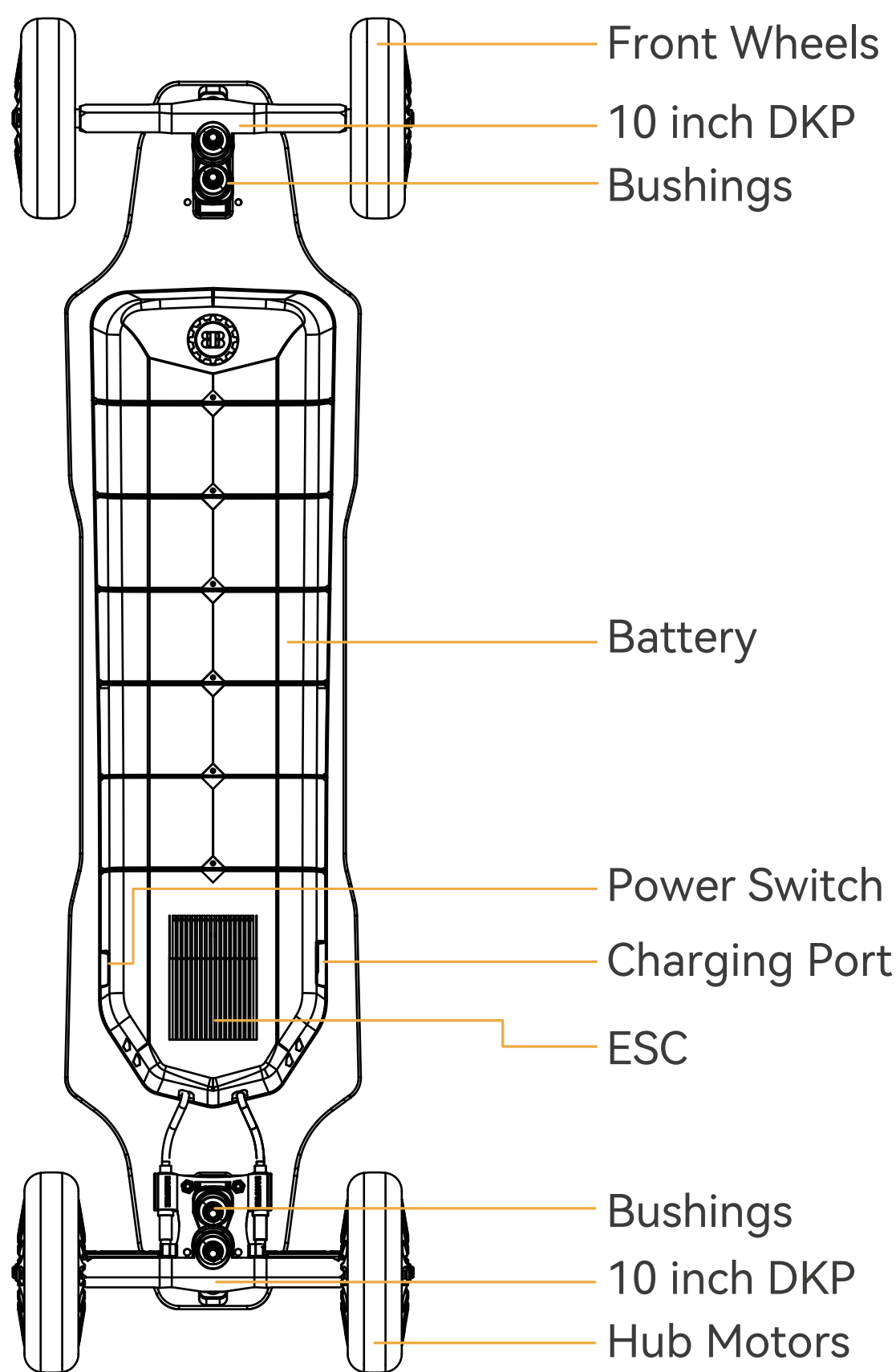

REMOTE GLOSSARY

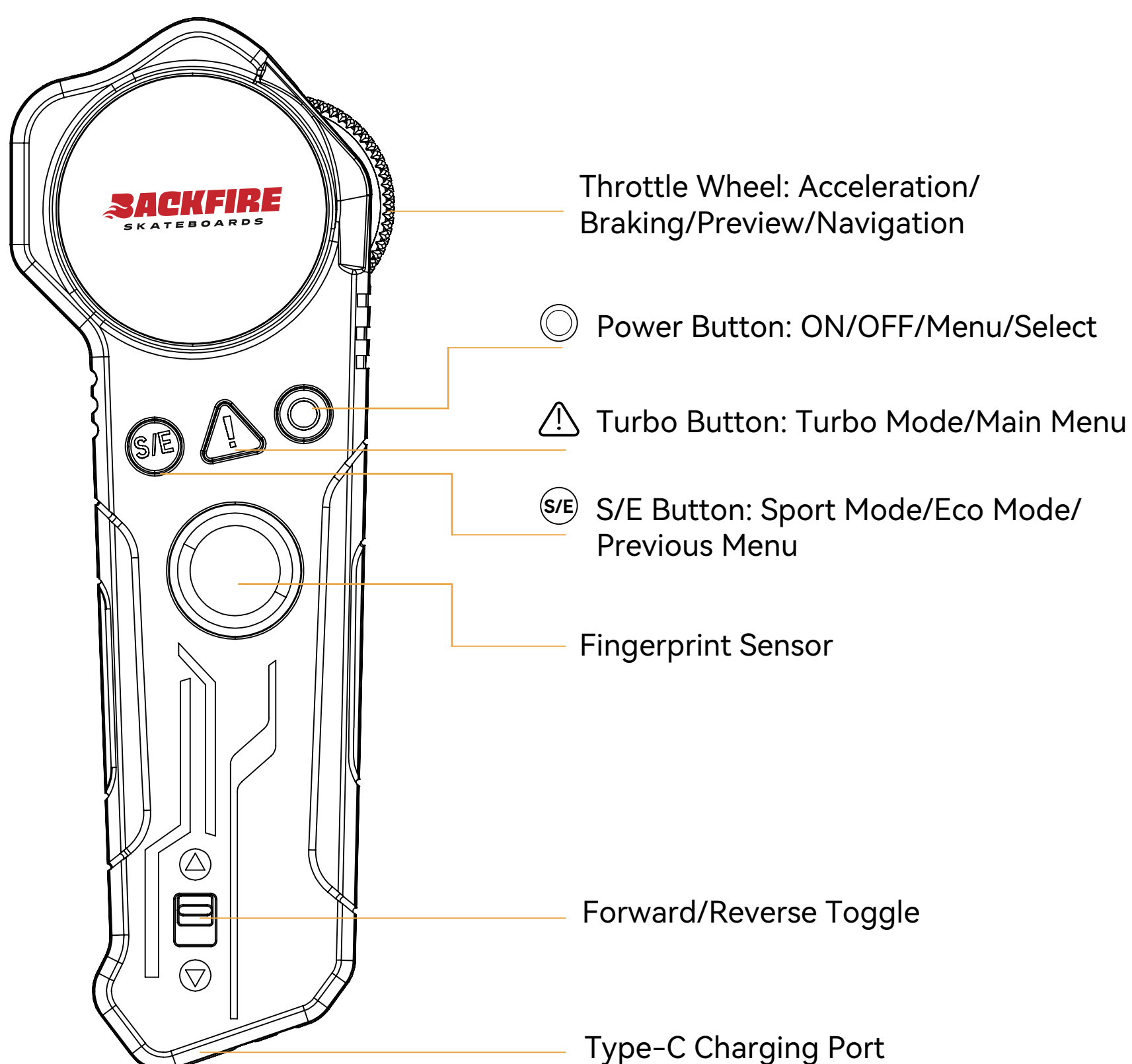

One-button start

When the skateboard is in standby mode, you can use the one-button startup feature on the remote control. Standby mode will automatically shutdown when the board is not activated for 3 days.

Double-click the power button to activate the board lighting on or off, and, to switch between lighting modes.

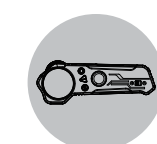

Aluminum Housing



Battery Capacity: 1000mAh



Voltage: 5V



Weight: 130g



Display Size: 1.3 inch



OLED display



2hr Charge Time



Fingerprint Sensor



PAIRING THE REMOTE TO THE BOARD

***The remote control and the skateboard are factory paired.**

This step should not be required unless advised by technical support staff.

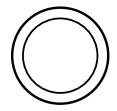

Hold the Power Button for 3 seconds to power ON/OFF the board.

When both the remote and board are in the OFF state, hold the Power Button on both the board and remote at the same time for 3 seconds to pair.



Auto-Pairing



Select 2WD



Select between KM and MILES using the Throttle Wheel, and press the Power Button on the remote to confirm your choice.

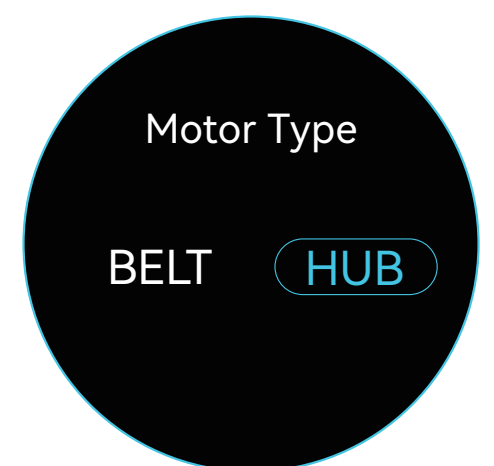

Select the drivetrain setup on your board using the throttle wheel.



Select the wheel size of your board using the throttle wheel. [Between 90MM-200MM]



Select the gear ratio of your drivetrain using the throttle wheel.

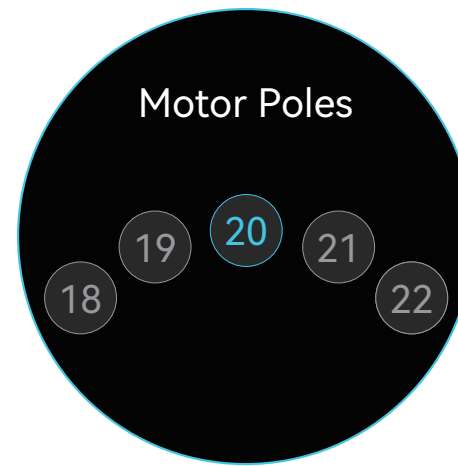

Select the number of Pole Pairs for your board's motor configuration. [Between 2-26]

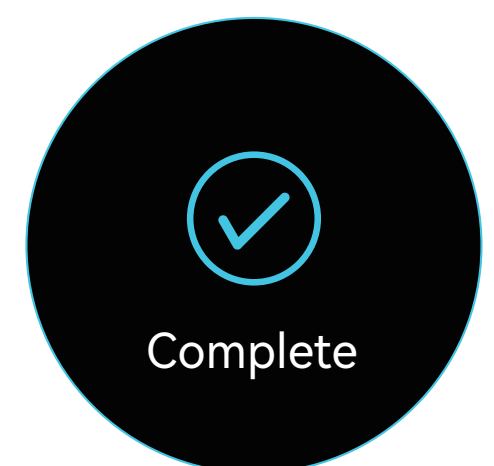

Pairing and configuration complete.



DIY WHEEL SETUP SHEET

Wheel Size	Gear Ratio	Pole Pairs
96mm	2.6	7
105mm Cloud wheel	2.6	7
120mm Cloud wheel	2.8	7
120mm PU wheel	3.1	7



STORAGE AND MAINTAINANCE

- Do frequent maintainance checks, make sure all nuts and bolts are tight before riding.
- Clean the skateboard regularly.
- Turn off board and controller when not in use.
- Recharge the battery in well ventilated area.
- Do not charge the battery in area with might wet the board or charging units.
- Do not charge the skateboard unattended.
- Stop using the product or charging unit if any wire is damaged.
- Only use appropriate chargers provided by Backfire.
- Do not use the board battery to power any other equipments.



BATTERY SAFETY

Tip: The battery will enter the hibernation state after the skateboard has been inactive for 7 days. If it cannot be turned on after receiving the skateboard, please charge and activate it first.

Lithium batteries can explode or cause a fire if they are used incorrectly. Therefore, it is recommended to read the following instructions very carefully:

Safety Warning:

- If you rode on wet ground with a risk of water entering your battery, please remove and check your battery.
- If there is any evidence of moisture, including water stains, disconnect the battery from your board immediately. Do not charge or use it!
- Keep the battery in a dry and fire resistant place to avoid potential fire risk (such as a sealed bucket outdoors).
- Do not keep a potentially water damaged battery indoors.
- Do not ship a potentially water damaged battery for service.

Contact Backfire for next steps:

1. In the USA: Tech@helloskate.com

2. Global: Adi@helloskate.com

- Moisture inside a battery pack can cause corrosion and short circuits in electronics such as the BMS, lighting or USB boards. This may occur in days or weeks after water ingress.
- The lithium batteries in your pack contain lithium cobalt oxide and organic solvents. These components can self-sustain a fire when a battery is subjected to short circuits, excessive heat or other stresses.
- Each time before riding the board, carefully check the battery pack and especially the protective seal. Make it is undamaged and intact. If in doubt, take the battery to a chemical waste disposal facility.
- Never drop the board.
- Store the board with battery inside in a dry place.
- Never expose the battery to tempreture above 100 celsius degrees.
- Only use offical board charger for charging board battery.
- Never leave the board unattended when charging.
- Never make the board work when charging.
- If you are not planning to use the board for about 2 months or longer, Please charge to 50%–60% and check it once a month. A lithium-ion battery that has been left empty for too long no longer be charged.
- Fully charge the battery before its first use to maximize long term battery performance.



WARRANTY

LIMITED WARRANTY:

We offer 6 months(180days) warranty on parts from the date when you receive the board.

If a defect arises during the Warranty Period, Backfire will, at its discretion:

- 1) Send the new parts to replace the defective parts.
- 2) Exchange the affected Products with functionally equivalent Products that are new or formed from new and/or previously used parts that are equivalent to new in performance and reliability.

This warranty excludes damage resulting from abuse, accident, modifications, unauthorized repairs, neglect, abuse, water damage, or other causes that are not defects in materials and workmanship.

This warranty excludes normal depletion of consumable parts (grip tape, wheels & bearings) unless due to a defect in materials or workmanship.

This warranty excludes gifts.

FOR ALL RETURN and WARRANTY SHIPPING:

Please keep your shipping box. The warranty does not include damage from shipping in insufficient packaging.

CONTACT US

TIKTOK: @backfireboards

Official Website: <https://www.backfireboards.com/>



Facebook



Instagram



You Tube



User Guide