



User Guide



Freedom for your dog. And you.

Congratulations—to you and your dog! You'll both have a more carefree life, now that you can easily create custom fences of almost any size and shape.



Don't want to read this booklet? Use our app. All of the instructions and tips are there, too.

Warnings:

There is no containment system, including a residential fence or the SpotOn GPS Fence, that can contain all dogs 100% of the time. Some dogs are very smart and can escape any containment. All containment systems can break or malfunction. Please monitor your dog regularly while using the system. If your dog is dangerous to others, do not rely on a containment system where they are unmonitored. In addition, this containment system cannot prevent predators from entering your fence area.

When creating fences, it is important to pay attention to your surroundings and watch where you are walking. Avoid staring at the SpotOn collar or app while walking a fence. Avoid dangerous areas that could result in serious injury or death.

Table of Contents

Getting Started	4
How SpotOn works	4
What's in the box	6
Fit the collar	7
Set Up	8
Step 1: Set up the collar and app	8
Step 2: Create and test a fence	10
A. Important fence guidelines	10
B. Create the fence	16
C. Complete and save the fence	17
D. Test the fence	18
Step 3: Train your dog	20
A. Set and test static correction	21
B. Set vibration feedback	21
Using SpotOn	22
Check collar status	22
Battery information	24
Turn on/off	24
Keep tabs on your dog - cellular plan and tracking	25
Tree coverage (Forest Mode)	26
Friends and family	26
Care and maintenance	26
Troubleshooting	27
Have a question? We'll fetch the answer!	29

Getting Started

How SpotOn works

With the SpotOn GPS Fence your dog can roam free within a designated area.

Our ingenious SpotOn System is the key. Put it on your dog when he's outside, and its patented True Location™ GPS technology helps keep him within a custom GPS fence that you create. Build custom fences anywhere you wish—in your yard and beyond. You'll use the app to set up SpotOn and create your first fence. Simply walk the boundary with the collar in hand and SpotOn automatically creates the fence.

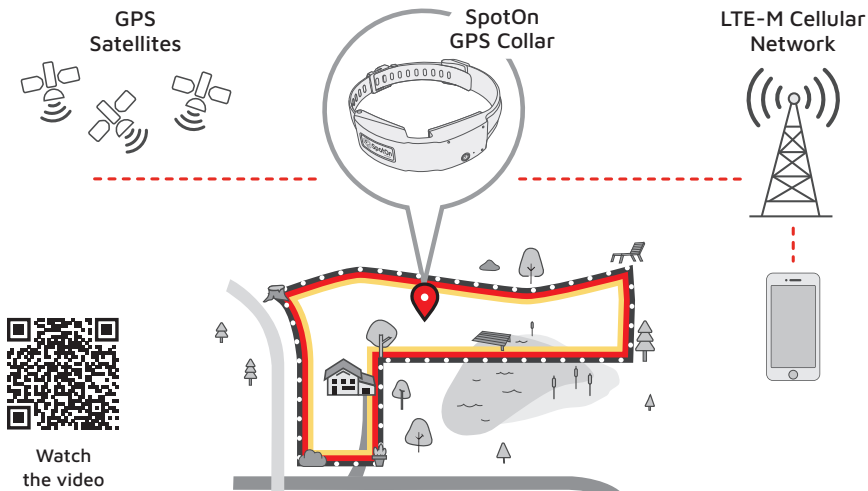

Then you'll teach your dog to know that the collar's dog-friendly tones mean he is near the boundary. This, coupled with vibration and static correction feedback will help him stay inside the GPS fence.

Plus, see your dog's location—any time, from anywhere—in the SpotOn app when you have a cellular signal.* And if your dog ever leaves the GPS fence area, you'll get notified on your phone.



Collar setup is easy. Use your phone to connect to the collar using Bluetooth. The app will lead you through the steps to connect SpotOn to your phone, just make sure your collar is within a few feet of your phone when you connect.

*To update your dog's location and receive collar notifications SpotOn requires its own cellular subscription to communicate with your phone. We offer a 90-day free trial. Visit spotonfence.com for more information.

What's in the box

SpotOn
GPS Collar



Charging
Base

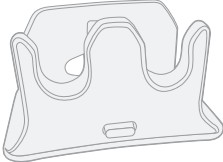

Wall
Charger

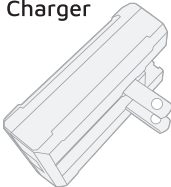

Charger
Cable

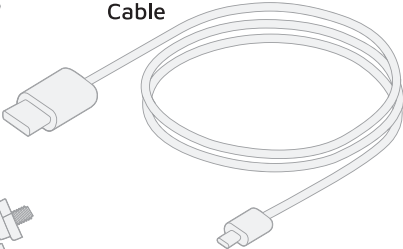

Contact
Point Tester

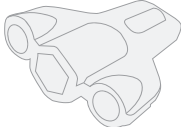

Contact
Points (2 Sets)

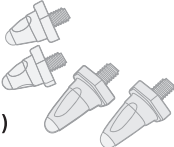

Fit the collar

SpotOn—available in S, M, and L—will fit most dogs that weigh 15 pounds or more and have a neck size between 10 inches and 26 inches.

Fit SpotOn to your dog like a regular collar. Use the adjustable strap so it fits snugly but lets you comfortably fit two fingers between the collar and your dog's neck. For more information on adjusting the strap, see page 29.

If you are planning to use static correction, install the static contact points before fitting the collar, see page 21.

When properly fitted, the GPS antenna should sit on the back of the dog's neck so the GPS icon is facing the sky.

Tuck any excess strap underneath the collar. Once you've found the proper fit for your dog (and if your dog is fully grown), you can trim the excess collar strap.

If it doesn't fit, please email us at support@spotonfence.com to exchange for a different size collar.

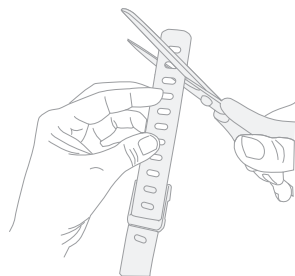
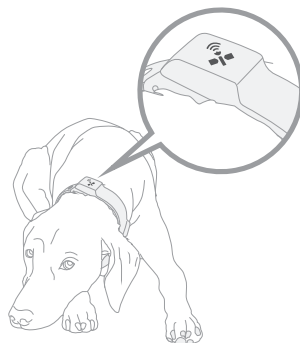

Setup

STEP 1: Set up the collar and app

A. Gather the items you'll need

- SpotOn collar
- Wall charger
- Charger cable
- Charging base

Set aside the other accessories for now.

B. Turn the collar on

Press and **hold** the Power Button until the LED starts flashing white. Then, the LED will turn to solid red and turn off after a few seconds.

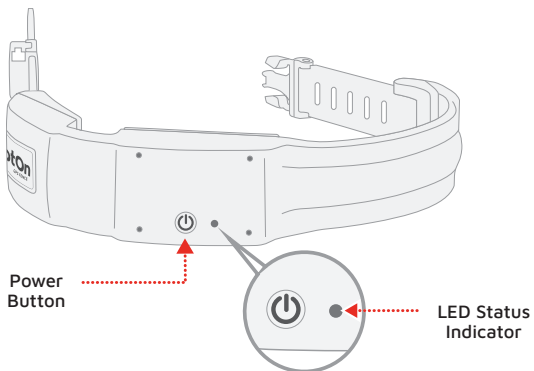

C. Charge the collar

- Connect the charger cable to the charging base and the wall charger, then plug in the wall charger.
- Put the collar in the charging base.

Once connected, the LED status indicator will slowly flash green, telling you that the battery is charging. It will take 90-120 minutes to fully charge the collar.

You can check the charge status by quickly pressing the power button while SpotOn is in the charger.

- Flashing green = charging
- Solid green = fully charged

D. Download our app

While SpotOn is charging, download the SpotOn GPS Fence app, then follow the steps to create an account and register your collar.

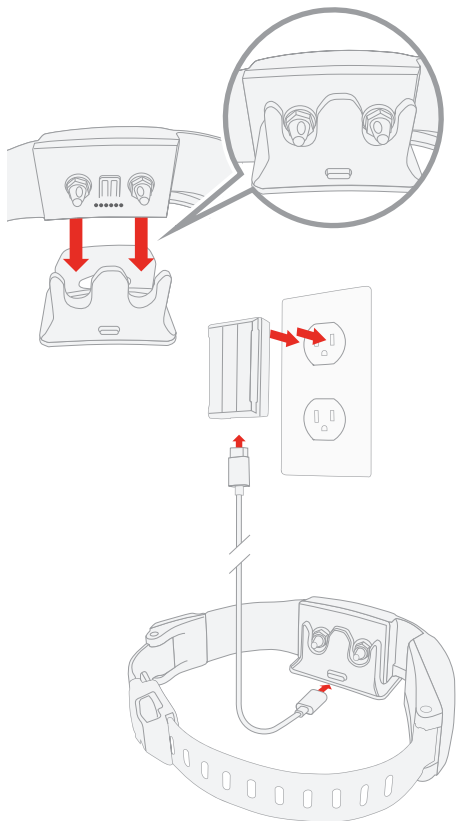

STEP 2: Create and test a fence

To build a virtual fence, you'll first plan the boundary and then walk your collar along the boundary (without your dog). As you walk, SpotOn automatically creates the fence.

A. Fence Guidelines

Before you create a fence, know these crucial guidelines. Scan the QR code to watch the video. (The guidelines are in the app, too, if you'd rather follow along there.)



Watch
the video

Allow for the fence alert/warning zone

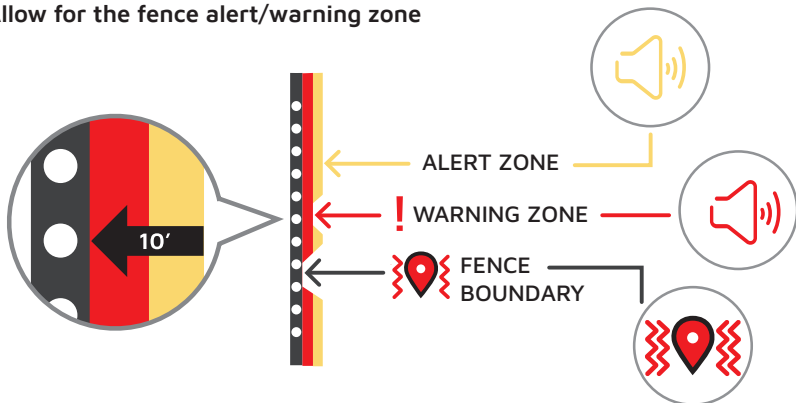

When you create a fence, SpotOn builds in an alert and warning zone about 10 feet inside the boundary that you walk. As your dog enters this zone, SpotOn makes a series of tones. You'll train your dog to understand these tones are the fence boundary.

Allow for fence boundary drift

SpotOn is more accurate than the GPS on your smartphone, but like all GPS systems, it can be affected by buildings, hills, heavy tree cover, the number of satellites detected, and other factors. This means your fence boundary will typically shift by less than 10 feet throughout the day. Since your dog will be trained to respond to the tones, not visual landmarks, drift will not confuse him or affect his ability to stay in the fence.

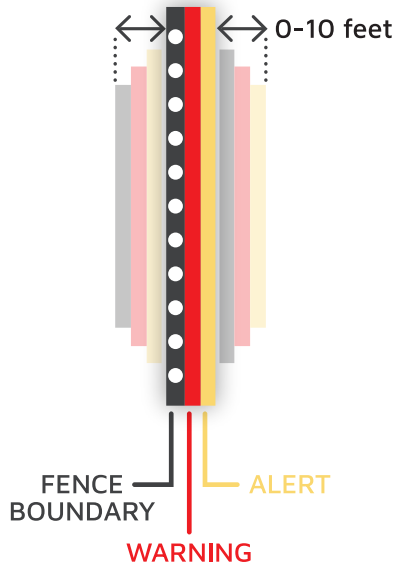

Minimum property size 1/2 acre

Because of the warning zone and fence boundary drift, fences built on properties that are less than 1/2 acre typically do not provide enough open space for your dog to roam.

Minimum width for fence area

To provide enough space for your dog to roam keep the distance between fence boundaries at least 80 feet wide at the narrowest point.

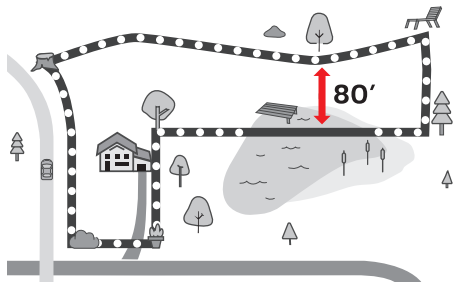

Minimum distance from roads and hazards

Set boundaries at least 15 feet away from roads or any other hazardous areas.

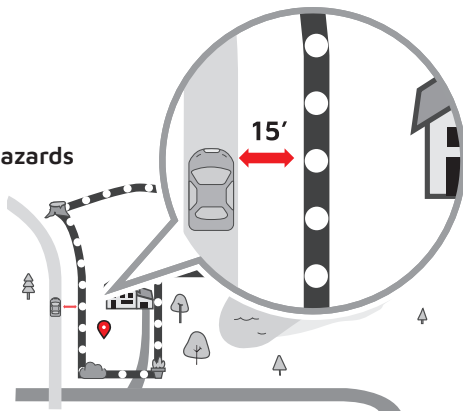

Minimum width for a passageway

Buildings can interfere with GPS signals. To create a passageway between front and backyard along a house, make sure there is at least 30 feet between the fence and your home or any other structure.



Keep the house inside the fence

To allow your dog to enter your home without being corrected, make sure the house is inside the fence area. For a fence that only covers the backyard be sure to run the fence boundary along the front and sides of the house. This allows your dog to enter the house through the back door without being corrected.



Use Pause to fence through obstacles

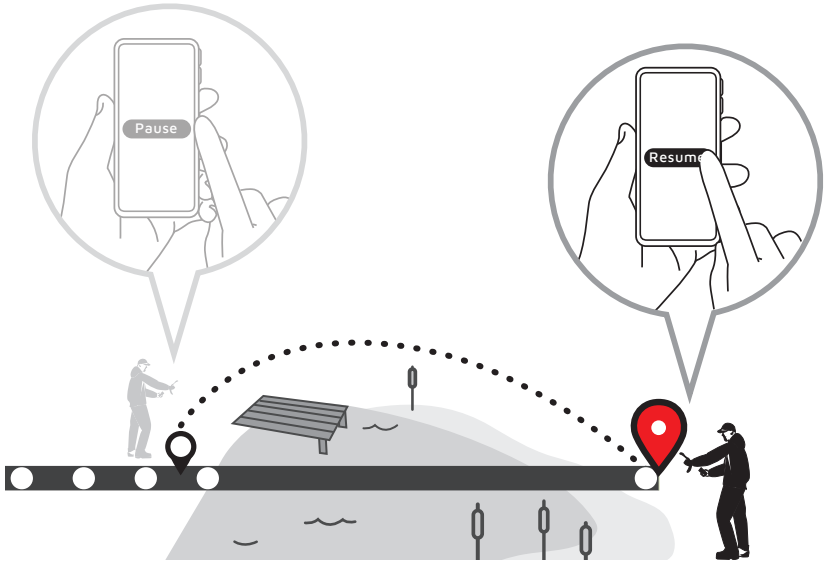

Hit an obstacle you can't walk through, like a pond or thick brush? Using the app press Pause to manually drop your next fence post, go around the obstacle and then press Resume. SpotOn will snap a fence line between fence posts.

Use Pause for Fences larger than 5 acres

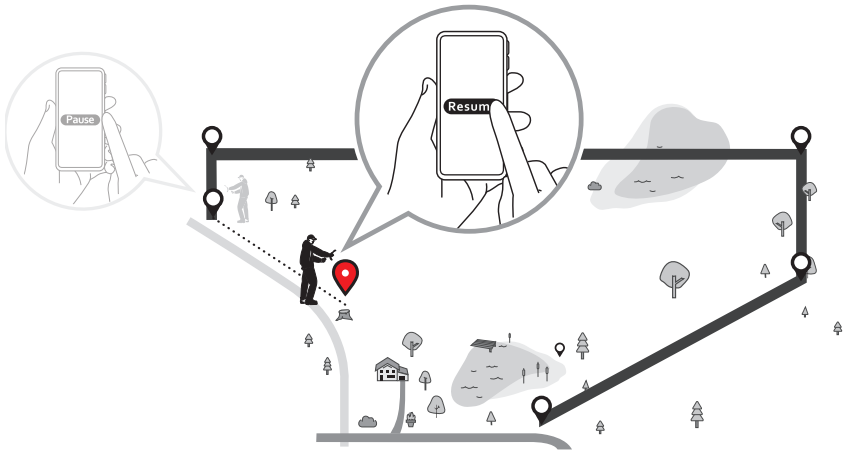

For large fences of 5 acres or more, use the Pause function to manually control the number of fence posts, so you don't run out. This will also reduce the fence file size and help the fence load faster.

Using the app start at one boundary point, press Pause and then walk (or drive) to the next point. Tap Resume and the system will snap a fence line between fence posts.

TIP:

The app will automatically inform you when you have used half of your fence posts.

B. Create the fence

You'll need a fully-charged collar and your phone to create a fence. Go outside with the collar and the app. Follow the instructions in the app to connect your phone to the collar, wait until your collar has acquired a GPS signal, and you're ready to create the fence.

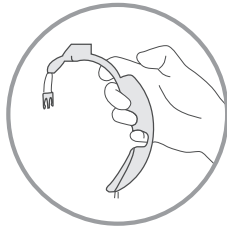

Hold the collar with the GPS antenna facing the sky

Move to a starting landmark



Tap Start on the app



Walk the boundary



As you walk SpotOn automatically places one virtual fence post about every 5 feet. You don't need to walk in straight lines—the boundary can be curved if needed. And if you stand still for a moment SpotOn will wait until you move.

C. Complete and save the fence

When you approach the starting point the app will automatically inform you to tap finish. SpotOn will complete the fence and then ask you to name it.

Create additional fences

Tap the Fence section in the app and tap Add Fence.

You can save up to 10 separate fences at any time. Using the app, select and upload the desired fence to the collar.

You can also create an instant circular fence. Using the app, select Create a Fence and then select Circular Fence.

NOTE:

It's important to tap Finish before you reach the starting point. If you don't your fence may not properly save.

TIP:

Need a fence larger than 5 acres? First create a smaller fence to get familiar with the way your fence works.

D. Test the fence

Once you've saved a fence, you'll need to confirm the boundaries.

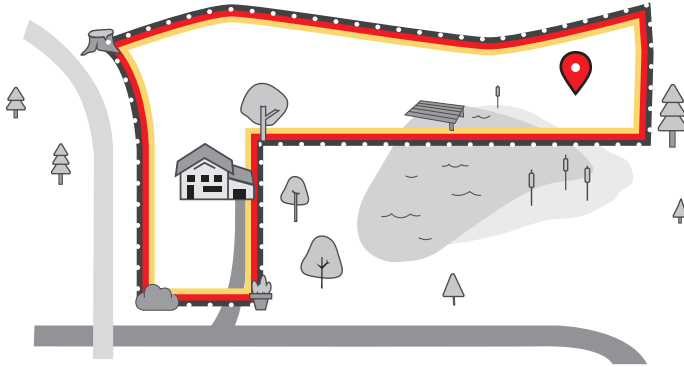

1. Hold the collar and stand well inside the fence area, at least 20 feet from the boundary.

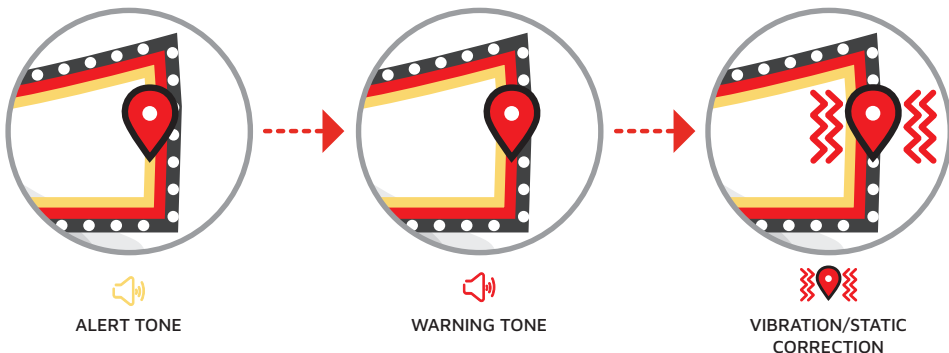

2. Walk toward the boundary and when you're about 10 feet away, you will hear the alert tone.

3. Then at about 5 feet from the boundary, you'll hear the warning tone.

4. Finally, the collar will vibrate once you reach the boundary.

NOTE:

If you choose to use static correction for your dog, it will also be applied at the boundary. You can use the static contact tester to verify static correction is working. Place the tester over the static contact points and walk across your fence boundary. The tester will glow when static correction is applied.

STEP 3: Train your dog

Now it's time to get your dog ready for a life unleashed! That means training him to recognize alert and warning tones.

It'll take a little commitment and consistency. Stick with it and you'll have success like so many SpotOn owners before you.

Recommended training schedule: 15 minutes a day, for a week or 2.

That's how long it takes a dog, on average, to learn.

All dogs are different, so don't worry if your dog takes a little longer. Keep training sessions quick and fun to lessen stress on your dog—and you.

Check out the app for more training information.



View
training plan

TIP:

Need some extra training support? Contact training@spotonfence.com to learn more about a remote training session with one of our SpotOn expert trainers.

A. Set and test static correction

Want to use optional static correction? You must attach static correction contact points to the collar. Two sizes are included so you can choose the right ones for your dog—short for short-haired or long for long-haired dogs. To install, screw the probes into the back of the collar and tighten them with the included tool.

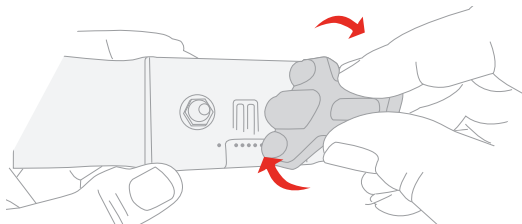

Go to Collar Settings in the app and choose from 30 levels of static correction to fit your dog's unique needs.

NOTE:

When setting static correction, it is important to start at level 1 and work your way up, based on how your dog responds. See Train Your Dog in the help section of the app.

B. Set vibration feedback

Vibration Feedback provides an alternative to static correction at the fence boundary, or an extra level of protection used with static correction. Go to Collar Settings in the app to turn vibration on or off.

Using SpotOn

When indoors, remove the collar from your dog and keep it on the charger so it is always ready for use.

Before going outdoors, be sure the system is ready to go before you put the collar on your dog. You can check the status on the collar or on the app.

Check collar status

Press and immediately release Power Button. The LED Status Indicator will turn on for a few seconds, then turn off.

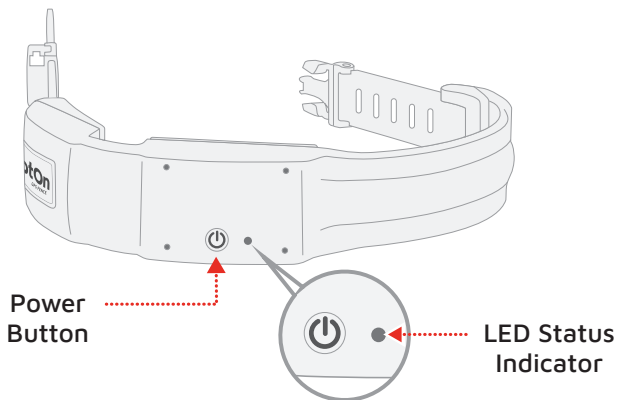

LED Status Indicator	Status	What To Do
Solid White	System is ready to go. Fence activated; collar has GPS signal.	Put the collar on your dog, then send him outside.
Flashing White	Fence active, but no GPS signal.	Move outdoors and wait a few moments for SpotOn to get a GPS signal.
Solid Red	System not ready.	<p>Fence may be inactive. Tap Dog in the app to select your fence.</p> <p>Collar may have a low battery. Place it in the charger.</p> <p>See app for additional suggestions.</p>

Battery information

Once fully charged, the collar's battery provides about 18 hours of containment and about 12 hours of tracking time.

NOTE:

You can also use the app to connect to the collar and check charge status.

LED Indicator	Charge Status
Solid Green	System is fully charged
Flashing Green	System is charging

Turn on/off

To turn the system on, press and **hold** the Power Button until the LED starts flashing white. Then, the LED will turn to solid red and stop illuminating after a few seconds.

To turn the system off, press and **hold** the Power Button until the LED status indicator turns off. When you turn it on again, you will have to download one of your saved fences to the collar before activating.

TIP:

There's no need to turn the system off, even when charging, so it's always ready to use. If you do power down you'll need to use the app to connect to the collar and select and activate the fence the next time you turn the system on.

Keep tabs on your dog with a cellular plan

SpotOn capabilities are well beyond those of traditional fences. Your SpotOn collar is an internet-enabled device that can communicate your dog's location to your smartphone using cellular data.

SpotOn's cellular uses LTE-M technology, which works in many places where your phone's 4G may be weak or unavailable. SpotOn is able to communicate with your phone regardless of your phone's carrier (similar to if you have AT&T and call a friend who has Verizon).

Enjoy all the benefits of SpotOn with a cell plan.*

- See your dog's whereabouts with the touch of a button. When in containment, you can see your dog's location anytime by tapping Refresh Location in the Tracking section of the app.
- Get notified, within seconds, when your dog goes outside the fence. SpotOn will track his movements in realtime in the app, updating his position on the map every six seconds until you are reunited (both your phone and SpotOn must be in an area with good cell service).
- A 90-day free trial offers extra protection as your dog learns the fence.

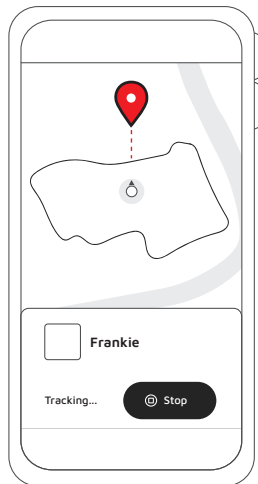

*SpotOn's fences use GPS technology alone. You can create, manage, and use fences without a cellular subscription.

Tree coverage (Forest Mode)

Dense tree cover (where you cannot see portions of the sky through the trees) may affect GPS reception. Forest mode improves the collar's performance in those circumstances. Refer to collar settings in the app.

Warning:

If the collar is in "Forest Mode," always take it off your dog when coming indoors and deactivate the fence to avoid the risk of your dog receiving a false correction.

Friends and family

Invite friends and family to care for your dog. You can give them permission to create and manage fences, set static correction and vibration, and track your dog. See the profile section in the app for details.

Care and maintenance

SpotOn is waterproof to IP67 standards. Before using it in wet environments, make sure the collar doesn't have any nicks, cuts, cracks, or other damage that might let water inside. Rinse the collar with tap water and pat dry after exposure to dirt, mud, saltwater, or pool water.

Troubleshooting

If you experience a problem, please refer to the table below or the help section of the app. If you're unable to resolve the issue, give us a call at (603) 488-1504.

Symptom	Solution
Collar does not turn on	Place the collar on the charger and allow system to charge for about an hour.
Collar won't charge (no flashing green light)	<p>Confirm that collar is fully seated in the charging base and that the cable and wall charger are connected.</p> <p>Make sure charge contacts on the collar and charging base are free of any dirt or debris.</p> <p>Connect the USB cable to a different power supply.</p> <p>Use a different USB cable.</p> <p>Connect to a different AC power source.</p>
I'm not receiving notifications. I'm not able to activate tracking or refresh my dog's location.	<p>Check to be sure you have a cellular subscription, and it is activated.</p> <p>If you don't have a cell plan, visit www.spotonfence.com/pages/subscription to subscribe.</p> <p>If you have a cell plan, make sure you have cell service. Check the app for more information.</p>

Symptom	Solution
The collar LED status indicator is solid white	System is ready to go. Put the collar on your dog, then send him outside.
The collar LED status indicator is red	See app for details. Use the app to connect to the collar. Fence may be inactive, or collar may have a low battery.
The collar LED status indicator is flashing white	Move outdoors and wait a few moments for SpotOn to get a GPS signal. Connect to the collar and see app for details.
The app indicates poor GPS signal	Move outdoors and wait a few minutes, making sure the GPS antenna is pointing toward the sky.
My dog is escaping the fence area	Refer to the training section of the app for more information or give us a call.
I'm not sure if static correction is working	Using the app, connect to the collar to confirm that the fence is active and static correction has been activated. Then attach the contact point tester to the contact points. Walk toward the boundary. When you reach the boundary the clear side of the contact point tester should glow orange. If not, please give us a call.

Symptom	Solution
I'm not able to connect to my collar using the app	<p>Move the collar and phone to within a few feet of each other and be sure Bluetooth is activated on your phone.</p> <p>Note: The Bluetooth connection is used for collar set-up, fence creation, and while you train your dog. Keep the collar and phone within 50 feet of each other during these activities.</p>
Collar needs to be updated	The app will indicate if a software update is available. Follow the instructions to update your collar.
I need to adjust the strap	Adjust the collar by loosening the clasp and sliding it toward the center of the collar for a tighter fit, or toward the end of the strap for a looser fit. Be sure to lock the clasp in place before fitting the collar on your dog.

Have a question? We'll fetch the answer!

You can reach us by:

Call us at (603) 488-1504 or Email at support@spotonfence.com.

You can also browse the help section in our app.

Regulatory Information

Regulatory information is included on the product label.

This device complies with part 15 of the FCC Rules. Operation is subject to the following two conditions: (1) This device may not cause harmful interference, and (2) this device must accept any interference received, including interference that may cause undesired operation. See 47 CFR Sec. 15.19.

This device complies with Industry Canada's license-exempt RSSs. Operation is subject to the following two conditions: (1) This device may not cause interference; and (2) This device must accept any interference, including interference that may cause undesired operation of the device.

SpotOn has been tested and meets applicable limits for human radio frequency (RF) exposure per the FCC.

Specific Absorption Rate (SAR) refers to the rate at which the human body absorbs RF energy. The SAR limit is 1.6 watts per kilogram in countries that set the limit averaged over 1 gram of tissue. During SAR testing, SpotOn radios are set to their highest transmission levels and placed in positions that simulate typical worst-case use conditions when near the body of a person. SpotOn has successfully demonstrated compliance to SAR requirements.

SpotOn has not approved any changes or modifications to this device by the user. Any changes or modifications could void the user's authority to operate the equipment. See 47 CFR Sec. 15.21.

Terms of Use

This product, associated mobile application, and website are owned by OnPoint Systems, LLC (D/B/A SpotOn Fence). By using any of them, you agree to the terms and conditions outlined at <https://www.spotonfence.com/pages/terms-of-use>. Please read these terms carefully.

In order to provide you with a better experience, we may view or collect personally identifying information about you. Please read our Privacy Policy at <https://spotonfence.com/pages/privacy-policy> for details. We contract with other companies who provide us with certain services, including, without limitation, hosting, market research, data analytics, third party advertising, promotions management and payment processing. We provide these companies with only the information they need to perform their services and require them to ensure that your privacy is protected. These companies are prohibited by contract from using this information for their own marketing purposes or from sharing this information with anyone other than SpotOn Fence.



The Bluetooth® word mark and logos are registered trademarks owned by Bluetooth SIG, Inc. and any use of such marks by SpotOn is under license. Other trademarks and trade names are those of their respective owners.

