

Tu depósito dental de confianza

CCS Dental

Distribuidor Oficial TePe en España

T. +34 93 137 02 06 / Móv. 655 076 085
info@ccsdental.es · <https://ccsdental.es>

 Facebook
CCS Dental

 LinkedIn
CCS Dental

 Instagram
@ccs_dental

Instrumental SCHWERT

Hecho en Alemania · La precisión · Los conocimientos acerca de la funcionalidad · La materia prima · Articulaciones de alta precisión · Insertos de carburo de tungsteno · Fácil mantenimiento y limpieza · Gestión de la Calidad · El servicio



1790-225

antes
~~1.284~~€
ahora
849€

Está compuesto por los siguientes instrumentos:

- 1033-60 - Mango para bisturí SAFE-EX
- 1125-400 - Tijeras para encías Joseph curvas 14 cm.
- 1208-300 - Fórceps Micro 17.5cm recto 1x2 dientes
- 1208-355 - Pinza micro sutura
- 1372-1 - Cureta de Lucas (no dentada)
- 1411-08 - Elevadores de periostio Prichard
- 2000-60 - Porta aguja tc micro 17.5cm
- 2460 - Retractor de lengua y mejilla minnesota
- 2887 - Pinza College
- 3418-15 - Sondas Periodontal fig. Cp15
- 2610-1 - Bandeja con bastidores 266 x 180 x 36

120 YEARS

Curetas GRACEY puntas roscadas



3305-04S 204S **3301-01M5** GRA 1/2M5 **3301-07M5** GRA 7/8M5 **3301-11M5** GRA 11/12M5 **3301-13M5** GRA 13/14M5

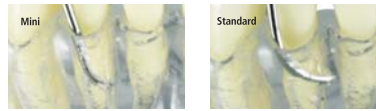

3301-100M5

Instrumental dental que incluye el kit:

Cureta de Gracey: 1/2M5
Cureta de Gracey: 7/8M5.
Cureta de Gracey: 11/12M5.
Cureta de Gracey: 13/14M5
Sickle Scaler 204S.
Bandeja 599-05.

antes ~~227€~~
ahora **159€**



antes ~~36€~~
ahora **29€**
/ud.

OFERTA
5+1
CURETAS



antes ~~67€~~
ahora **54€**
/ud.

Curetas para IMPLANTES puntas de Titanio

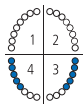

3303-01Ti
L 1/2

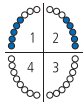

3303-03Ti
L 3/4

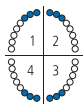

3303-05Ti
L 5/6

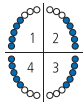

3302-04Ti
CU 4R/4L



3300-00
Key to exchange
working tips

29€
/ud.



Curetas para implantes de uso múltiple con insertos de titanio intercambiables y muy delicados para eliminar la placa acumulada en los cuellos del implante. Los insertos de titanio son reafilables.



Periostotomos

antes ~~86€~~
ahora **68€**
/ud.

1411-08

PRICHARD
Spatula / 4,0 mm
periosteal, exchangeable
17,5cm,



1411-01

MOLT
2,5 / 4,0 mm
17,5 cm

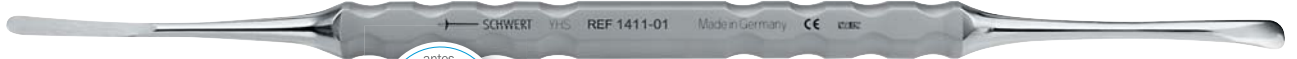

antes ~~59€~~
ahora **48€**
/ud.

1411-03

GLICKMAN
FIG. 24G
17,5 cm

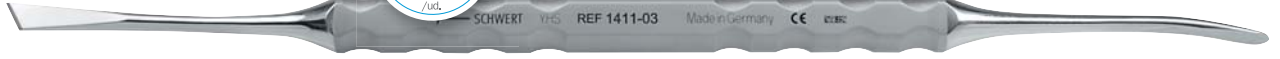

1411-04

MICRO BUSER
2,4 / 2,8 mm
17,5 cm

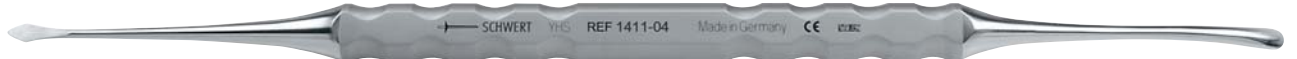

1411-05

BUSER
3,8 / 4,2 mm
17,5 cm

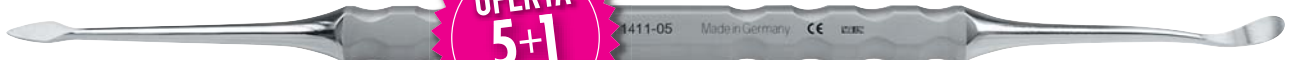

OFERTA
5+1
PERIOSTOTOMOS



Selección MICROCIRUGÍA



2000-60
twist TC
Recta, 17,5 cm



2000-66
twist TC
Curva, 17,5 cm

antes ~~354€~~
ahora **247€**
/ud.



1135-17
MICRO
17,5 cm, Ø 8,0 mm
micro serrated, curved



1136-17
MICRO
17,5 cm, Ø 8,0 mm
curved, fine



1137-17
MICRO
17,5 cm, Ø 8,0 mm
curved, very fine

antes ~~256€~~
ahora **179€**
/ud.



1208-355
Micro suture forceps
Ø ring: 2,0 mm, 17,5 cm

antes ~~133€~~
ahora **93€**
/ud.



1208-345
COOLEY
atraumatic tips, 17,5 cm

antes ~~170€~~
ahora **119€**
/ud.



1208-340
COOLEY
atraumatic tips, 17,5 cm

antes ~~162€~~
ahora **113€**
/ud.



1208-300
1x2 teeth
17,5 cm
with suture plate*

antes ~~140€~~
ahora **98€**
/ud.

4/0 - 8/0

*Micro surgical tweezers with suture plate. The micro teeth securely hold the mucoperiosteal flap. With the suture plate behind the micro teeth the surgeon securely can guide the suture while suturing.

Mangos de Bisturí y hojas micro

OFERTA 5+1 EN HOJAS

SAFE-EX patented

1050
Blade remover
DE REGALO POR MÁS DE 200€ DE COMPRA

Modelo	Material / Descripción	Antes	Ahora
1033-60	Safety blade holder, ergonomic shape, dismountable	122,19€	85€ /ud.
1033-50	Blade holder, stainless steel, ergonomic shape	46,27€	33€ /ud.
1070-00	Blade holder, titanium ergonomic shape	151,40€	105€ /ud.
1070-64*	FIG. 64, 3,2 cm, 10 pcs., sterile	25€	19€ /ud.
1070-67*	FIG. 67, 3,2 cm, 10 pcs., sterile	25€	19€ /ud.
1070-69*	FIG. 69, 3,2 cm, 10 pcs., sterile	64€	51€ /ud.

Tijeras

OFERTA 5+1 TIJERAS

Modelo	Características	Antes	Ahora
1133-400 / 1133-400B	La Grange, 11,5 cm	84,87€	68€ /ud.
1117-400 / 1117-400B	Goldman-Fox, 13,0 cm	73,77€	59€ /ud.
1139-400B	Metzenbaum, 14,0 cm	148,41€	118€ /ud.
1110-400 / 1110-400B	Iris * Recta, 11,5 cm	130,93€	104€ /ud.
1111-400 / 1111-400B	Iris * Curva, 11,5 cm	110,97€	88€ /ud.
1125-400 / 1125-400B	Joseph, 13,0 cm	88,50€	71€ /ud.

1133 antes 60€ ahora 48€ /ud.

1117 antes 55€ ahora 44€ /ud.

1139-14 antes 49€ ahora 39€ /ud.

1111 antes 39€ ahora 31€ /ud.

1125 antes 62€ ahora 49€ /ud.

Instrumental SCHWERT

Hecho en Alemania · La precisión · Los conocimientos acerca de la funcionalidad · La materia prima · Articulaciones de alta precisión · Insertos de carburo de tungsteno · Fácil mantenimiento y limpieza · Gestión de la Calidad · El servicio

Forceps

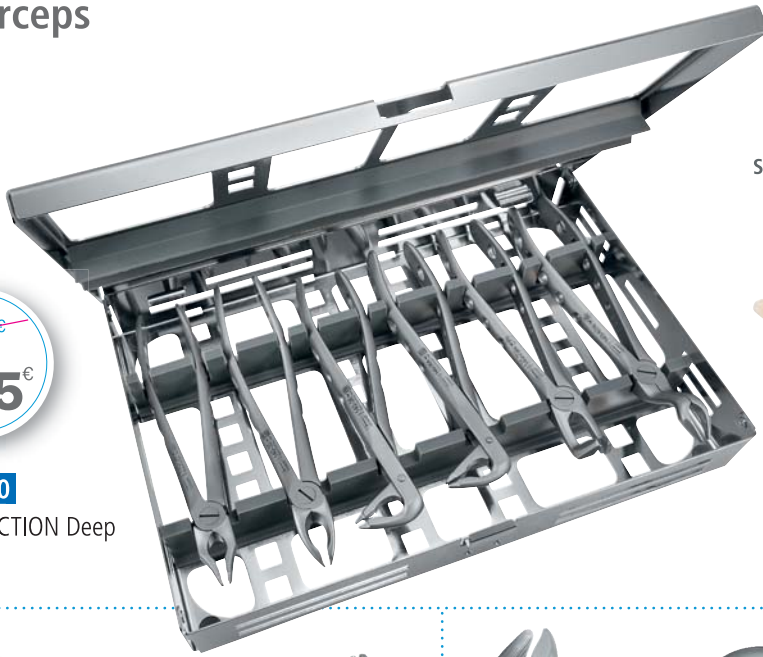

antes ~~850€~~
ahora **595€**

140-110
TAC-TRACTION Deep Grip Kit

TAC-TRACTION

Standard Forceps



Deep gripping forceps



OFERTA
5+1
FORCEPS

antes ~~119€~~
ahora **95€**
/ud.



140-34*

FIG. 34
16,0 cm

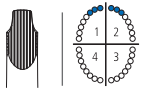

140-35*

FIG. 35
16,0 cm

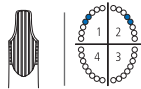

140-67N*

FIG. 67N
17,5 cm

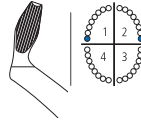

140-36*

FIG. 36
16,0 cm

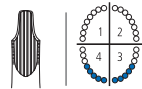

140-36A*

FIG. 36
16,0 cm

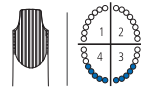

140-79N*

FIG. 79N
16,0 cm

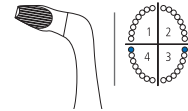

antes ~~131€~~
ahora **104€**
/ud.

* Included in kit



antes ~~336€~~
ahora **235€**
/ud.

503
BEYER



1418-3
Easy bone collection tips 3mm / 5mm

antes ~~86€~~
ahora **59€**
/ud.



1933-1
KIM
10.5 mm width, flat, 45° angulated

antes ~~119€~~
ahora **83€**
/ud.



1933-50
LASTER special wound retractor for upper impacted wisdom teeth, tip micro serrated, 10 cm

antes ~~97€~~
ahora **68€**
/ud.



BECK Elevators

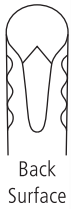

antes ~~63€~~
ahora **49€**
/ud.



615-2
BECK
3,5 mm



615-3
BECK
4,0 mm



615-1
BECK
2,8 mm

617-21
P-LUX Periotome
curved



617-10 4,5mm

617-11 4,5mm

617-07 4,0mm

617-12 4,0mm

617-13 4,0mm

antes ~~68€~~
ahora **55€**
/ud.



LUCAS Curetas / non serrated

1372-0
1,5 mm

1372-1
2,5 mm

1372-2
3,0 mm

antes ~~60€~~
ahora **48€**
/ud.

LUCAS Curetas / serrated

1372-10
1,5 mm

1372-11
2,5 mm

1372-12
3,0 mm

antes ~~61€~~
ahora **49€**
/ud.

OFERTA
5+1
P-LUX Y LUCAS



617-20
P-LUX Periotome
straight

2,5mm **617-01**

3,0mm **617-02**

4,5mm **617-03**

2,5mm **617-04**

3,0mm **617-05**

4,5mm **617-06**

3,0mm **617-08**

3,0mm **617-09**

P-LUX⁺ Bandeja + P-LUX

antes ~~533€~~
ahora **373€**
/ud.

617-100S

Incluye:
617-01 - 617-03 - 617-04
617-06 - 617-07 - 617-20
1372-11 - 2599-10





antes ~~106€~~
ahora **74'20€**



3409-1012
#1 graduation 3/6/8/11 mm,
PU 12 pieces, M4 x 0.5 mm



3409-1112
#CPG12 graduation 3/6/9/12 mm,
PU 12 pieces, M4 x 0.5 mm

3409-1005
Pack Surtido 2 de cada una de las puntas
PU 10 pieces, M4 x 0.5 mm



3409-1212
#CPNG22 graduation 2/4/6/8/10/12 mm,
PU 12 pieces, M4 x 0.5 mm



3409-1312
#PCPG 11,5 graduation 3,5/5,5/8,5/11,5,
PU 12 pieces, M4 x 0.5 mm



3409-1512
#CNC graduation in 1-15 mm steps,
PU 12 pieces, M4 x 0.5 mm

Modeladores de Composite con puntas de Titanio

ULTRA



OFERTA
5+1
MODELADORES

antes ~~46€~~
ahora **37€**
/ud.



antes ~~231€~~
ahora **159€**

4085-00Ti
Incluye Refs.:
4085-01Ti -
4085-02Ti -
4085-03Ti -
4085-04Ti -
Caja para instrumental:
2599-05

4085-01Ti
Espátula para composite
fina, Ø 1,8 / 1,5 mm,
cabezales intercambiables

4085-02Ti
Espátula para composite
fina, Ø 2,9 / 2,7 mm,
cabezales intercambiables

4085-03Ti
Plugger Pera para
composite Ø 1,5 / 2,0 mm,
cabezales intercambiables

4085-04Ti
Plugger cónica
Ø 1,8 / 1,8 mm,
cabezales intercambiables,
punta angulada para distal



4085-05Ti
Plugger bola para
composite
Ø 0,9 / 1,3 mm,
cabezales intercambiables



4085-06Ti
Plugger bola para
composite
Ø 2,1 / 1,3 mm,
cabezales intercambiables



4085-08Ti
Espátula para composite
Ø 1,7 / 1,7 mm. intercamb.
especial interproximal
mesial / distal



4085-10Ti *
Espátula para composite
Ø 1.0 mm,
muy fina y flexible



* Comprando 2 llévate de regalo un mango.

Kit avanzado micro TUNNELING 14 piezas

1790-240

Está compuesto por los siguientes instrumentos:

- 1033-60 - Mango para bisturí SAFE-EX
- 1136-17 - Tijeras micro cerrada de 17cm
- 1070-00 - Mango para hojas de micro cirugía 13cm TITANIUM
- 1208-300 - Fórceps Micro 17,5cm recto 1x2 dientes
- 1208-345 - Fórceps Cooley 18cm acero inoxidable
- 1208-355 - Pinza micro sutura
- 1705-15 - Elevador de papila SCHWERT-DESIGN
- 1705-25 - Cuchillo para tunelizar la mandíbula superior
- 1705-35 - Cuchillo para tunelizar la mandíbula inferior
- 1705-55 - Cuchillo de periodoncia Orban 1/2
- 1705-65 - Cuchillo periodoncia KGF8 modificado
- 1705-75 - Cuchillo periodoncia
- 2000-10 - Porta aguja micro recto
- 2610-1 - Bandeja con bastidores

antes
~~2.178€~~
ahora
1.525€



antes
~~278€~~
ahora
195€

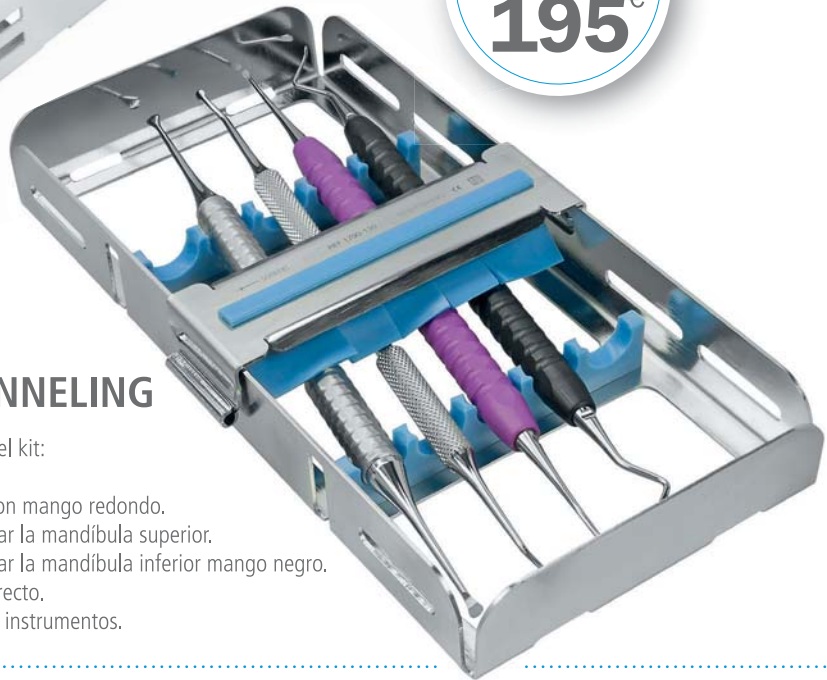

1790-130 Kit TUNNELING

Instrumental dental que incluye el kit:

- 1705-01 - Elevador de papila con mango redondo.
- 1705-02 - Cuchillo para tunelizar la mandíbula superior.
- 1705-03 - Cuchillo para tunelizar la mandíbula inferior mango negro.
- 1705-04 - Micro Flap elevador recto.
- 2599-05 - Bandeja para lavar 5 instrumentos.



Tu depósito dental de confianza

CCS Dental



T. +34 93 137 02 06 / Móv. 655 076 085
info@ccsdental.es · <https://ccsdental.es>

Facebook
CCS Dental

LinkedIn
CCS Dental

Instagram
@ccs_dental



Haga sus pedidos online a través de nuestra tienda:

www.ccsdental.es