



MIDAS 1 MILE

USER MANUAL AND
CARE INSTRUCTIONS

Rangefinder Elements

- 1 "Mode" Button
- 2 "Ranging"/"Power" Button
- 3 Eyepiece
- 4 Battery Compartments
- 5 Laser Receiving Objective
- 6 Laser Emission Objective

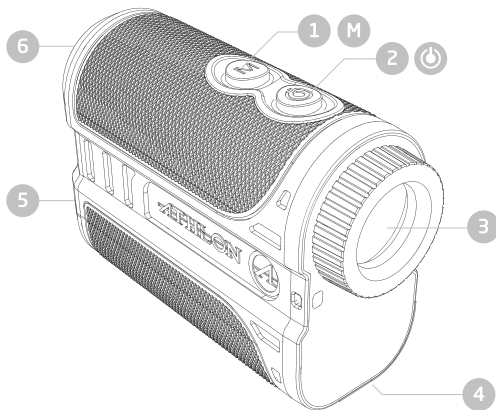



* Short press: Press less than 1 second

* Long press: Hold for 3 seconds

Startup and Shutdown

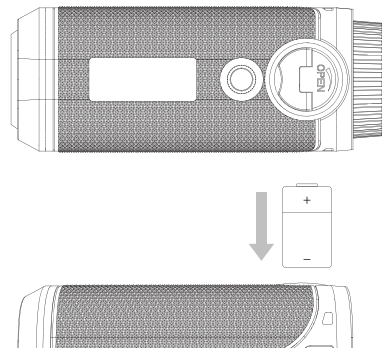
1. Remove the battery cap on the bottom and insert a CR2-3V battery into the battery chamber, having the positive side facing up, then close the battery cap.



2. Short press  button to power on. You should see the startup display by looking through the eyepiece.
3. Laser Range Finder will automatically power off after idling for more than 10 seconds.

Eyepiece LCD Display

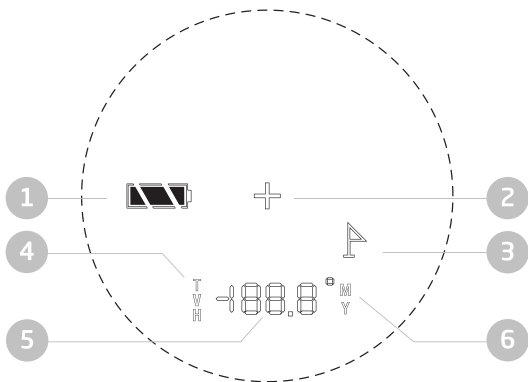

- 1 Battery Indicator;
- 2 Aiming Reticle;
- 3 Golf Function Sign
- 4 Incline Angle, Horizontal Distance, Vertical Distance Mode Sign;
- 5 Distance, Incline Angle, Mode OFF and Auto function Display
- 6 Unit: M -- Meter, Y -- Yard.

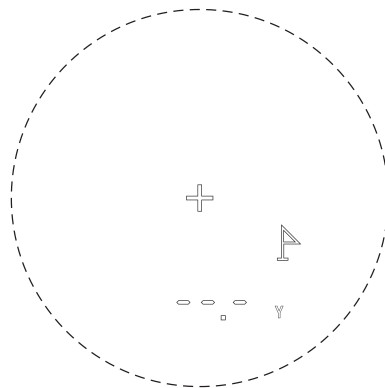

Menu Operational Flowchart

1. **Power ON:** Short press  to power on. The startup screen will display the last used mode. After 10 seconds of no-operation the display will power off automatically.



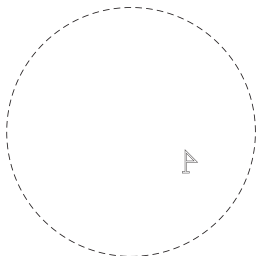

- 2. Select display mode:** While the display is active, long press  button for more than 3 seconds. Press  button to select Golf or Auto mode. Flashing icon indicates selected.

Golf Mode

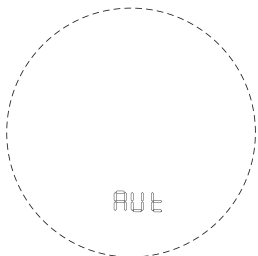

Auto Mode



Short press  to confirm the item you selected. You will automatically enter into "M/Y" selectable display.

- 3. Select measuring units:** Short press  to select "M" or "Y".

Yards

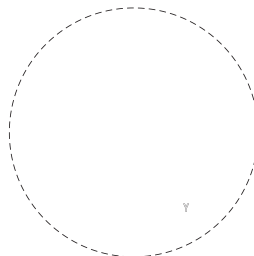

Meters

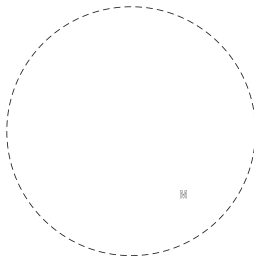

Short press  to confirm the item you selected. You will automatically enter into ranging mode display.

4. **Select ranging mode:** Short press  to select one of the following ranging modes: Incline Angle, Vertical Distance, Horizontal Distance, "OFF" No-Display.

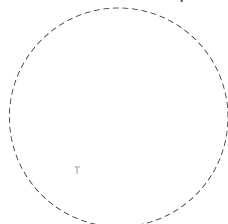

Incline Angle

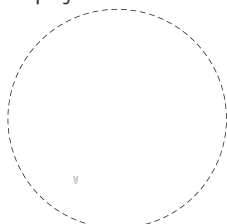

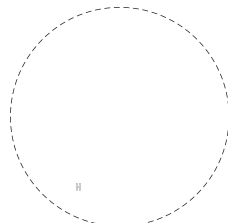

Vertical Distance

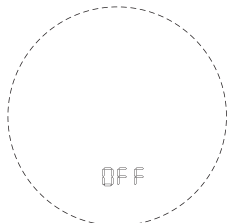

Horizontal Distance



"OFF" No-display

Short press  to confirm the item you selected. To confirm all changes long press  to save and go back to the ranging display. Set up is now complete.

5. **Low battery indication:** When the voltage is lower than 2.7V, "LOW BATTERY" sign will appear and blink as below, the blink interval is 1s, and will blink for 5 seconds and then power off automatically.

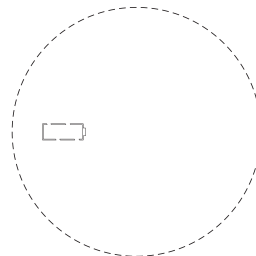

Ranging Modes to Choose From

Incline Angle (T) mode displays the incline angle of your position to the target.

Horizontal Distance (H) mode displays the angle compensated distance to the target. This is the primary mode used by most hunters (Both bow and rifle).

Vertical Distance (V) mode displays the vertical distance of your position to the target.

Scan mode feature displays distance readings quickly as you pan across a target, landscape or a moving animal.

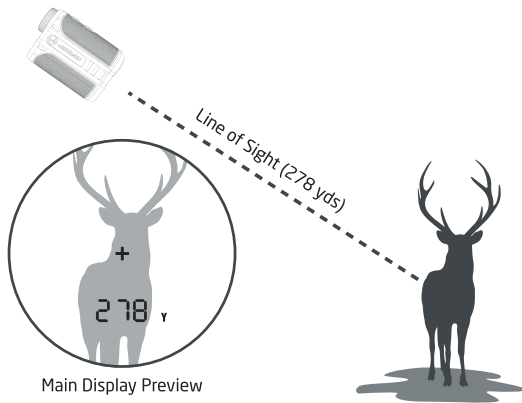

** Scan mode feature only available in Horizontal Distance and Vertical Distance ranging modes*



THE ATHLON GOLD MEDAL LIFETIME WARRANTY*

Your Athlon product is not only warranted to be free of defects in materials and workmanship for the lifetime of the product. Athlon will also repair or replace, at no charge to you, your product if you should damage it through normal use. No receipt is needed, no registration is required. This is a commitment that Athlon Optics will be the best product you can buy for your money.

**This warranty does not cover damages caused by deliberate damage, misuse, theft or maintenance provided by someone other than the Athlon Authorized Service Department.*



TOLL FREE: 1-855-913-5678



CONTACT@ATHLNOPTICS.COM



801 N MEADOWBROOK DR, OLATHE, KS 66062