



ATHLON
OPTICS



MIDAS 1200Y

USER MANUAL AND
CARE INSTRUCTIONS

Rangefinder Elements

- 1 "Mode" Button
- 2 "Ranging"/"Power" Button
- 3 Eyepiece
- 4 Battery Compartments
- 5 Laser Receiving Objective
- 6 Laser Emission Objective

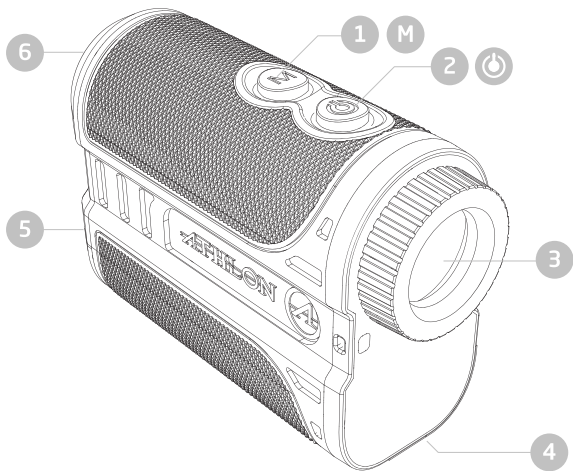

Startup and Shutdown

1. Remove the battery cap on the bottom and insert a CR2-3V battery into the battery chamber, having the positive side facing up, then close the battery cap;

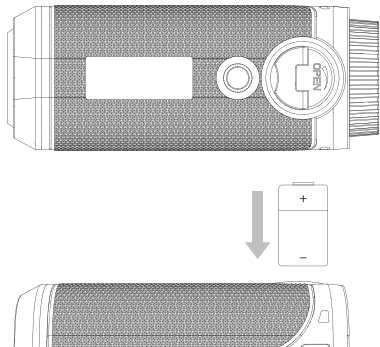

2. Short press the "Power" button to power on. You should see the startup display by looking through the eyepiece;
3. Laser Range Finder will automatically power off after idling for more than 25 seconds.

Eyepiece LCD Display

- 1 Unit: M--Meter, Y--Yard;
- 2 Unit: M--Meter, Y--Yard;
- 3 Secondary Display: Incline Angle, Vertical Distance, True Horizontal Distance;
- 4 Aiming Reticle;
- 5 Low Battery Indicator;
- 6 Sight Distance Display, "----" represents that target cannot be measured.

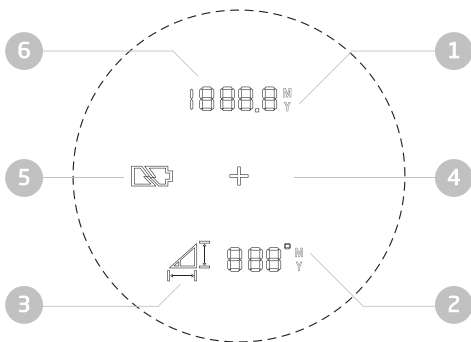

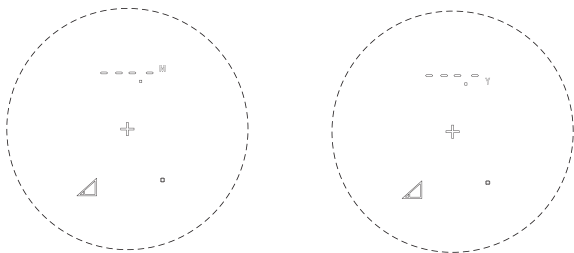

Menu Operational Summary

1. **Power ON:** Press  to power on, LCD will display as following:



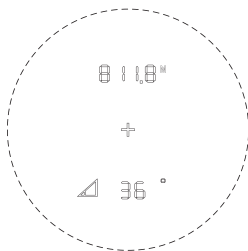

2. **Ranging:** Short press "Ranging" button  shortly, the range reading is displayed as below:

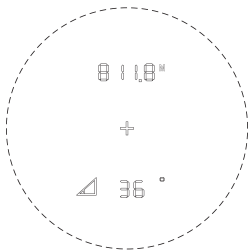

- Scanning Mode:** Holding the “Ranging” button  and skimming among different targets the Rangefinder will scan a group of measurable targets at different distances and give you constant readings of different angular and distance information.



- Change Unit of Measurement:** Holding the “Mode” button , and then within 2 seconds short press the “Ranging” button  to change the unit between meter and yard.
- Change Secondary Display:** After the unit is powered ON at normal ranging mode, short press the “Mode” button  to switch among different measurement displays that include incline angle, vertical distance, true horizontal distance.

Incline Angle

$$\begin{array}{r} 811.8'' \\ + \\ \triangle 36^\circ \end{array}$$

Vertical Distance

$$\begin{array}{r} 811.8'' \\ + \\ \triangle 477'' \end{array}$$

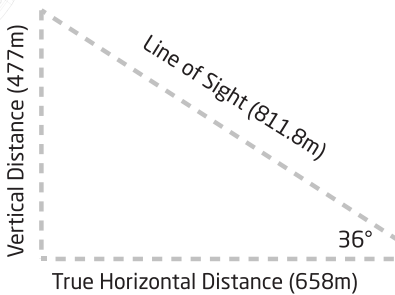

True Horizontal Distance

$$\begin{array}{r} 811.8'' \\ + \\ \triangle 658'' \end{array}$$

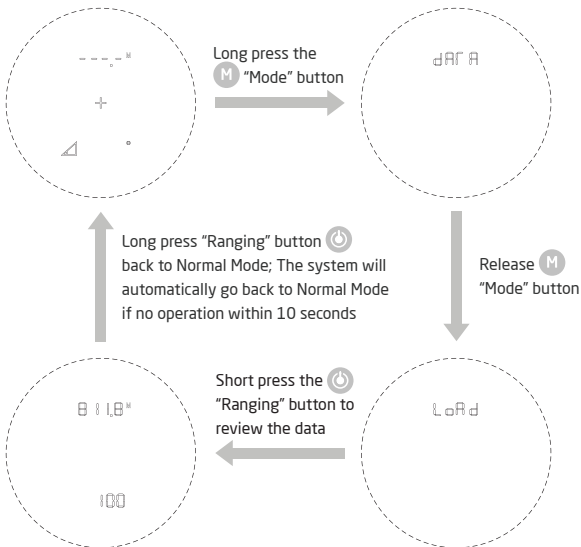

6. **Memory Mode:** Long press the “Mode” button **M** to switch from Normal Mode (N) to Memory Mode (M) (see the illustration below).



-
- 1) Maximum reading data up to 100 sets;
 - 2) Short press "Ranging" button  for page up, short press "Mode" button  for page down;
 - 3) Enter Memory mode, the default display is the last date, that is the 100th data, and the system will overwrite the oldest data set.

THE ATHLON GOLD MEDAL LIFETIME WARRANTY*

Your Athlon product is not only warranted to be free of defects in materials and workmanship for the lifetime of the product. Athlon will also repair or replace, at no charge to you, your product if you should damage it through normal use. No receipt is needed, no registration is required. This is a commitment that Athlon Optics will be the best product you can buy for your money.

** This warranty does not cover damages caused by deliberate damage, misuse, theft or maintenance provided by someone other than the Athlon Authorized Service Department.*





TOLL FREE: 1-855-913-5678



CONTACT@ATHLONOPTICS.COM



14308 W 96TH TERRACE LENEXA, KS 66215