

## Specification

Height	120 mm (4.72 ")
Quick shoe Diameter	56 mm (2.2 ")
Body Diameter	62 mm (2.44 ")
Weight	760 g (1.68 lbs)

## Operating Instructions

Thank you very much for choosing SLIK SBH-808DQ. SLIK Corporation has designed your pan head to be a sturdy, rugged, dependable product that will provide you with many years of satisfactory use.

Please take a few moments to read this operating instruction carefully before use so that you can take full advantage of your Pan head's many fine features.

Retain this operating instruction in case you might want to refer back to it.

### ⚠ Caution

This caution icon refers to information pertaining to important safety procedures in preventing injuries, or damages which may occur as a result of mishandling this product.

### 🚫 Prohibition

This prohibited icon refers to information pertaining to prohibited contents. Please refer to instructions closely to avoid accidents.

Q723

## Components

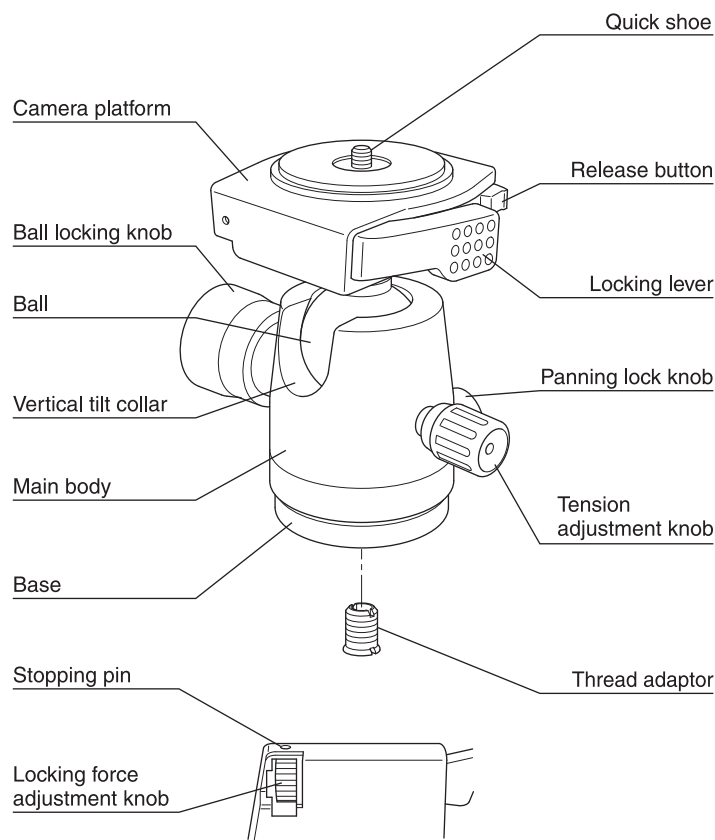

## Options

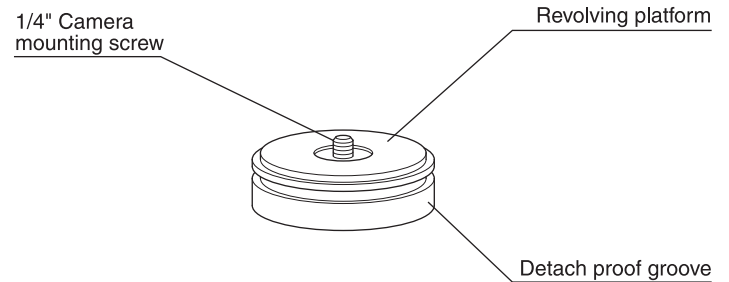

## Equipment that can be loaded on this tripod

### ⚠ Caution

### 🚫 Prohibition

This product has been designed to handle equipment weighing under 5 kgs (11.0 lbs).

Do not overload.

Some equipments weighing under 5 kgs (11.0 lbs), such as long lenses, may not balance well due to its weight distribution.

In such case, select a larger tripod.

## Setting up

### ⚠ Caution

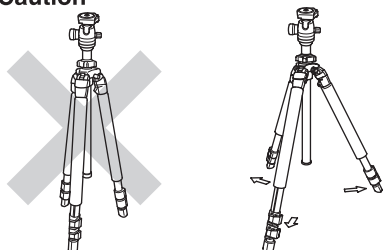

To prevent accidental equipment fall or tripod tipping over making sure all levers, knobs and handles on the tripod are securely tightened, and all three legs are opened all the way.

## Carrying the tripod

### 🚫 Prohibition

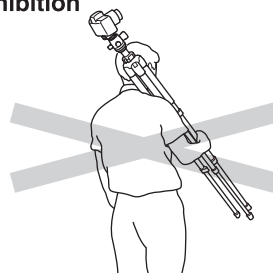

Carrying a tripod with a camera left on can result in unexpected accidents. We therefore, recommend you to remove your camera while carrying the tripod.

## Attaching to a Tripod

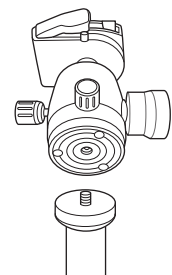

Adjust threaded post socket to the appropriate thread size of your tripod screw. Remove the thread adaptor if your tripod thread is 3/8". Remember to lock the panning lock knob before tightening.

## Attaching the camera

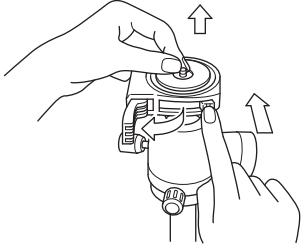

1. Remove the quick shoe by opening the locking lever and then pressing the release button.

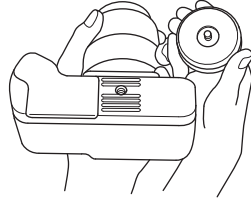

2. Screw the quick shoe on to camera, and insert back into the camera platform.

**⚠ Caution**

Please do not over tight your quick shoe.

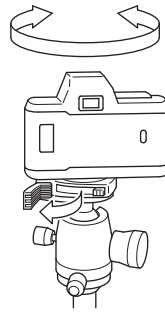

3. Correctly installed you will hear a "click", and the quick shoe will rotate 360°.

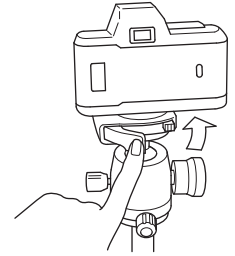

4. Fix the quick shoe at a desired position by closing the locking lever.

5. To remove the quick shoe, follow step 1.

## To lock camera platform

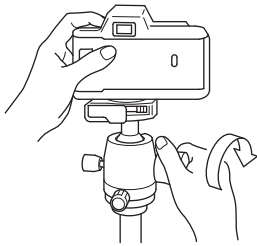

The camera platform can be locked into the position by the tightening the ball locking knob.  
Make sure to hold your camera while operating the ball locking knob.

**⚠** Do not take off ball locking knob, to prevent dropping out the inner part.

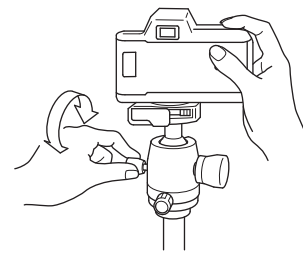

By turning the tension adjustment knob (located opposite of the ball locking knob), you can adjust the tension of the ball movement. Make sure to hold your camera while operating the tension adjustment knob. Make adjustments after loosening the locking knob slightly, so as to free the ball movement.

## Shooting at a vertical position

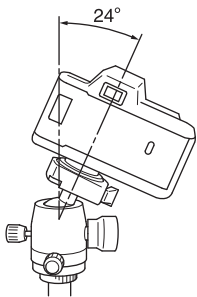

The camera platform will normally tilt down 24°.

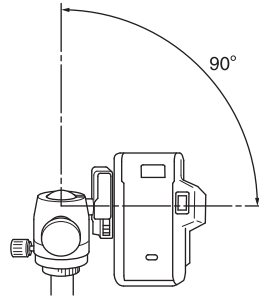

By using the vertical tilt collar, it will tilt down further to 90°.

## Safeguards during operation with a camera

**⚠ Caution**

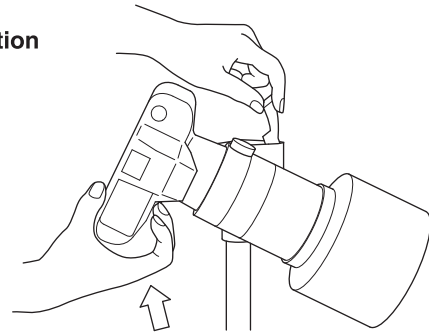

The camera can fall suddenly when the ball locking lever or locking lever is loosened, causing damages and injuries. Always hold on to the camera during such operation.

## Adjusting the firmness of the locking lever

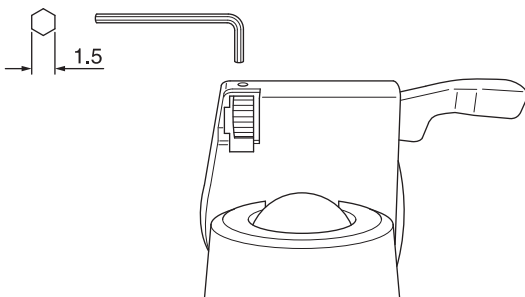

Over a long usage, the firmness of the locking lever may yield slightly. In such case, it is possible to make re-adjustments with the locking force adjustment knob.

Use a 1.5mm hexagon wrench to loosen the stopping pin.

## Care of the tripod

- DO NOT apply any grease or oil to this product.
- Clean with a mild detergent and a soft cloth only.
- DO NOT use close to flame. Avoid extreme heat.



Slik corporation reserves the right to make changes in design and/or improvements on the products without any obligation and advanced notice.

SLIK CORPORATION

853 Kayama, Hidaka City, Saitama 350-1231, Japan  
Phone 81-42-989-2141, Fax. 81-42-985-0210 ©2013