

Reversible threaded post

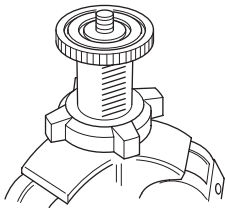

1. The threaded post on the upper end of the center column is 3/8". The threaded post on the lower end of the center column is reversible, 1/4" and 3/8". If 1/4" post is needed at the top, reverse the center column itself (see "Using the short center column")

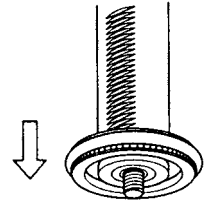

2. To reverse a post, first loosen the base plate. Then remove the post, reverse it, and reinsert it. Retighten the base plate. Note: When reversing the lower threaded post, move the rubber ring up first.

Short Center Column

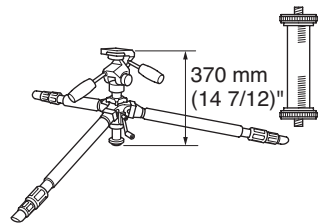

- For the lowest possible camera angle with the legs fully spread, a special short center column is available as an optional accessory.* This makes the lowest position 370 mm (14 7/12") from the ground.

Using the short center column

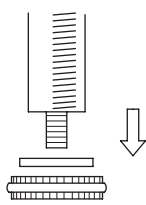

1. Remove the lower base plate and the rubber ring.
2. Loosen the center column tension adjustment knob and nut three or four complete turns.

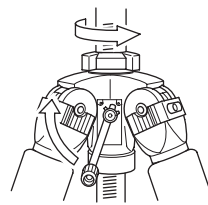

3. Using the elevation control handle, crank out the center column, while holding on to the head.
4. Remove the rubber ring and lower base plate from the short center column.

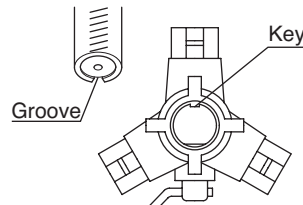

5. Match the groove of the short center column to the Key guide inside the body of the tripod. Check to be sure this is perfectly matched.
6. Turn the elevation control handle to engage the gear on the short center column. **Check to be sure operation is smooth.**

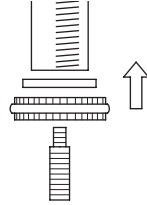

7. Replace the rubber ring and base plate.
8. Be sure to attach the rubber ring and base plate to the center column that you just removed to prevent loss.

Adjustment of center column play (after using tripod)

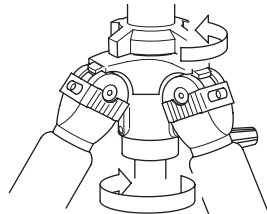

Adjustment of the center column play can be accomplished by locking a screw with the enclosed allen wrench.

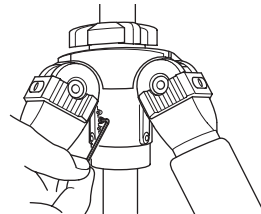

2. Insert enclosed allen wrench into wrench hole and tighten the screw.

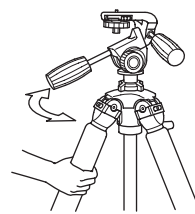

3. Turn the elevation control handle to check the tightness of the center column. Also check for any play by moving the head while keeping the legs steady.
4. If the center column is too tight, use the allen wrench to loosen the screw and adjust.

Options

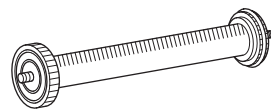

SHORT CENTER COLUMN FOR PROFESSIONAL II

Care of the Tripod

- DO NOT apply any grease or oil to this product.
- Clean with a mild detergent and a soft cloth only.
- DO NOT use close to flame. Avoid extreme heat.

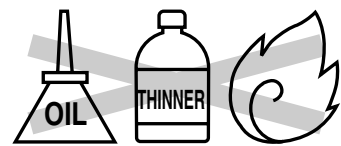

Slik corporation reserves the right to make changes in design and/or improvements on the products without any obligation and advanced notice.

SLIK®

PROFESSIONAL II -LE

Operating Instructions

Congratulation on the purchase of a SLIK Professional II -LE. SLIK Corporation has designed your tripod to be a sturdy, rugged, dependable product that will provide you with many years of satisfactory use.

Please take a few moments to read this operating instruction carefully before use so that you can take full advantage of your Tripod's many fine features. Retain this operating instruction in case you might want to refer back to it.

⚠ Caution

This caution icon refers to information pertaining to important safety procedures in preventing injuries, or damages which may occur as a result of mishandling this product.

🚫 Prohibition

This prohibited icon refers to information pertaining to prohibited contents. Please refer to instructions closely to avoid accidents.

Specification

Folded length	810 mm (31 11/12")
Max. operating height	1,835 mm (72 1/4")
Max. center column ext.	285 mm (11 1/4")
Weight	4.9 kg (10lbs 13oz)

G079-1

Components

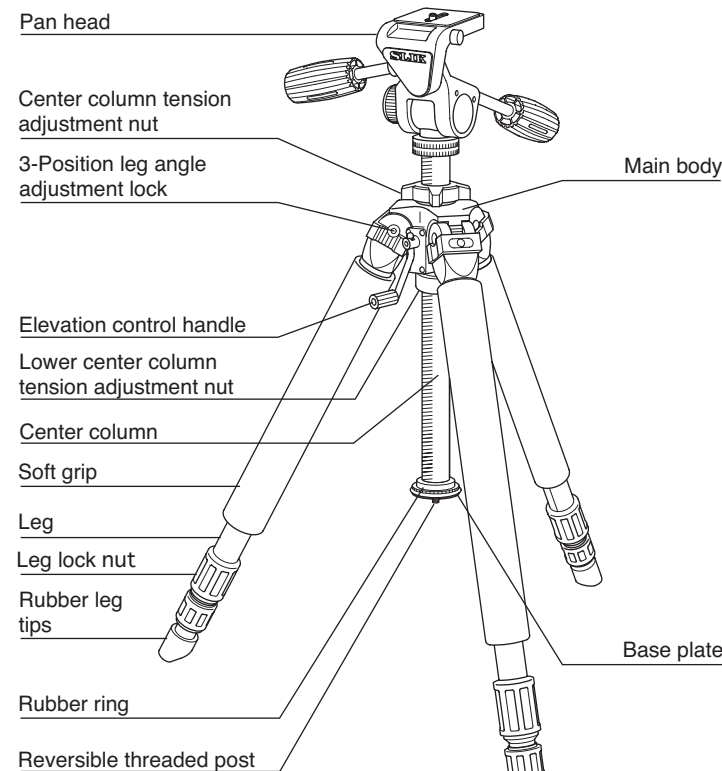

Pan head

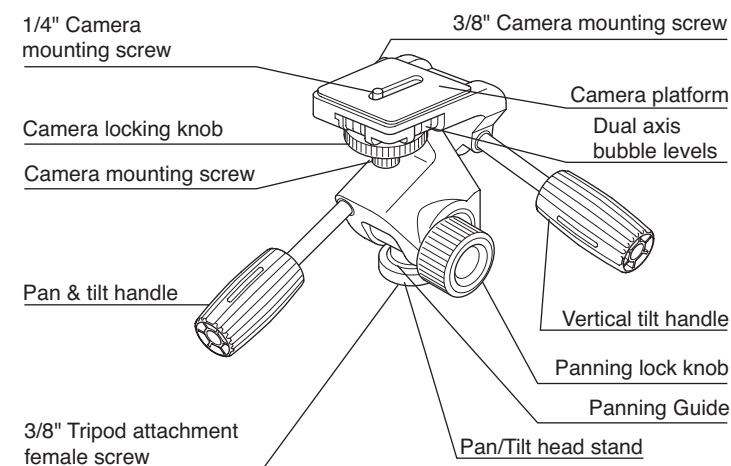

Accessory

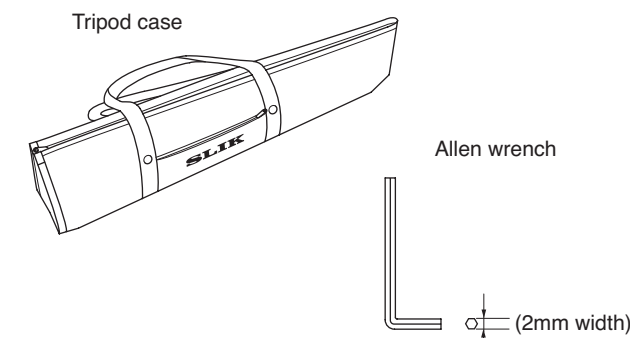

⚠ Caution

Soft Grip is consumption and cannot be used permanently. Please replace it whenever ragged.

Pan head attachment screw

🚫 Prohibition

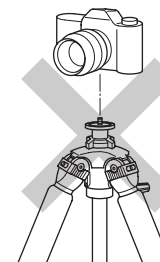

Do not attach a camera directly to the pan head attachment screw of the center column. This may damage both your camera and tripod.

Carrying the tripod

🚫 Prohibition

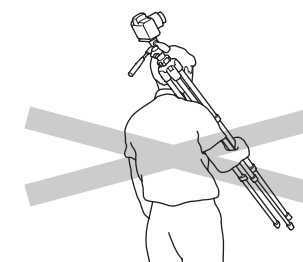

Carrying a tripod with a camera left on can result in unexpected accidents. We therefore, recommend you to remove your camera while carrying the tripod.

Equipment that can be loaded on this tripod

🚫 Prohibition

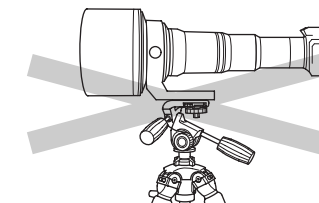

This product has been designed to handle equipment weighing under 10 kgs (22 lbs). Do not overload. Some equipments weighing under 10 kgs (22 lbs), such as long lenses, may not balance well due to its weight distribution. In such case, please use a larger tripod.

Install the pan handles

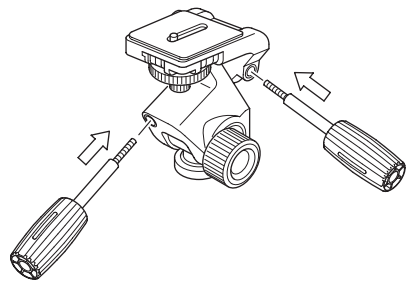

The pan handles are installed as shown with the long handle on the left, for pan and tilt movement; the short on the right, for vertical tilt. If you prefer to have it the other way around, the tripod will function perfectly.

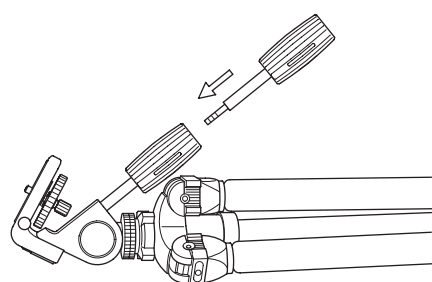

The vertical & tilt handle can be reset inside the pan & tilt handle by screwing from rear of the handle as shown here.

Attach the head

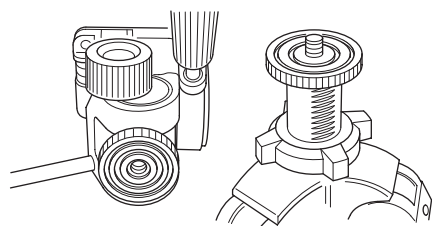

The head is installed by screwing it onto the center column's 3/8" threaded post socket hole.

Using the pan head

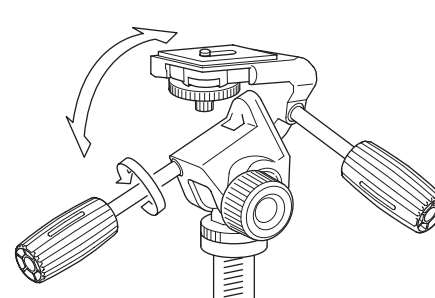

1. Loosen the panning handle, and the head will move freely front to rear.

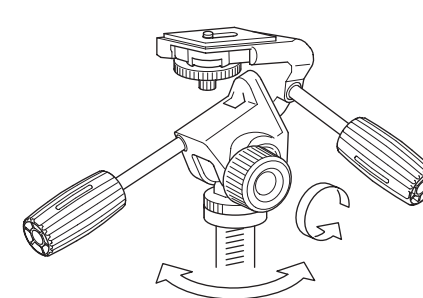

2. Loosen the panning lock knob, and the head will rotate.

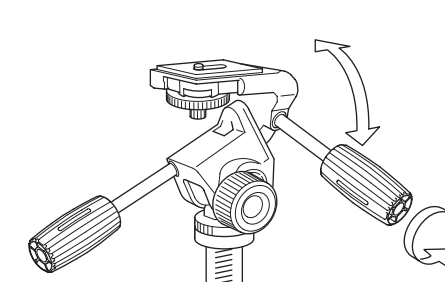

3. Loosen the vertical tilt handle and the level can be adjusted. The pan head is specially lubricated for smooth movement.

Attaching the head to the center column

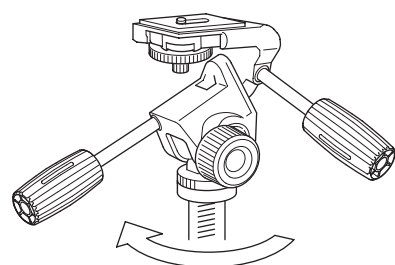

Loosen the panning lock knob and rotate the base of the head clockwise to screw it tightly onto the center column. Tighten the panning lock knob and turn the head clockwise, using both handles, to tighten as much as possible. Unlock the panning lock knob for easy panning.

Removing the head from the center column

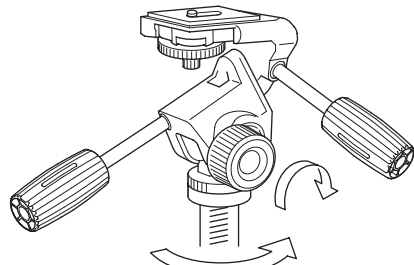

Lock the panning lock knob tightly, then grasp the pan handle and turn the head counter-clockwise to loosen. Then loosen the panning lock knob and it will be easy to unscrew the head by rotating the base of the head counterclockwise.

Panning guide

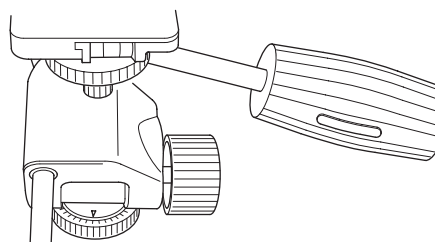

A rotating scale at the base of the head makes it easy to set exact shooting angle. To begin, set the mark at the base of the head on "0".

Three-position adjustable legs

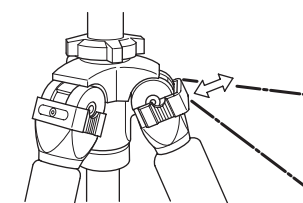

1. When opening each leg, it will stop at the first (standard) position. To change the angle of each leg, move the leg a little closer to the center column and pull the leg angle adjustment lock out one click. The leg will be released and can be opened to the second position. To move to the third position, again pull the leg angle adjustment lock out one click.

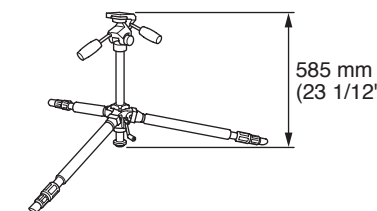

2. After choosing the desired leg angle, securely push in the adjustment lock. When all legs are opened fully, the lowest position is 585 mm (23 1/16") from the ground. An optional short center column* permits shooting as low as 370 mm (14 7/16").

Attaching a Camera

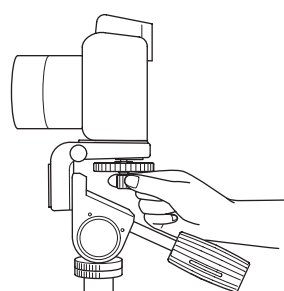

1. Hold the camera firmly, and turn the camera mounting screw to engage the threads.

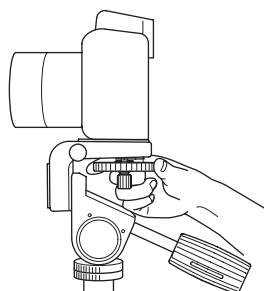

2. Lock the camera tightly with the knurled camera locking knob.

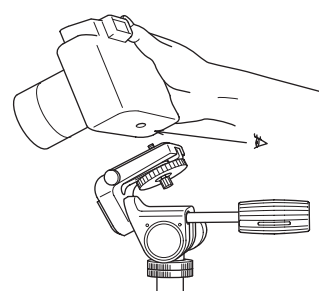

3. Tilting the head forward makes it easier to attach the camera.

Extending legs

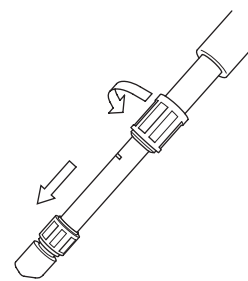

1. Release the leg locks by rotating one half turn. Because leg are grooved, the leg locks can be released in any order.

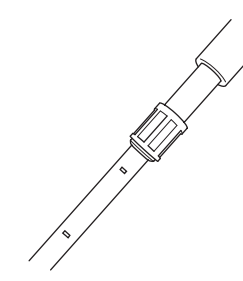

2. The second section, from the top, in each leg has reference marks every 10 cm for precise height adjustment.

Positioning the elevation control handle

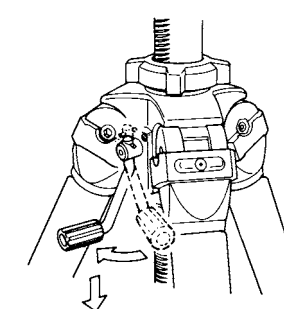

Raise the elevation control handle into position by pulling out on the knob to lock it into place.

Changing the camera mounting screw

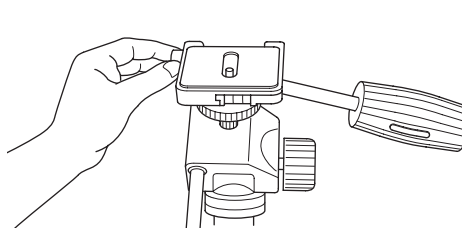

1. Both 1/4" and 3/8" camera mounting screws are supplied. The screw not in use is stored in the side of the camera platform.

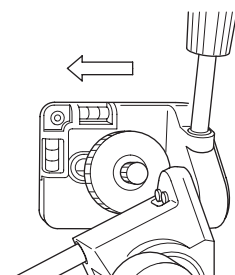

2. Remove the camera mounting screw through the large end of the mounting track. It's a good idea to tighten the camera locking knob when a camera is not attached to prevent loss of the mounting screws.

Bubble Levels

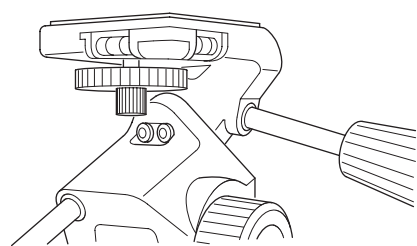

Two bubble levels are built-in for vertical and horizontal positioning.

Operating the center column

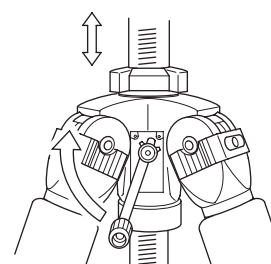

1. The center column can be moved up and down by turning the elevation control handle. The center column tension adjustment knob adjusts the tightness of the column and helps prevent vibration.

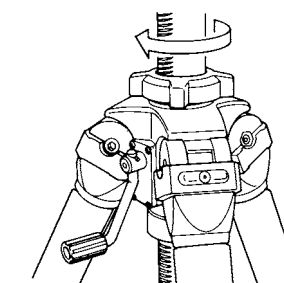

2. The worm gear column adjustment mechanism will not move even if pressure is placed on the head with the tension adjustment knob unlocked. Note-the column can be moved, with the elevation control handle, even when the tension adjustment knob is fully locked.

Lower Center Column Tension Adjustment Nut

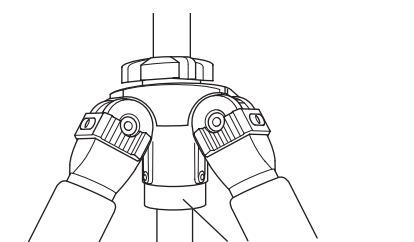

The lower center column tension adjustment nut is used when necessary to adjust the tightness of the center column.