

Extending the tripod legs

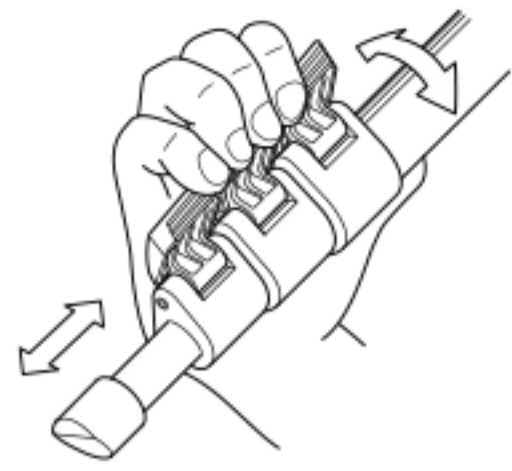

Flip up the leg lock lever to extend or shorten any of the individual leg sections to the desired length and press the leg lock lever flush against the leg to lock.

It is easier to extend the tripod legs if you turn the leg-tips to the foot, while leaving legs close.

Operating the center column

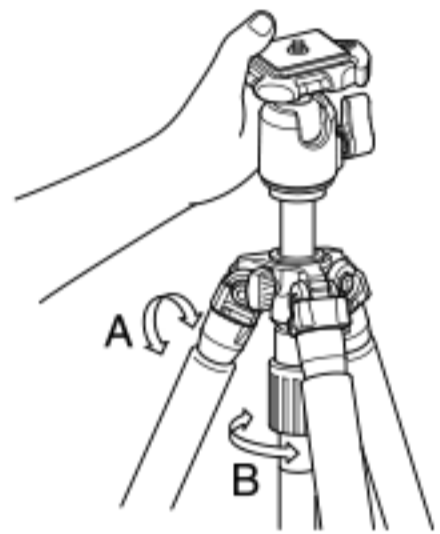

A - Screw-type
Center column stopper is used to lock or unlock center column.
B - Twist-type
Center column locking nut is used to adjust a tension of the movement.
The both of A and B must be locked for fixing center column.

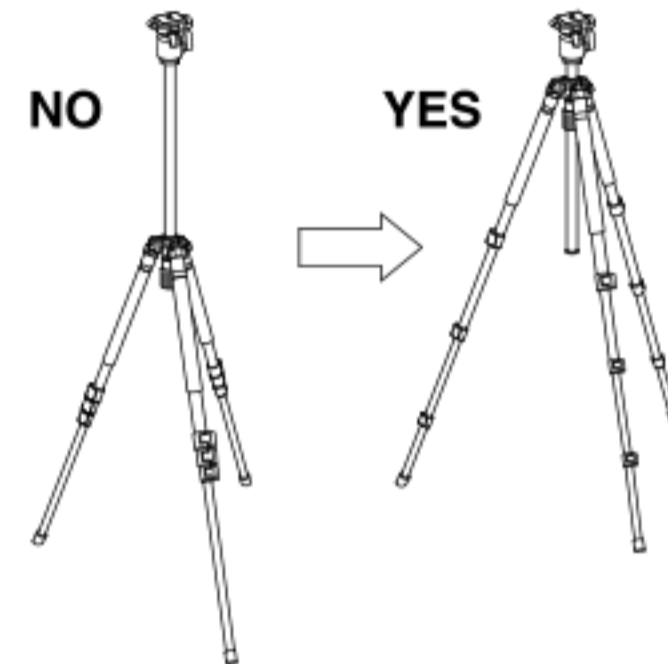

To avoid unnecessary camera vibrations, try to keep the center column height to a minimum. Also use the larger legs first when extending the legs.

How to get low position shots

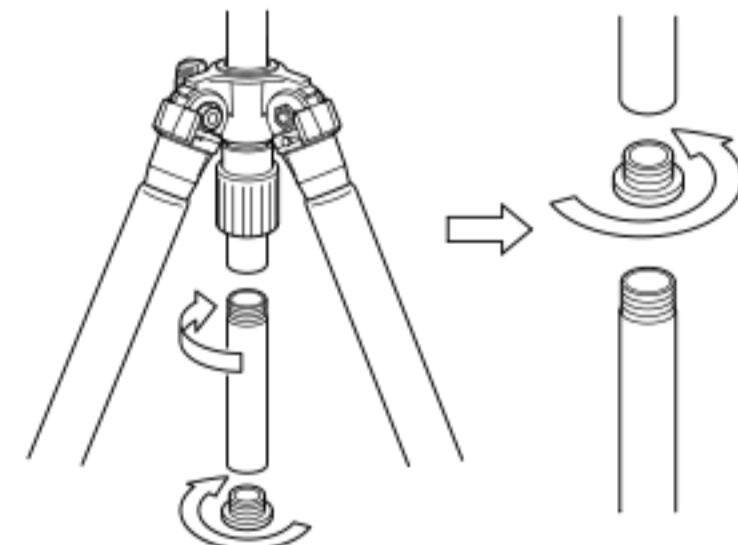
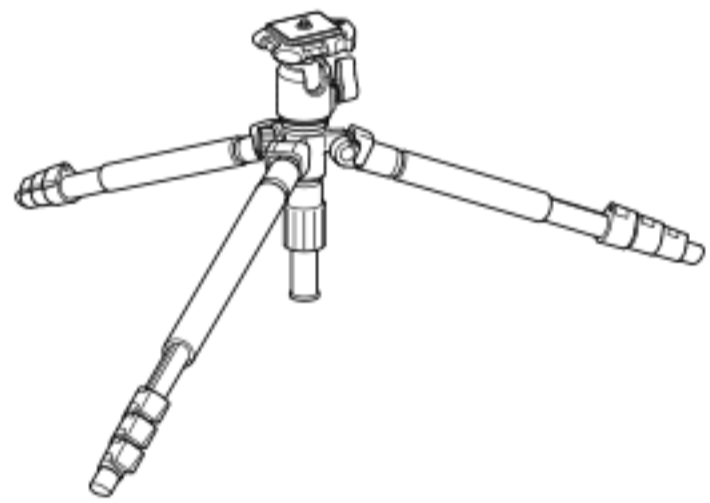

Remove the center column base stopper and then, remove the lower part of center column. Put the center column base stopper on the upper part of center column.

Care of the tripod

- DO NOT apply any grease or oil to this product.
- Clean with a mild detergent and a soft cloth only.
- DO NOT use close to flame. Avoid extreme heat.



SLIK®

PRO 340BH Tripod

Specification

Max. operating height	1,437 mm (56 1/2")
Folded length	515 mm (20 1/4")
Max. center column ext.	290 mm (11 5/12")
Weight	1,510 g (3lbs 5oz)
Tripod attachment	(1/4" &/or 3/8" female screw)

Operating Instructions

Thank you very much for choosing SLIK PRO 340BH Tripod. The SLIK Corporation has designed your tripod to be a sturdy, rugged, dependable product that will provide you with many years of satisfactory use.

Please take a few moments to read this operating instruction carefully before use so that you can take full advantage of your tripod's many fine features.

Retain this operating instruction in case you might want to refer back to it.

⚠ Caution

This caution icon refers to information pertaining to important safety procedures in preventing injuries, or damages which may occur as a result of mishandling this product.

🚫 Prohibition

This prohibited icon refers to information pertaining to prohibited contents. Please refer to instructions closely to avoid accidents.

K488-3

Components

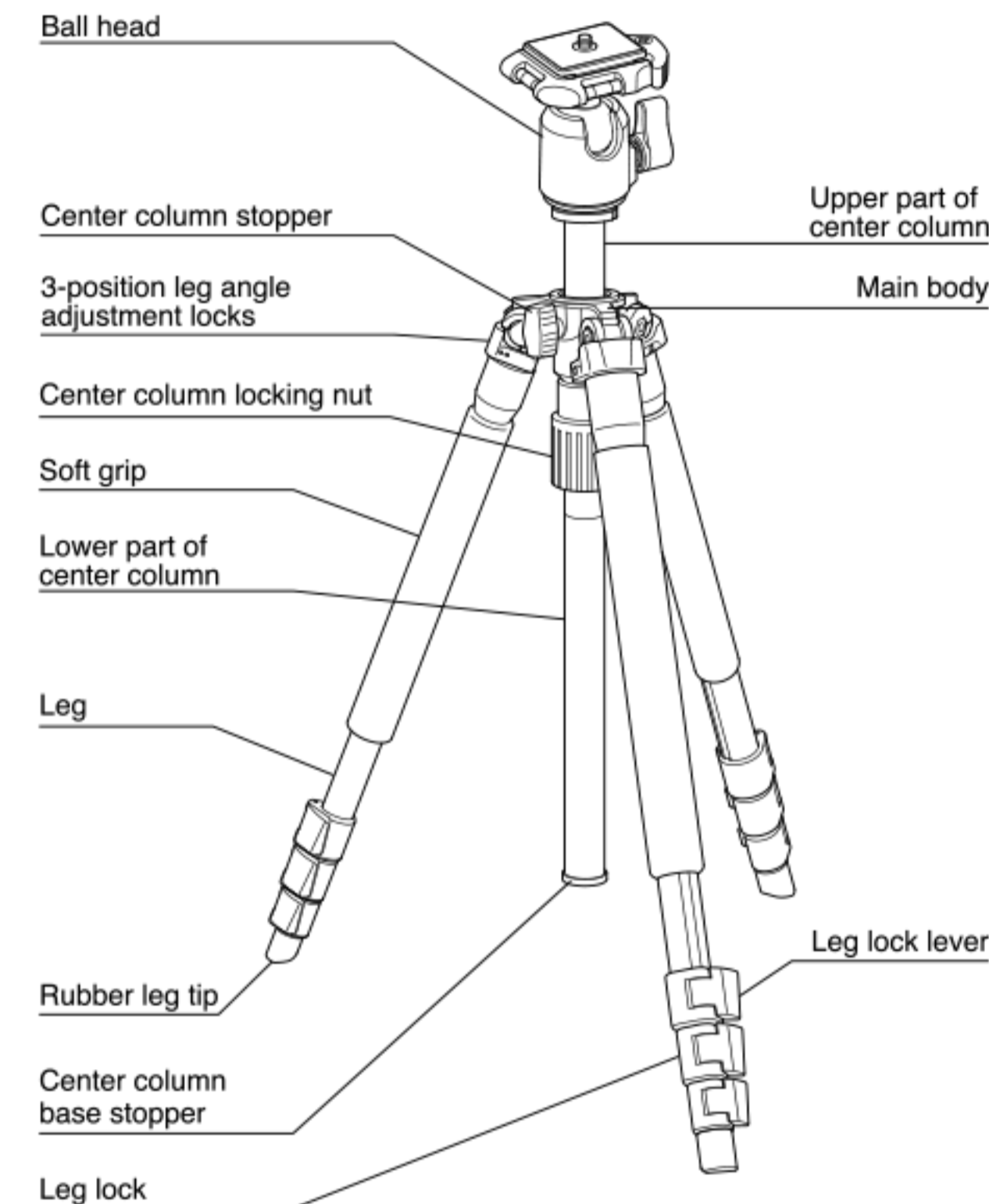

Ball head

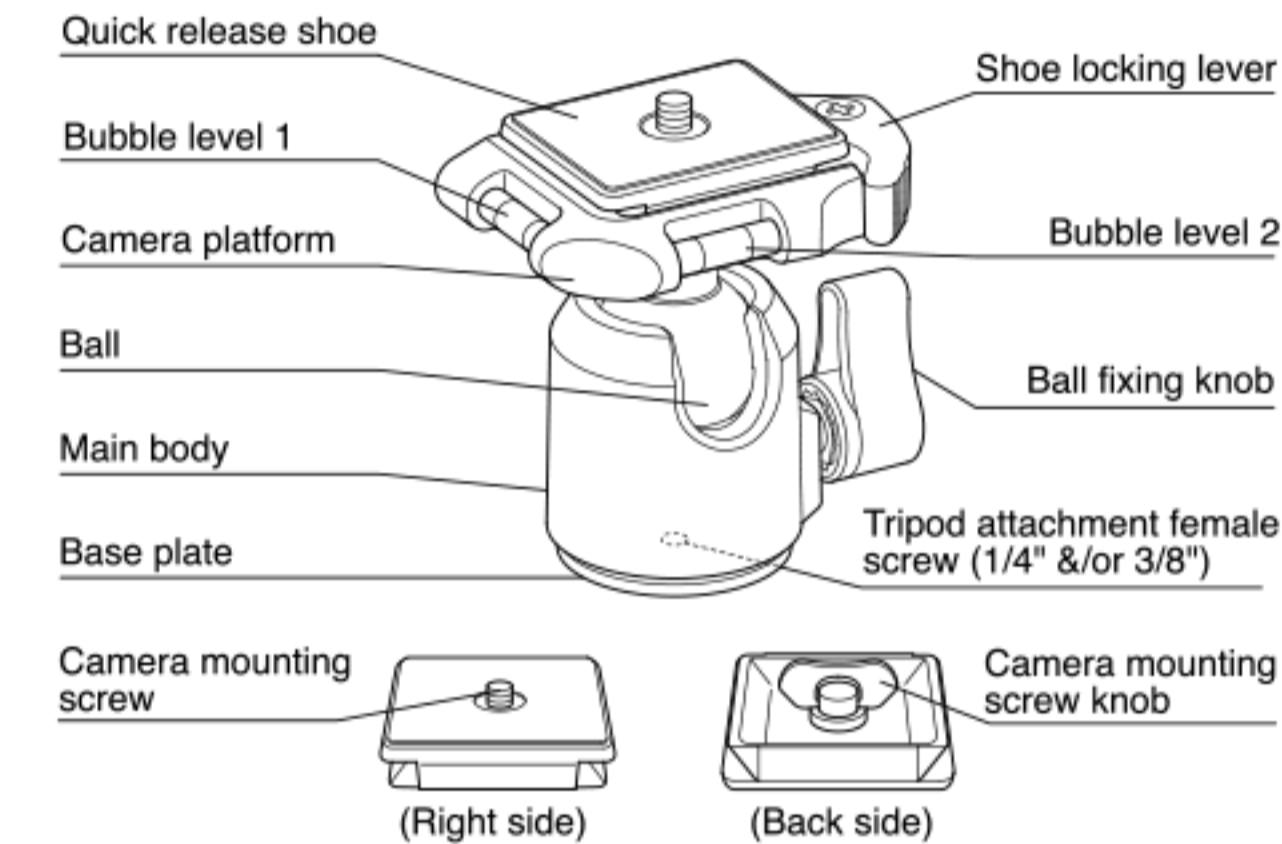

Equipment that can be loaded on this tripod

🚫 Prohibition

This product has been designed to handle equipment weighing under 3kgs (6lbs 9oz). Do not overload. Some equipment weighing under 3kgs (6lbs 9oz), such as long lenses, may not balance well due to its weight distribution. In such case, please use a larger tripod.

Carrying the tripod

🚫 Prohibition

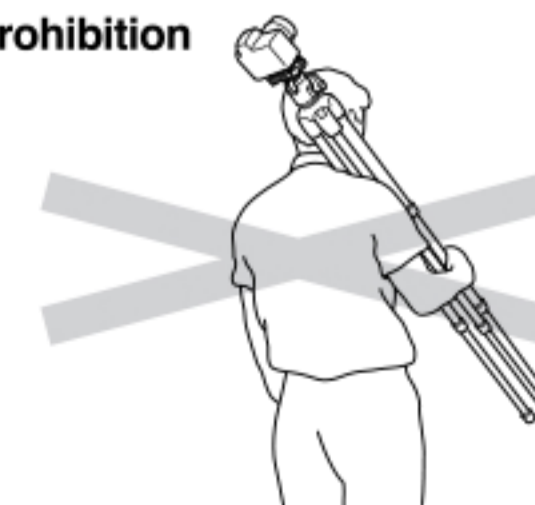

Carrying a tripod with a camera left on can result in unexpected accidents. We therefore, recommend you to remove your camera while carrying the tripod.

Setting up

⚠ Caution

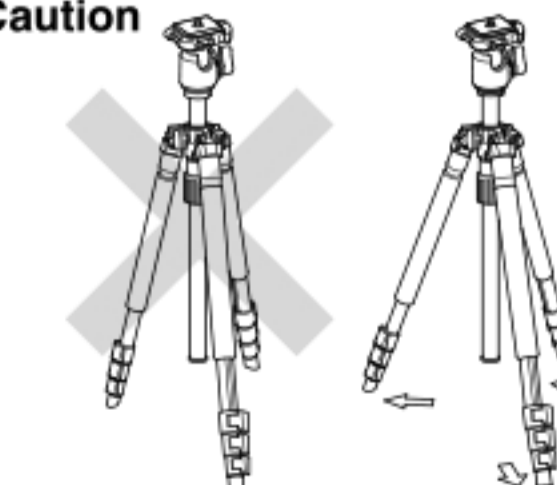

To prevent accidental equipment fall or tripod tipping over, making sure all levers, knobs and handles on the tripod are securely tightened. And all of the three legs are opened all the way.

Pan head mounting post

🚫 Prohibition

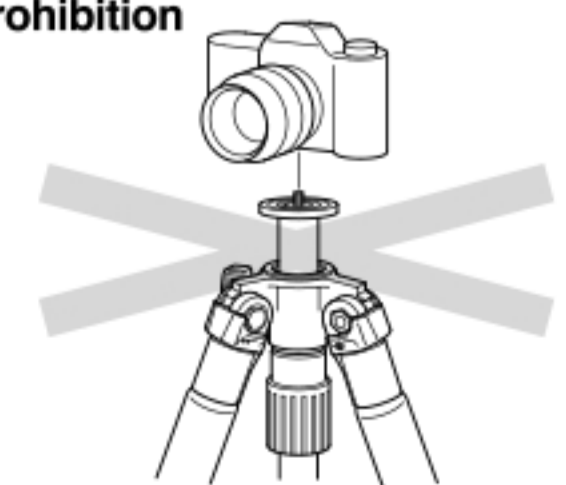

Do not attach a camera directly to the attachment screw of the center column. This may damage both your camera and tripod.