

# Sophia

SITS



# Sophia

UPHOLSTERY

COMFORTS

COVERS

SPECIAL



fabric



STD standard



LUX lux



CLS classic



FC fixed



modular system

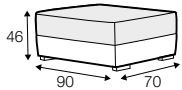

footstool 90x70

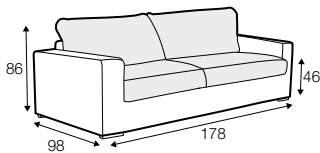

2 seater

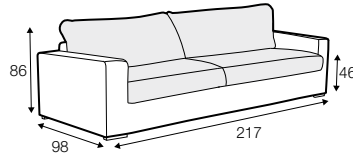

3 seater

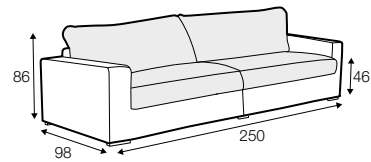

4 seater divided

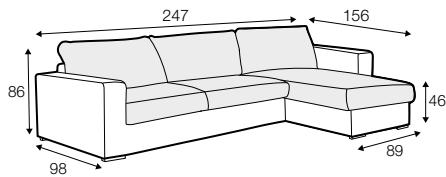

set 1 right / or left  
2 seater left / or right  
+ chaiselongue right / or left

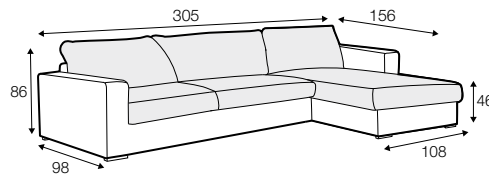

set 2 right / or left  
3 seater left / or right  
+ chaiselongue wide right / or left

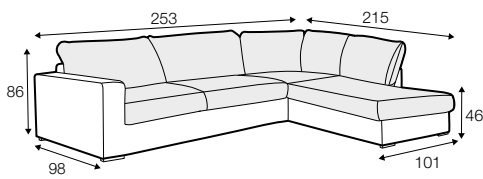

set 3 right / or left  
2 seater left / or right + divan right / or left

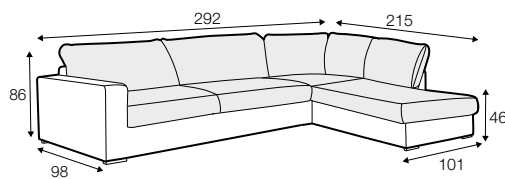

set 4 right / or left  
3 seater left / or right + divan right / or left

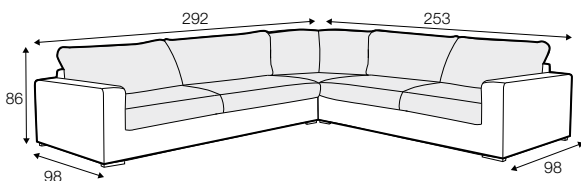

set 5 right / or left  
3 seater left / or right + corner 90°  
+ 2 seater right / or left

## modular system

---

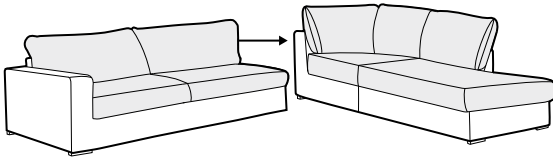

## elements of the modular system

---

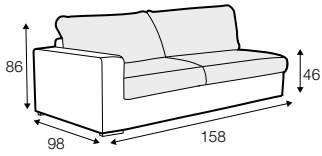

2 seater left / or right

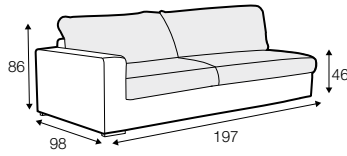

3 seater left / or right

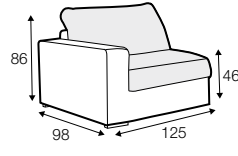

element 125 left / or right

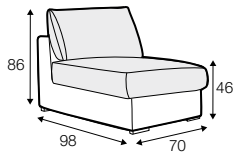

armchair without  
armrests

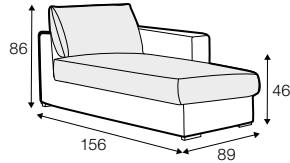

chaiselongue right / or left

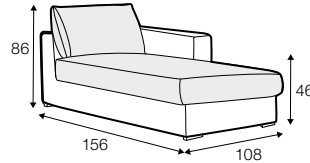

chaiselongue wide  
right / or left

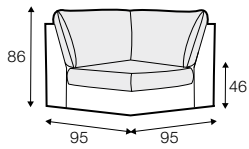

corner 90°

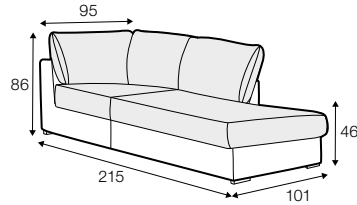

divan right / or left

## extra dimensions

---

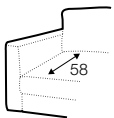

depth of seat

## accessories

---

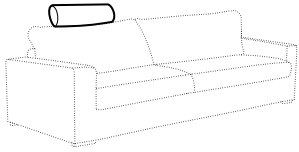

headrest L-62

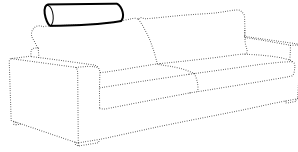
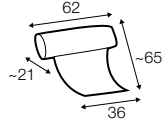

headrest L-77

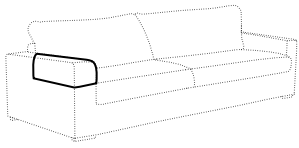
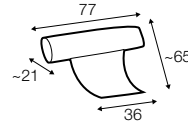

armrest protection

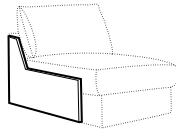

endpart left / or right

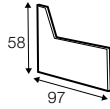

## legs

---

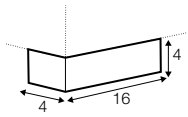

no. 132  
wood

## profile

---

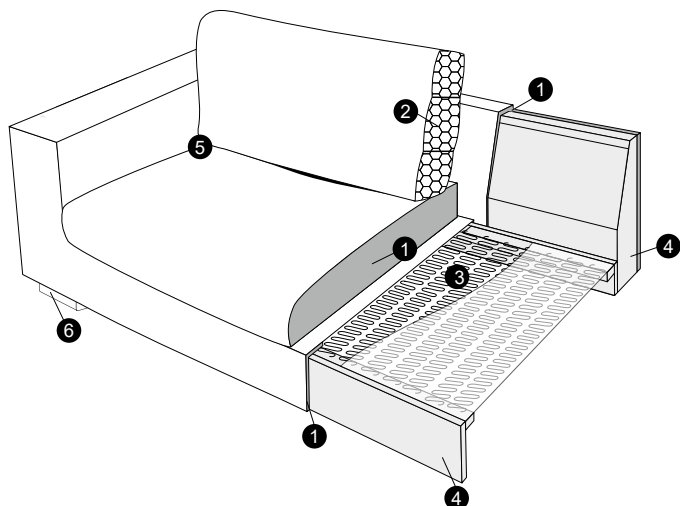

### standard

1. polyurethane foam / high resilient polyurethane foam
2. silicone balls
3. springs
4. solid wood and wood based elements
5. fabric
6. solid wood legs

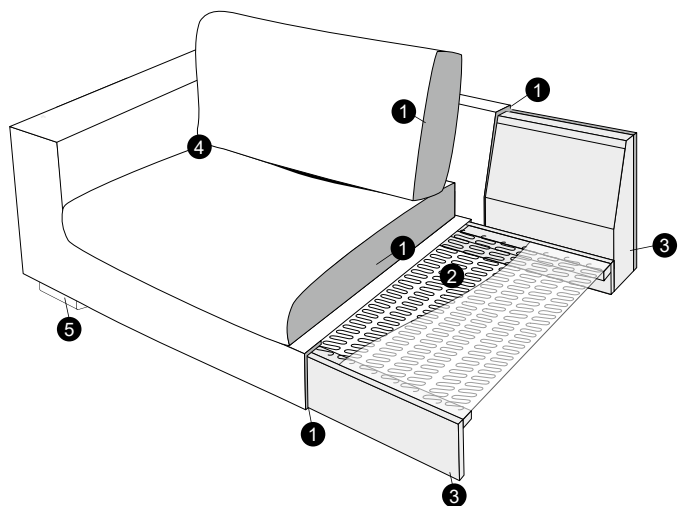

### classic

1. polyurethane foam / high resilient polyurethane foam
2. springs
3. solid wood and wood based elements
4. fabric
5. solid wood legs

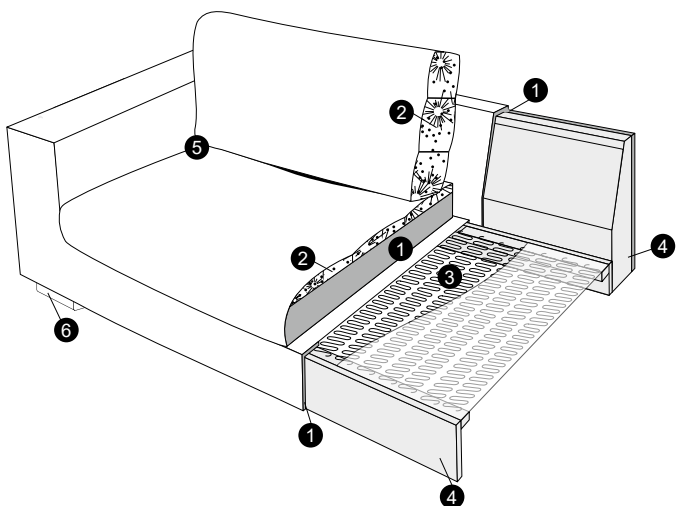

### lux

1. polyurethane foam / high resilient polyurethane foam
2. cushion chamber with mix of feather and silicone balls
3. springs
4. solid wood and wood based elements
5. fabric
6. solid wood legs