

# Sally

# SITS



# Sally

UPHOLSTERY

COMFORTS

COVERS

SPECIAL



fabric



standard



classic



loose



loose with velcro



modular system

Drawing show combinations with armrest II. Combinantons with other armrest are properly longer or shorter in width.  
All elements in loose cover with velcro are with french stitching on the armrest.

## loose cover elements

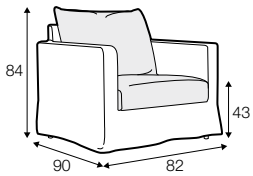

armchair

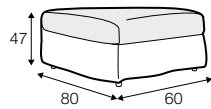

footstool 80x60

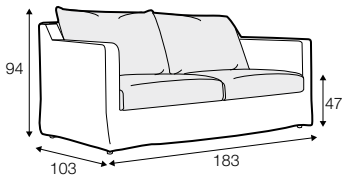

2 seater

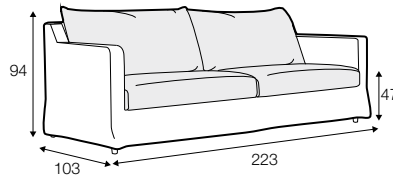

3 seater

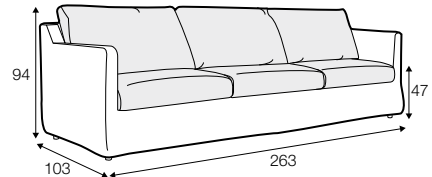

3XL seater divided

## loose cover elements with velcro

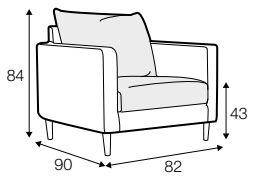

armchair

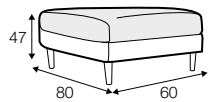

footstool 80x60

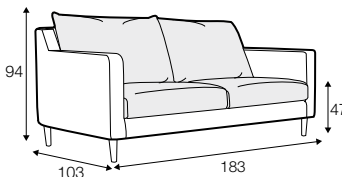

2 seater

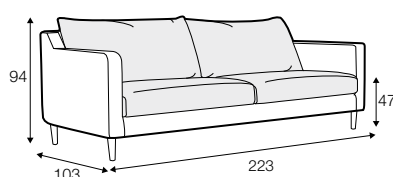

3 seater

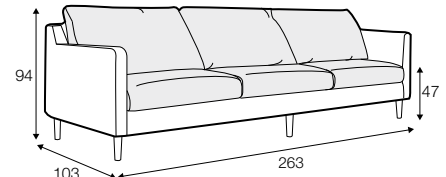

3XL seater divided

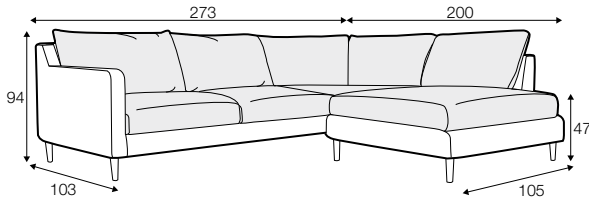

set 1 right  
2 seater left / or right + divan right / or left

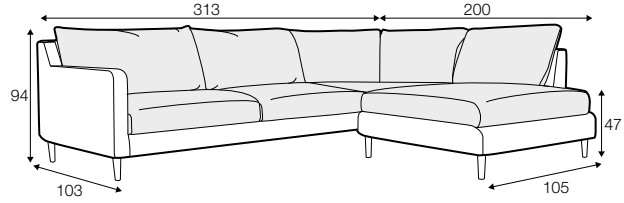

set 2 right  
3 seater left / or right + divan right / or left

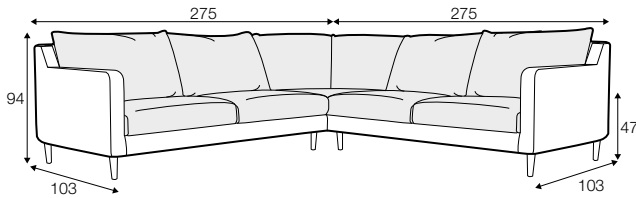

set 3  
2 seater left / or right + corner 90° + 2 seater right / or left

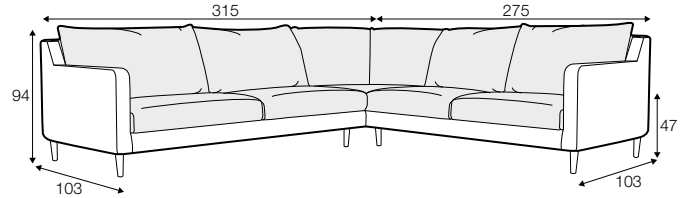

set 4 right  
2 seater right/ or left + corner 90 + 3 seater left/or right

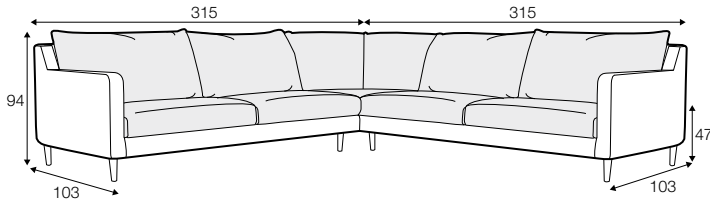

set 5  
3 seater left / or right + corner 90° + 3 seater right / or left

**modular system**

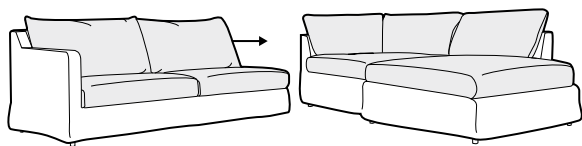

**elements of the modular system loose cover elements**

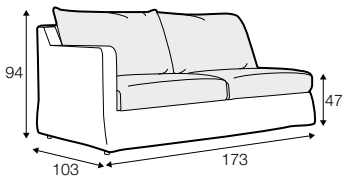

2 seater left / or right

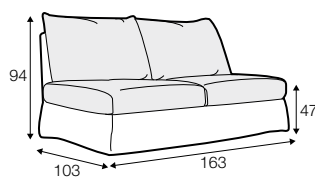

2 seater without armrests

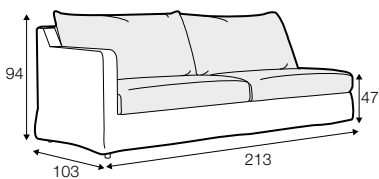

3 seater left / or right

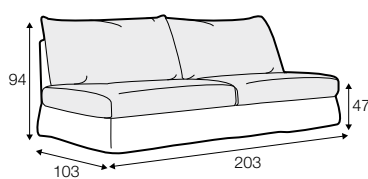

3 seater without armrests

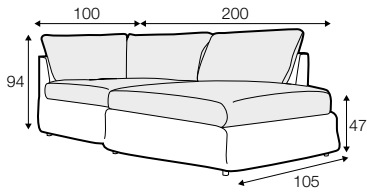

divan right / or left

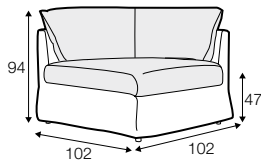

corner 90°

**loose cover elements with velcro**

---

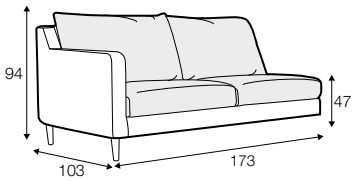

2 seater left / or right

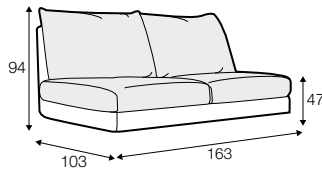

2 seater without armrests

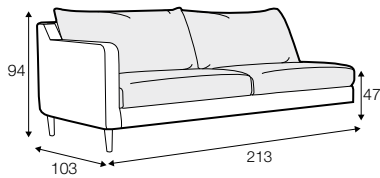

3 seater left / or right

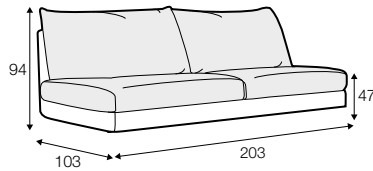

3 seater without armrests

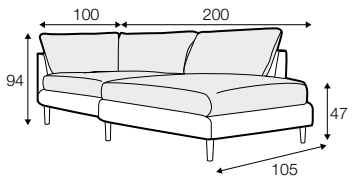

divan right / or left

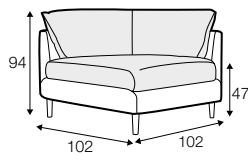

corner 90°

**extra dimensions**

---

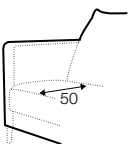

depth of armchair seat

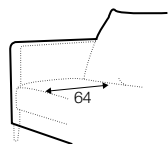

depth of sofa seat

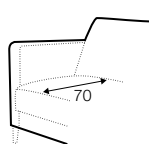

depth of armchair seat without cushions

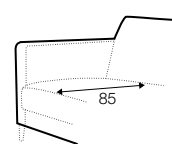

depth of sofa seat without cushions

## accessories

---

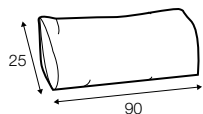

lumbar cushion 90x25  
cushion: 3 seater

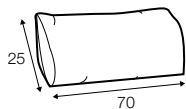

lumbar cushion 70x25  
cushion: 2 seater, 3XL seater

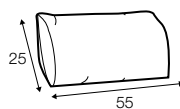

lumbar cushion 55x25  
cushion: divan, corner 90°

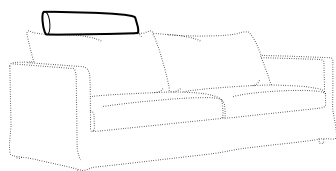

headrest L-90

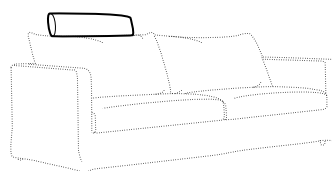
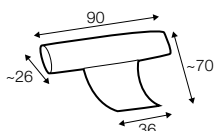

headrest L-80

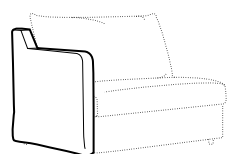
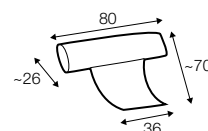

armrest I

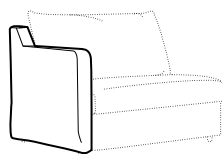
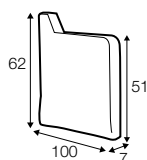

armrest II

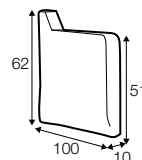

## legs

---

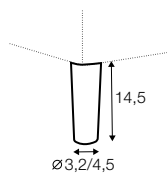

no. 153  
wood

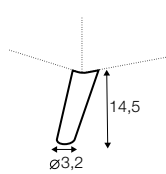

no. 141A  
wood  
back: only for armchair  
with front leg no. 153

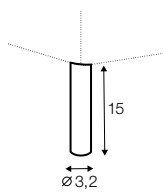

no. 195  
metal chrome,  
painted black

## profile

---

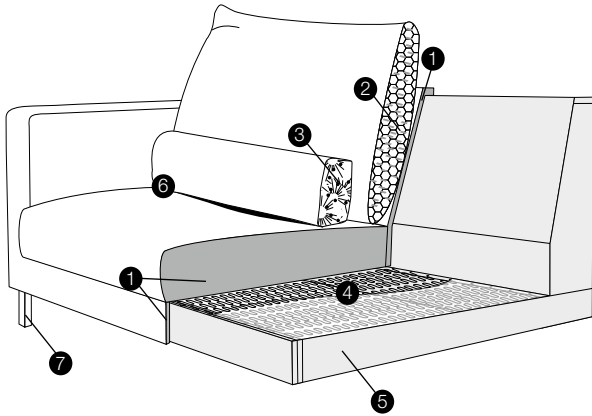

### standard

1. polyurethane foam/ high resilient polyurethane foam
2. cushion chamber with mix of foam flakes and silicone balls
3. cushion chamber with mix of feather and silicone balls
4. springs
5. solid wood and wood based elements
6. fabric
7. solid wood or metal legs

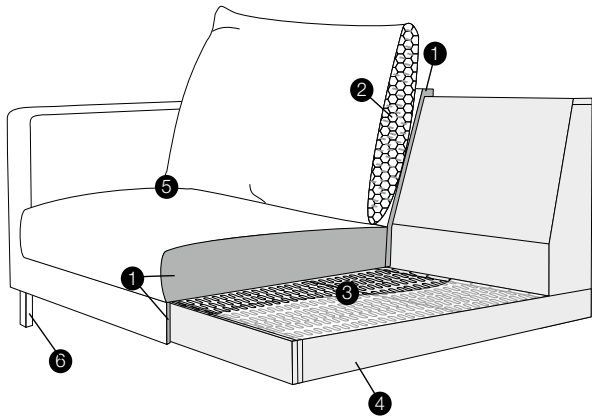

### classic

1. polyurethane foam/high resilient polyurethane foam
2. cushion chamber with mix of foam flakes and silicone balls
3. springs
4. solid wood and wood based elements
5. fabric
6. solid wood or metal legs