

# Polly

# SITS



# Polly

## UPHOLSTERY



fabric

## COMFORTS



standard



lux



classic

## COVERS



fixed



loose  
with velcro

## SPECIAL



modular  
system

Drawings shown height with leg no. 141A H-14.

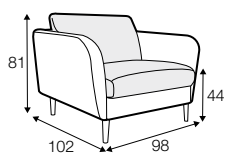

armchair

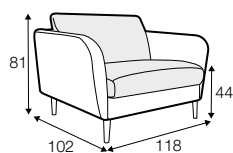

armchair wide

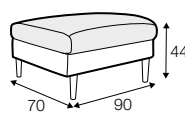

footstool 90x70

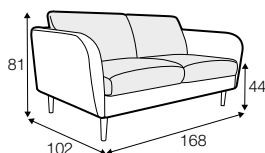

2 seater

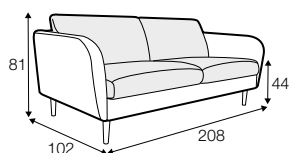

3 seater

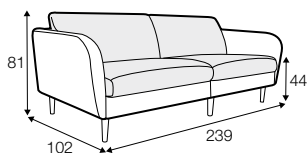

3XL seater (divided, two cushions)

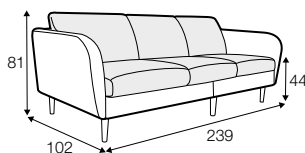

3XL seater (divided, three cushions)

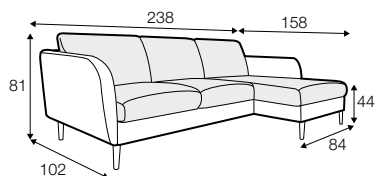

set 1 right / or left

2 seater left / or right  
+ chaiselongue right / or left

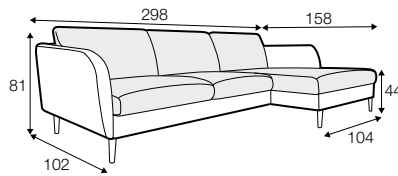

set 2 right / or left

3 seater left / or right  
+ chaiselongue wide right / or left

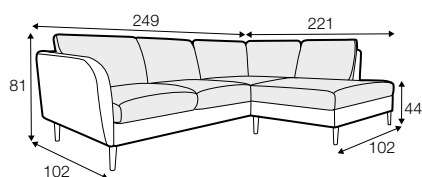

set 3 right / or left

2 seater left / or right + divan right / or left

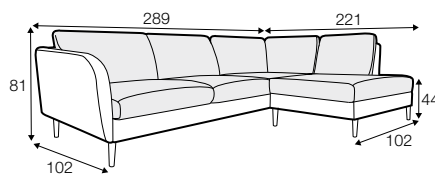

set 4 right / or left

3 seater left / or right + divan right / or left

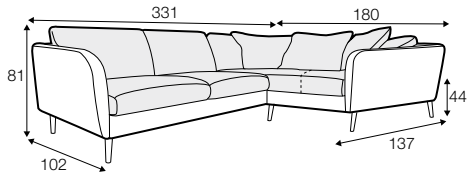

**set 5 right / or left**  
3 seater left / or right + cozy corner right / or left

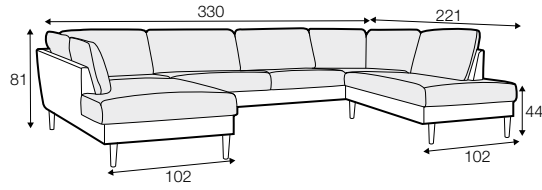

**set 6**  
divan left + 2 seater without armrests + divan right

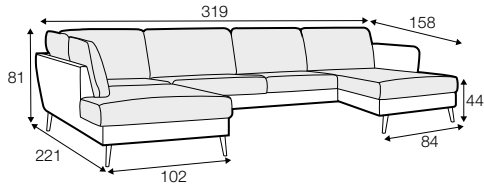

**set 7 left / or right**  
divan left / or right + 2 seater without armrests  
+ chaiselongue right / or left

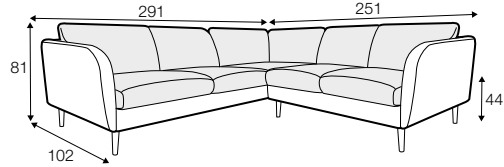

**set 8 right / or left**  
3 seater left / or right + corner 90° no. 1  
+ 2 seater right / or left

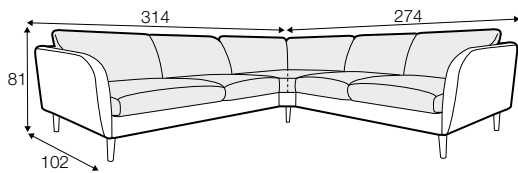

**set 9 right / or left**  
3 seater left / or right + corner 90° no. 2  
+ 2 seater right / or left

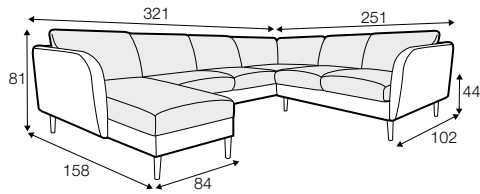

**set 10 left / or right**  
chaiselongue left / or right + 2 seater without armrests  
+ corner 90° no. 1 + 2 seater right / or left

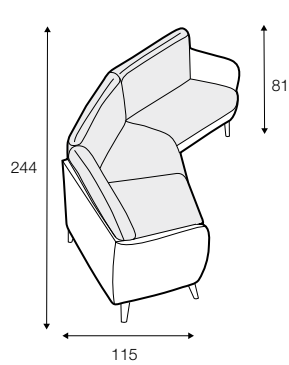

**set 13**  
armchair left + corner 30°  
+ armchair right

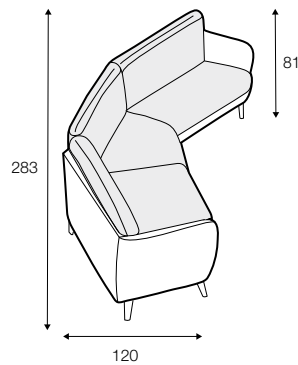

**set 14**  
armchair wide left + corner 30°  
+ armchair wide right

## modular system

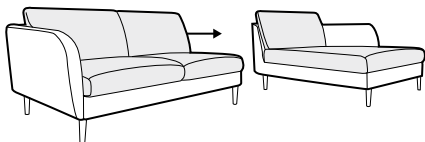

## elements of the modular system

---

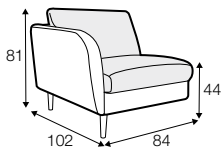

armchair left / or right

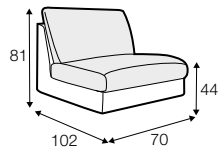

armchair without armrests

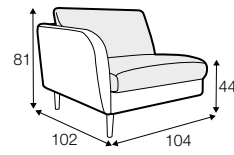

armchair wide left / or right

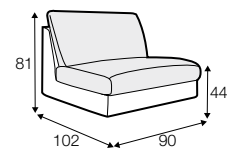

armchair wide without armrests

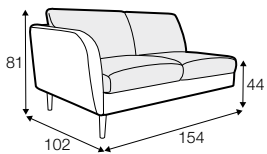

2 seater left / or right

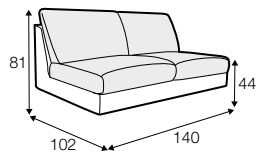

2 seater without armrests

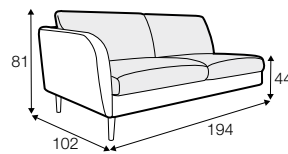

3 seater left / or right

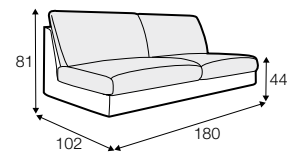

3 seater without armrests

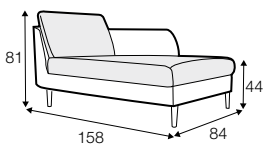

chaiselongue right / or left

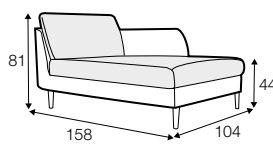

chaiselongue wide right / or left

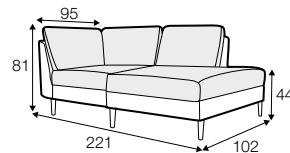

divan right / or left

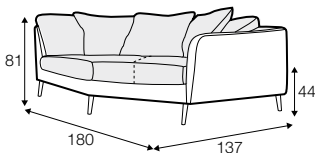

cozy corner right / or left

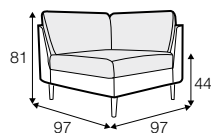

corner 90° no. 1

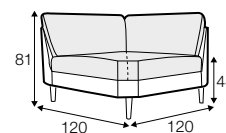

corner 90° no. 2

## accessories

---

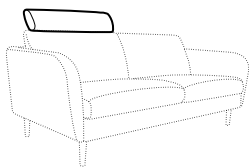

neckrest L-77

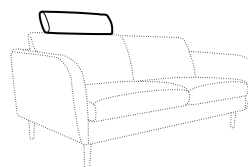
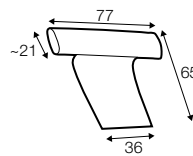

neckrest L-62

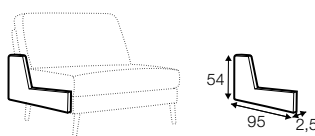
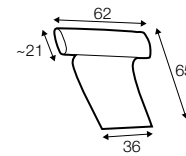

endpart left / or right

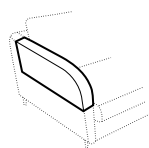

armrest protection

## extra dimensions

---

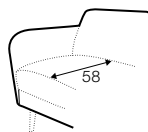

depth of seat

## legs

---

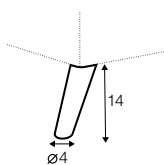

no. 141A  
wood  
recommended

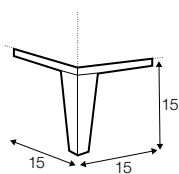

no. 152  
wood

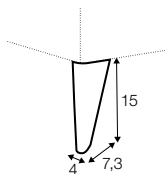

no. 91  
wood

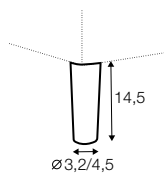

no. 153  
wood

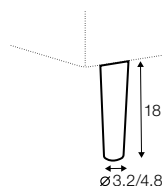

no. 141B  
wood

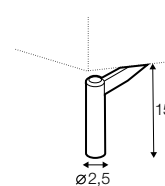

no. 145A  
metal chrome,  
painted black

## profile

---

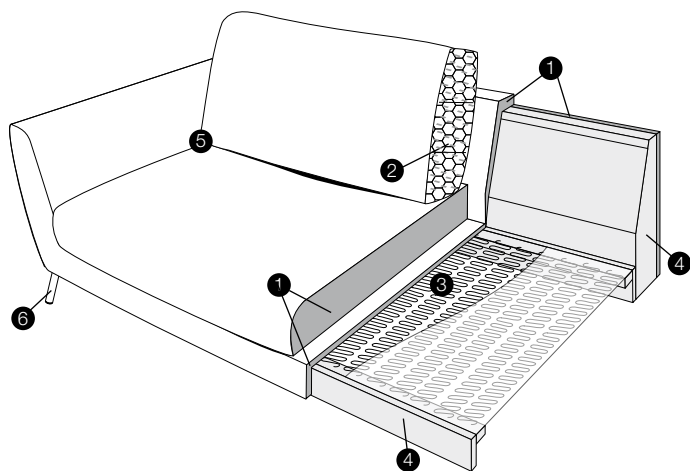

### classic

1. polyurethane foam/ high resilient polyurethane foam
2. foam flakes with silicone balls
3. springs
4. solid wood and wood based elements
5. fabric
6. solid wood or metal legs

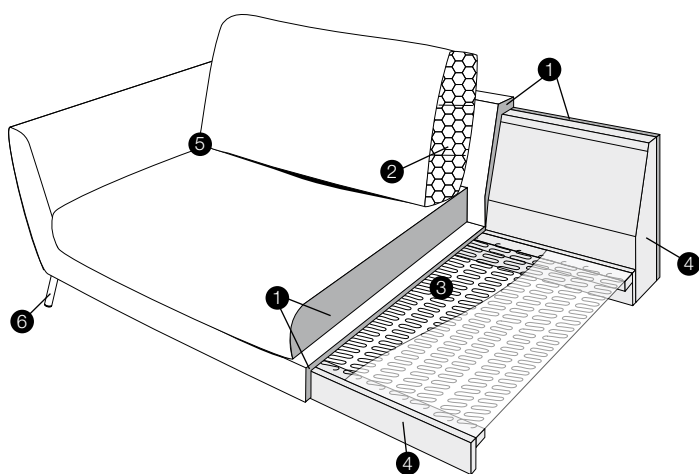

### standard

1. polyurethane foam/ high resilient polyurethane foam
2. silicone balls
3. springs
4. solid wood and wood based elements
5. fabric
6. solid wood or metal legs

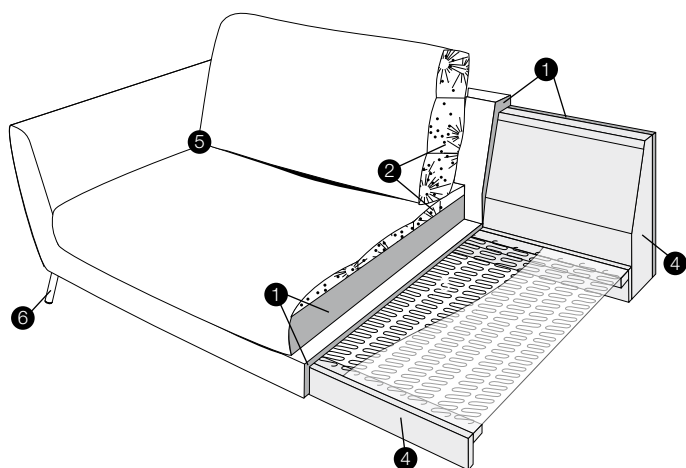

### lux

1. polyurethane foam/ high resilient polyurethane foam
2. cushion chamber with mix of feather and silicone balls
3. springs
4. solid wood and wood based elements
5. fabric
6. solid wood or metal legs