

# Milou

# SITS



# Milou

*M. Jüttner* *N. Kayser*

designed by: Böttcher & Kayser



UPHOLSTERY



fabric

COMFORTS



standard

COVERS



fixed

SPECIAL



modular system

All elements are freestanding.

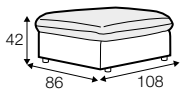

footstool 108x86

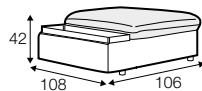

footstool 108x106  
with tray 103x19x9

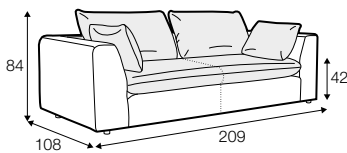

3 seater

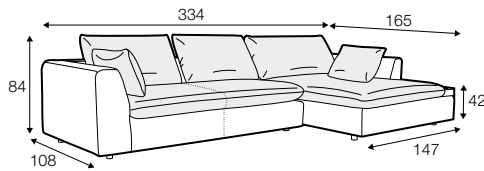

set 1 right / or left

3 seater left / or right + chaiselongue right / or left with tray 55x19x6

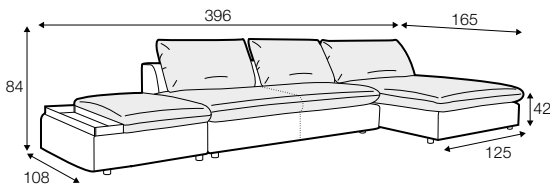

set 2 right / or left

footstool 108x106 with tray 103x19x9 + 3 seater without armrests  
+ chaiselongue without armrests

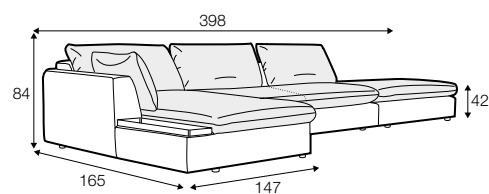

set 3 right / or left

chaiselongue left / or right with tray 55x19x6  
+ 3 seater without armrests + footstool 108x86

## modular system

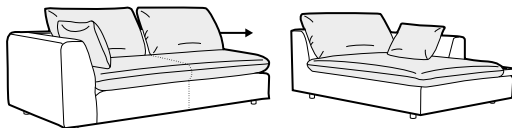

## elements of modular system

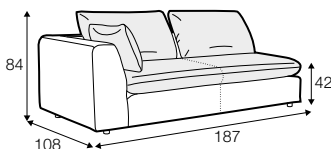

3 seater left / or right

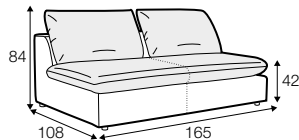

3 seater without armrests

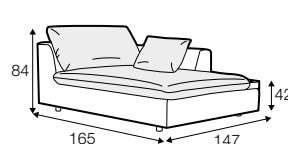

chaiselongue right / or left with tray 55x19x6



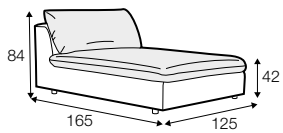

chaiselongue  
without armrests

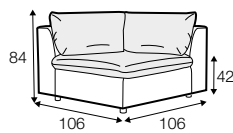

cornre 90°

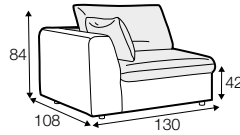

element 130x108  
left / or right

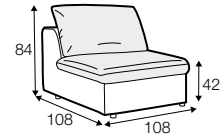

element 108x108

## extra dimensions

---

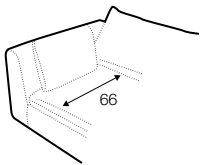

## accessories

---

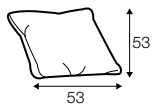

cushion 53x53

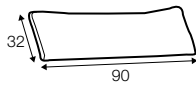

cushion 90x32

## legs

---

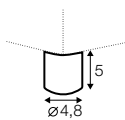

no. 173  
wood

## available materials for tray

---



veneer: oak



veneer: white



veneer: black

## profile

---

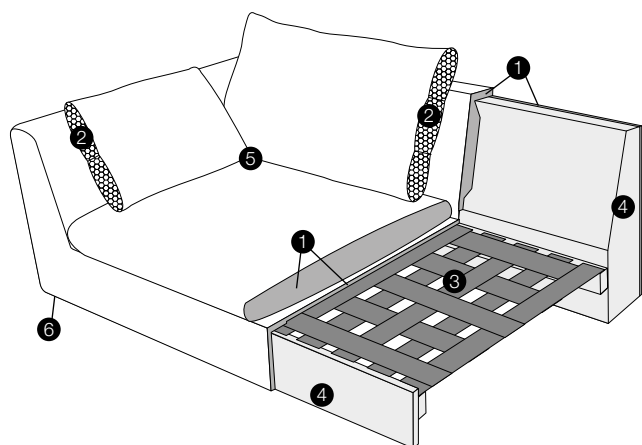

### standard

- 1. polyurethane foam / high resilient
- 2. silicone balls
- 3. upholstery belts
- 4. solid wood and wood based elements
- 5. fabric
- 6. solid wood legs