

Lill

SITS





Anna Näsström

designed by: Anna Näsström



UPHOLSTERY COMFORTS

COVERS



fabric



standard



lux



loose



loose with velcro

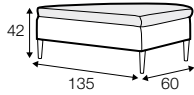

footstool 135x60
loose cover with velcro

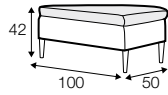

footstool 100x50
loose cover with velcro

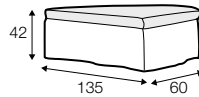

footstool 135x60
loose cover

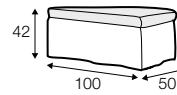

footstool 100x50
loose cover

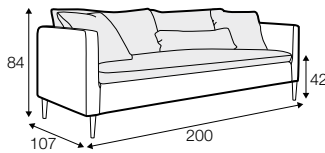

2 seater
loose cover with velcro

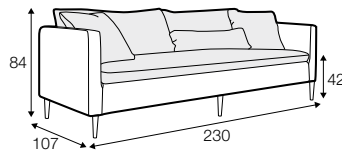

3 seater divided
loose cover with velcro

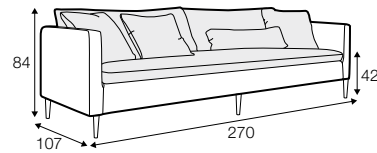

4 seater divided
loose cover with velcro

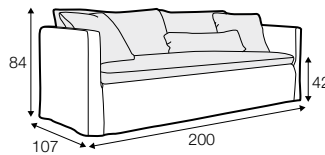

2 seater
loose cover

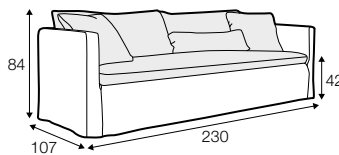

3 seater divided
loose cover

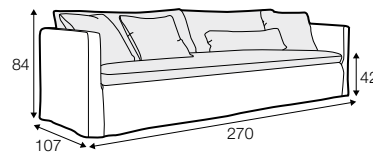

4 seater divided
loose cover

accessories

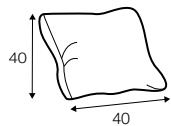

cushion
40x40

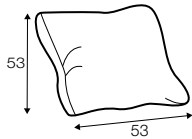

cushion
53x53

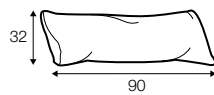

cushion
90x32

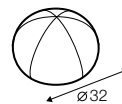

pillow round
only standard comfort

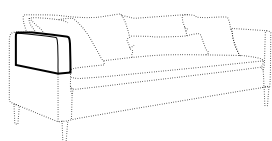

armrest protection

extra dimensions

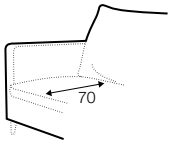

depth of seat

legs

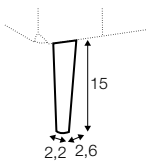

no. 138
wood

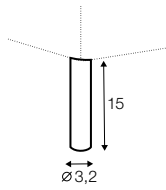

no. 195
metal chrome,
painted black

profile

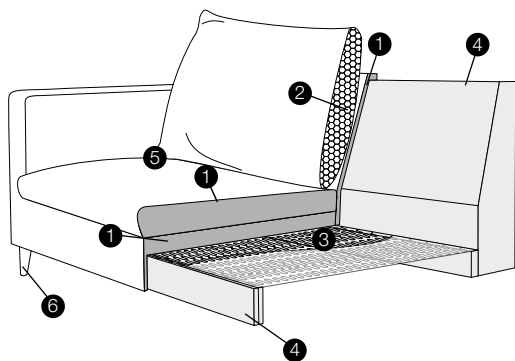

standard

1. polyurethane foam/high resilient polyurethane foam
2. silicone balls
3. springs
4. solid wood and wood based elements
5. fabric
6. solid wood or metal legs

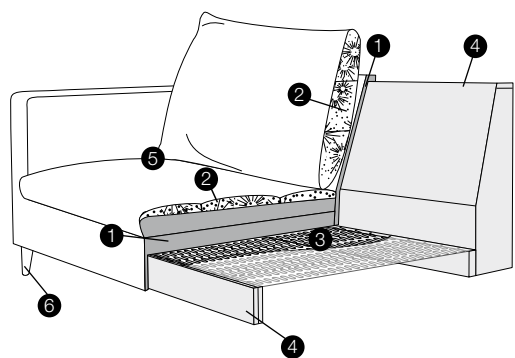

lux

1. polyurethane foam/high resilient polyurethane foam
2. cushion chamber with mix of feather and silicone balls
3. springs
4. solid wood and wood based elements
5. fabric
6. solid wood legs