

Jenny

SITS



Jenny

J. Archer

designed by: Ian Archer



UPHOLSTERY COMFORTS COVERS SPECIAL



fabric



STD standard



FC fixed



modular system

All drawings shown height with leg no. 159.

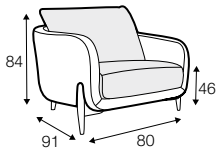

armchair

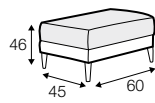

footstool 60x45

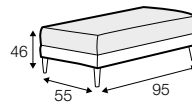

footstool 95x55

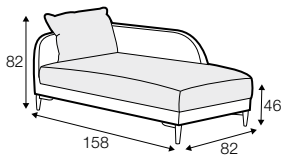

chaiselongue
freestanding left

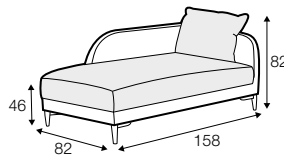

chaiselongue
freestanding right

version A

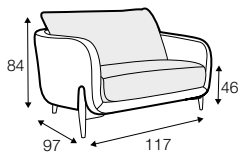

armchair wide

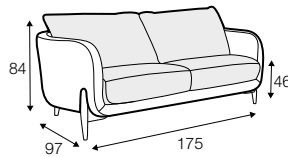

2 seater

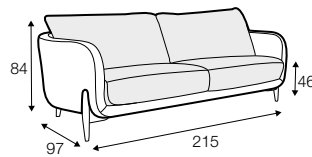

3 seater

version C

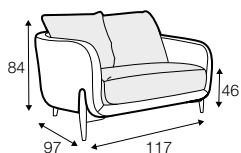

armchair wide

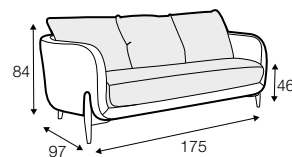

2 seater

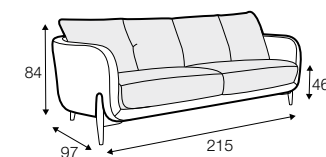

3 seater

example of sets with back cushions combinations

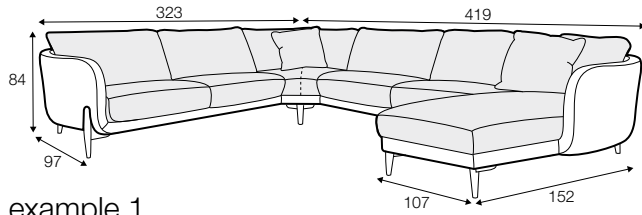

example 1

3 seater ver. A left / or right
 + corner 90° round ver. C
 + 3 seater without armrests ver. A
 + chaiselongue wide ver. C right / or left

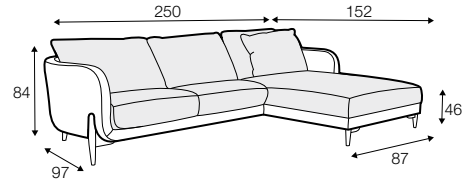

example 2

2 seater ver. A left / or right
 + chaiselongue ver. C right / or left

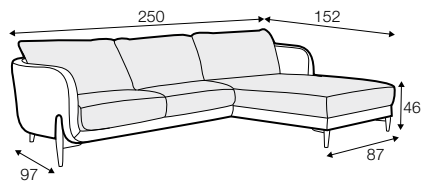

set 1 ver. A right (or left)

2 seater ver. A left / or right
 + chaiselongue ver. A right / or left

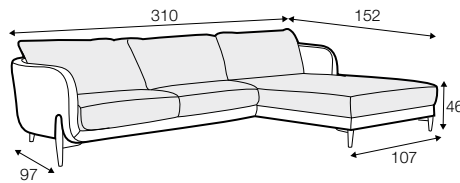

set 2 ver. A right (or left)

3 seater ver. A left / or right
 + chaiselongue wide ver. A right / or left

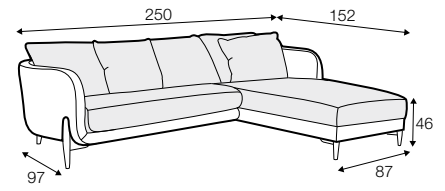

set 1 ver. C right (or left)

2 seater ver. C left / or right
 + chaiselongue ver. C right / or left

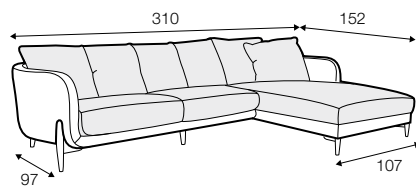

set 2 ver. C right (or left)

3 seater ver. C left / or right
 + chaiselongue wide ver. C right / or left

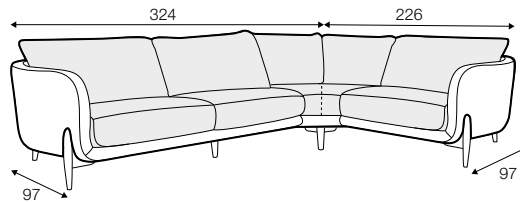

set 5 ver. A right (or left)

3 seater ver. A left / or right
 + corner 90 round ver. A
 + armchair wide ver. A right / or left

modular system

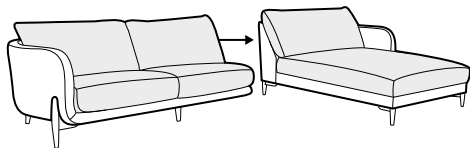

elements of the modular system version A

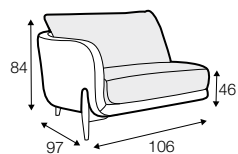

armchair wide
 left / or right

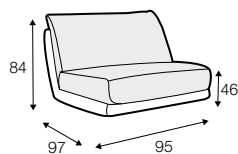

armchair wide
 without armrests

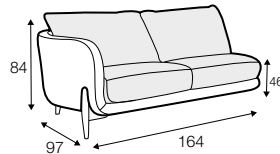

2 seater left / or right

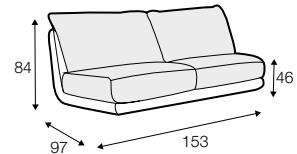

2 seater
 without armrests

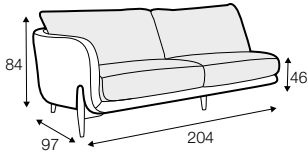

3 seater left / or right

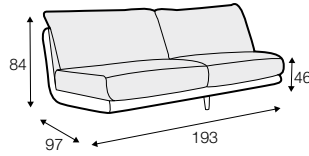

3 seater without armrests

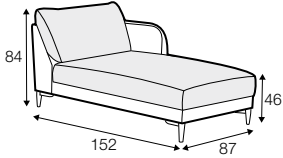

chaiselongue right / or left

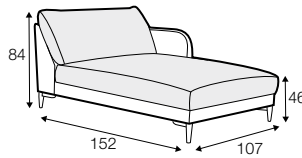

chaiselongue wide right / or left

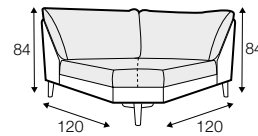

corner 90° round

elements of the modular system version C

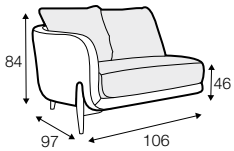

armchair wide
left / or right

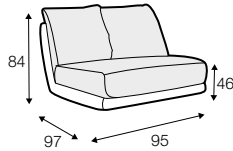

armchair wide
without armrests

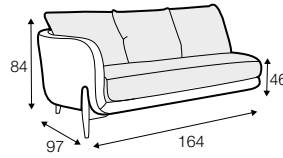

2 seater left / or right

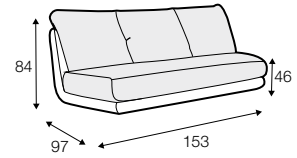

2 seater
without armrests

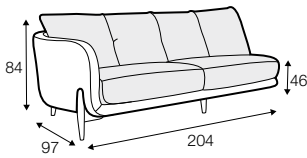

3 seater left / or right

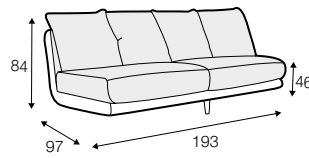

3 seater without armrests

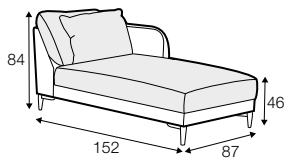

chaiselongue
right / or left

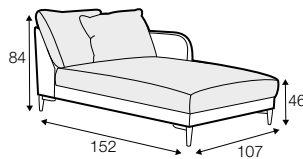

chaiselongue wide
right / or left

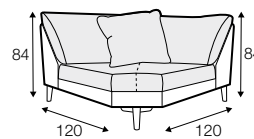

corner 90° round

extra dimensions

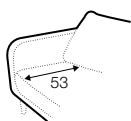

depth of
armchair seat

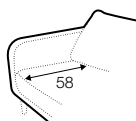

depth of
sofa seat

accessories

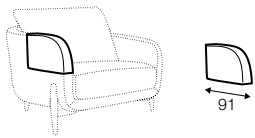

armrest protection
armchair

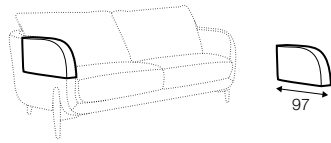

armrest protection
armchair wide, 2 seater, 3 seater

legs

The width of the sofas depends on the legs. The difference is 5 cm overall dimensions.

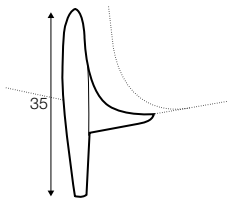

no. 159
wood
front

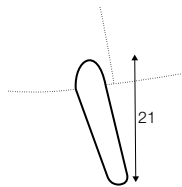

no. 159A
wood
back

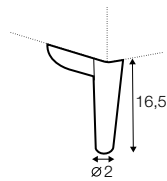

no. 159B
wood
only chaiselongue

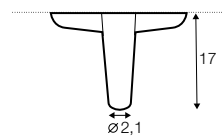

no. 159C
wood
only corner

profile

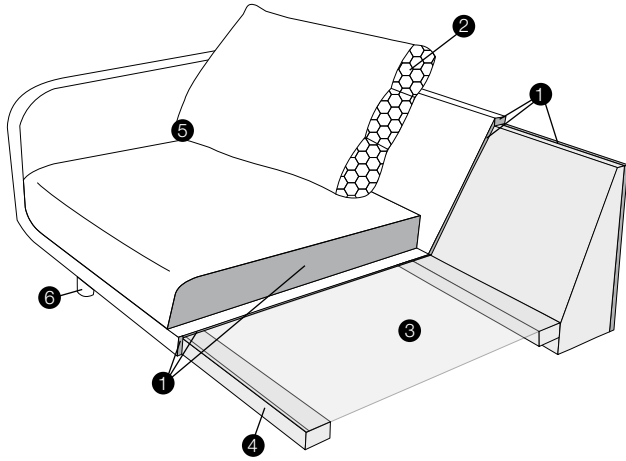

standard

1. polyurethane foam/high resilient polyurethane foam
2. silicone balls
3. dynaflex - elastic fabric
4. solid wood and wood based elements
5. fabric
6. solid wood legs