

Hugo

SITS



Hugo

J. Archer

designed by: Ian Archer



UPHOLSTERY

COMFORTS

COVERS



fabric



leather



STD standard



CLS classic



LUX lux



FC fixed

All drawings shown height with leg no. 145A H-20.

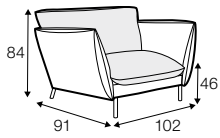

armchair

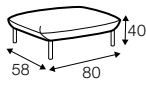

footstool 80x58

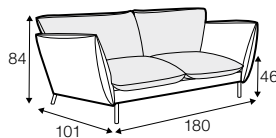

2 seater

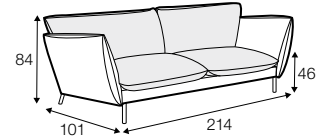

3 seater

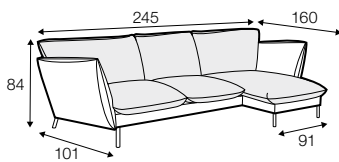

set 1 right / or left

2 seater left / or right

+ chaiselongue right / or left

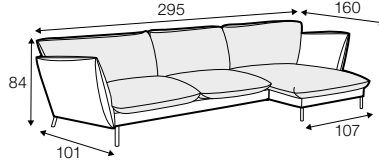

set 2 right / or left

3 seater left / or right

+ chaiselongue wide right / or left

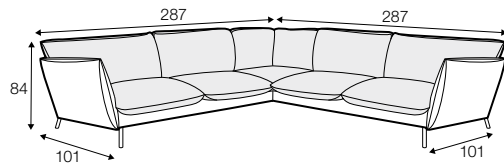

set 3

3 seater left + corner 90° + 3 seater right

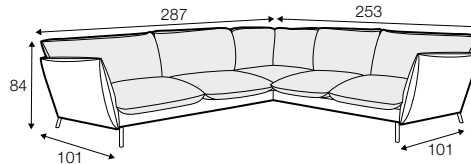

set 4 right / or left

3 seater left / or right + corner 90° + 2 seater right / or left

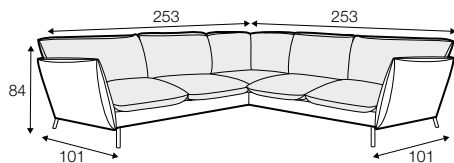

set 5

2 seater left + corner 90° + 2 seater right

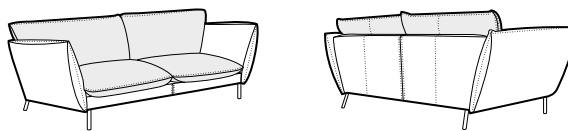

example of leather cover

3 seater

extra dimensions



depth of seat

accessories

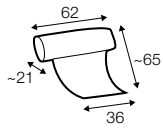
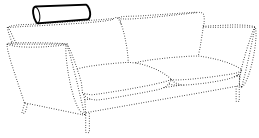

headrest L-62

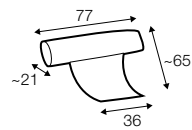
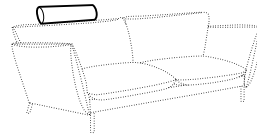

headrest L-77

legs

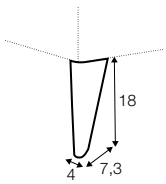

no. 91
wood
front

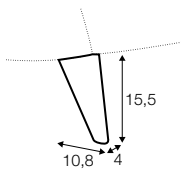

no. 91
wood
back

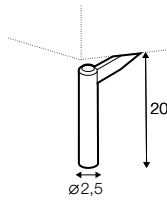

no. 145A
metal chrome,
painted black
front

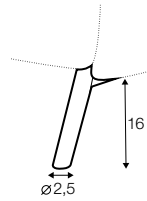

no. 157
metal chrome,
painted black
back

profile

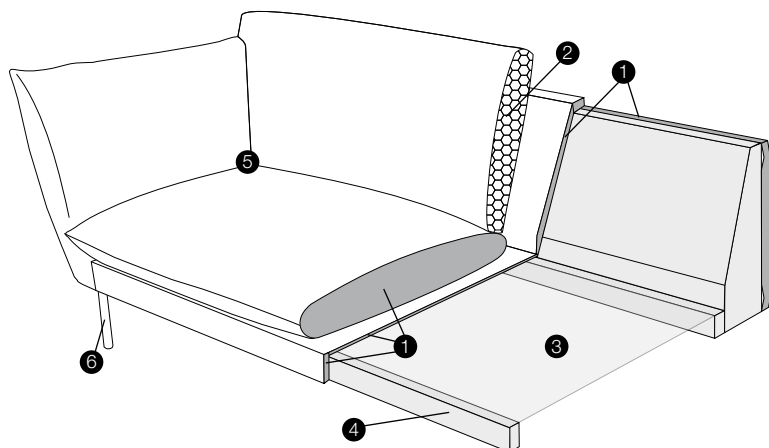

standard

1. polyurethane foam/high resilient polyurethane foam
2. silicone balls
3. dynaflex - elastic fabric
4. solid wood and wood based elements
5. fabric or leather
6. painted metal, chrom or brushed legs

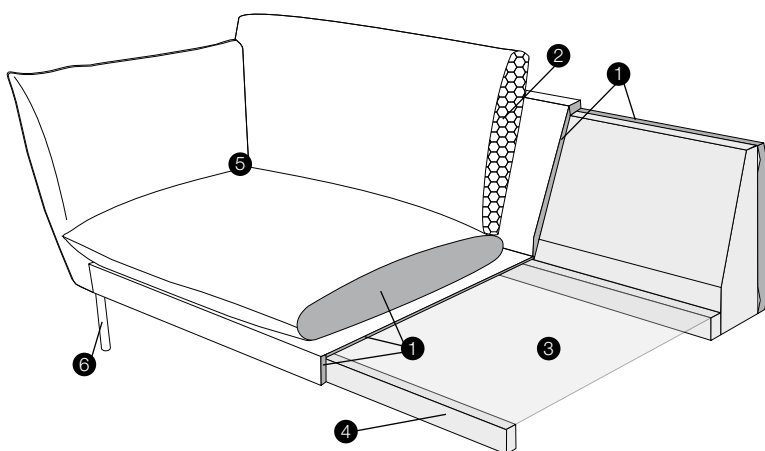

classic

1. polyurethane foam/high resilient polyurethane foam
2. silicone balls
3. dynaflex - elastic fabric
4. solid wood and wood based elements
5. fabric or leather
6. painted metal, chrom or brushed legs

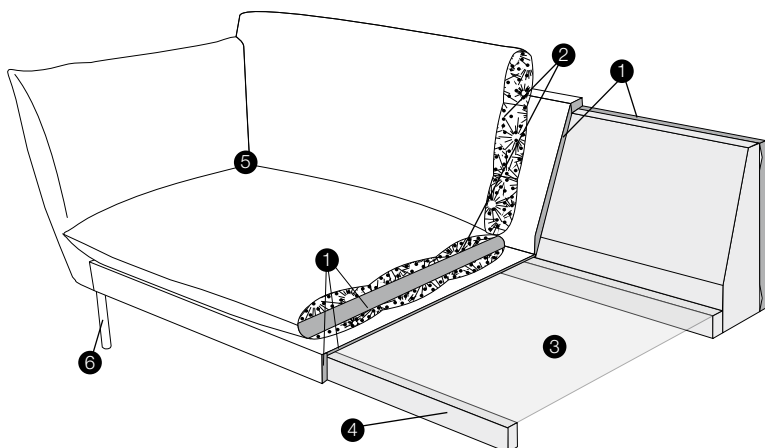

lux

1. polyurethane foam/high resilient polyurethane foam
2. cushion chamber with mix of feather and silicone balls
3. dynaflex - elastic fabric
4. solid wood and wood based elements
5. fabric or leather
6. painted metal, chrom or brushed legs