

Frej

SITS



Frej

Mr. Jötter *W. Kayser*

designed by: Böttcher & Kayser



UPHOLSTERY



fabric



leather

COMFORTS



STD standard

COVERS



FC fixed

SPECIAL



modular system

All elements available in combination fabric and leather.

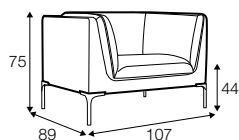

armchair

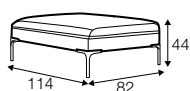

footstool 114x82

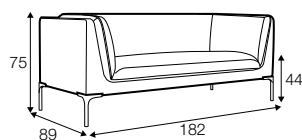

2 seater

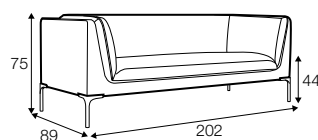

3 seater

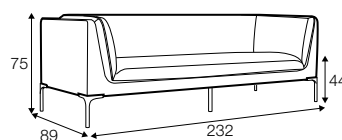

3,5 seater

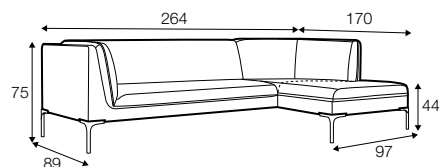

set 1 right / or left

3 seater left / or right + chaiselongue right / or left

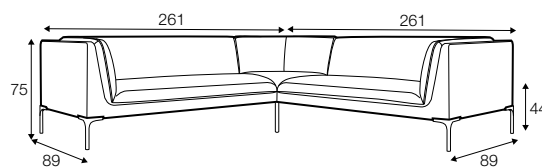

set 2 right / or left

3 seater left / or right + corner 90° + 3 seater right / or left

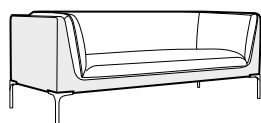

example

mix fabric and leather

modular system

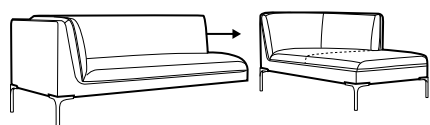

elements of the modular system

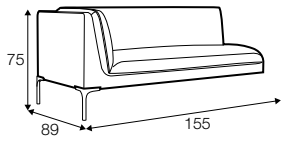

2 seater left / or right

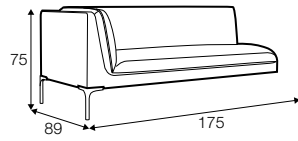

3 seater left / or right

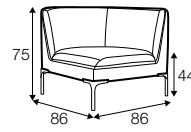

corner 90°

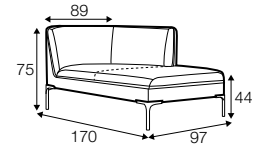

chaiselongue right / or left

extra dimensions

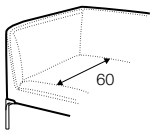

depth of seat

accessories

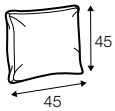

cushion
45x45

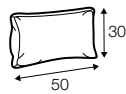

cushion
50x30

legs

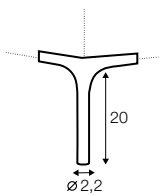

no. 198
metal chrome,
painted black or
brass gold

profile

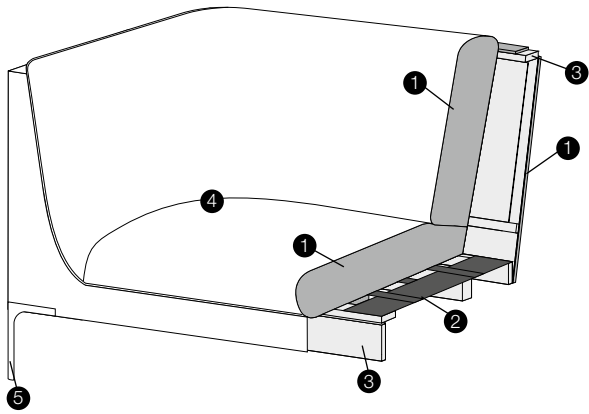

standard

- 1. polyurethane foam / high resilient polyurethane foam
- 2. upholstery belts
- 3. solid wood and wood based elements
- 4. fabric or leather
- 5. metal legs