

Brandon

SITS



Brandon

UPHOLSTERY



fabric



** leather only in FC

COMFOTS



STD standard



LUX lux

COVERS



FC fixed



LC loose

SPECIAL



modular system

All drawings shown height with leg no. 84 H-10.

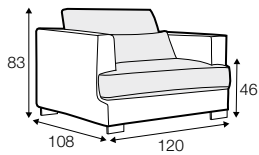

armchair

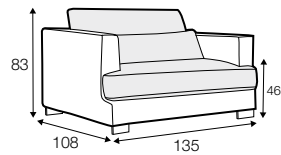

armchair wide

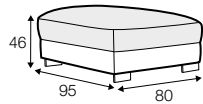

footstool 95x80

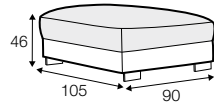

footstool 105x90

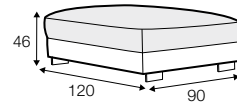

footstool 120x90

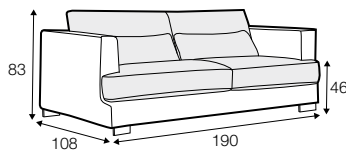

2 seater

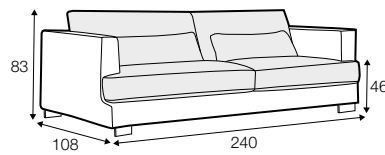

3 seater / or 3 seater divided

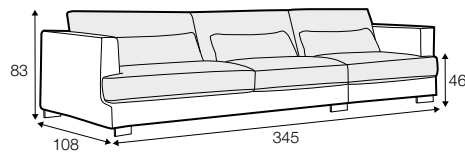

set 1

3 seater left + armchair wide right

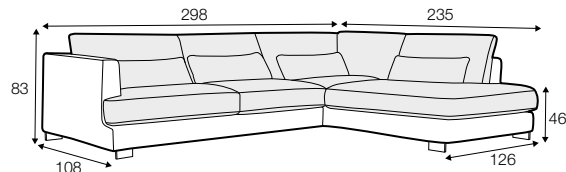

set 2 right / or left

2 seater left / or right + divan right / or left

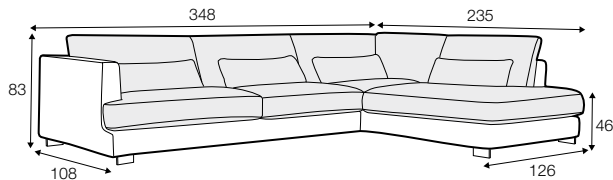

set 3 right / or left

3 seater left / or right + divan right / or left

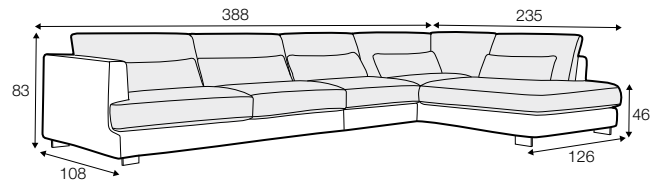

set 4 right / or left

2 seater left / or right + armchair without armrests + divan right / or left

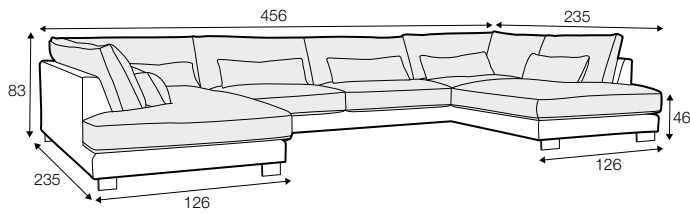

set 15
divan left + 3 seater without armrests + divan right

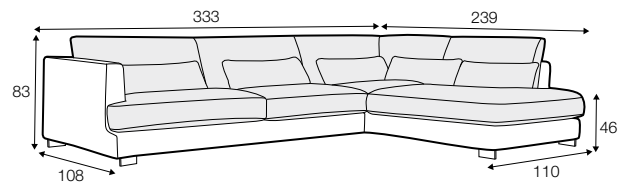

set 16 right / or left
3 seater left / or right + corner 90° + bench right / or left

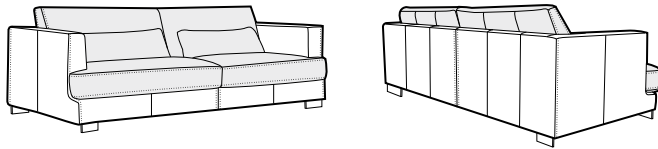

example of leather cover
3 seater

modular system

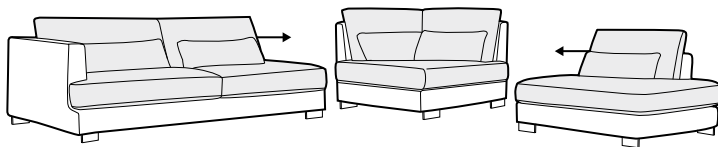

elements of the modular system

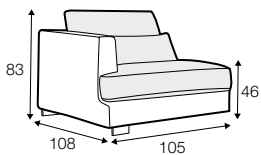

armchair left / or right

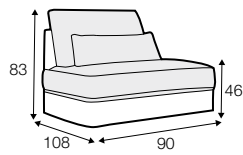

armchair
without armrests

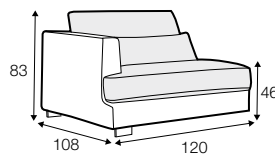

armchair wide left / or right

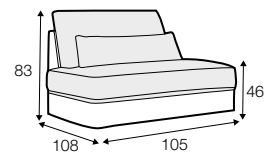

armchair wide
without armrests

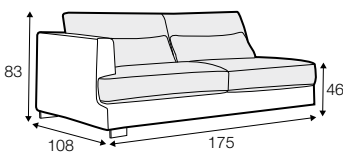

2 seater left / or right

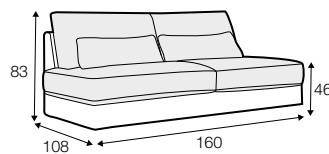

2 seater without armrests

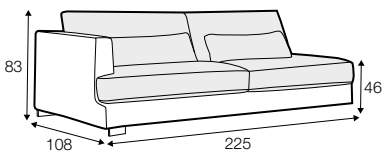

3 seater left / or right

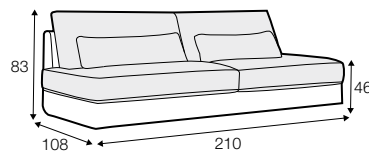

3 seater without armrests

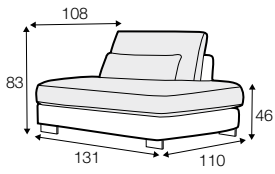

bench right / or left

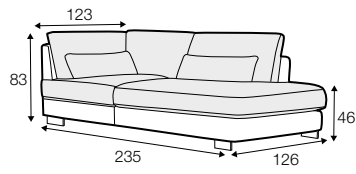

divan right / or left
or divan divided right / or left

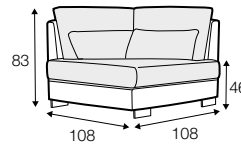

corner 90°

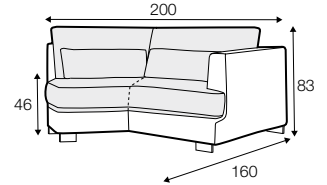

corner 35° right / or left

extra dimensions

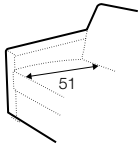

depth of seat

accessories

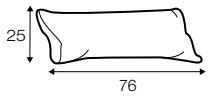

cushion
76x25

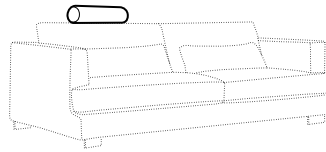

headrest with roll L-70

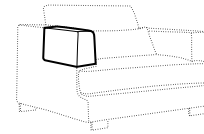
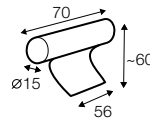

armrest protection



legs

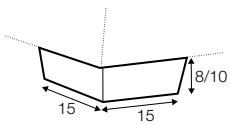

no. 07
wood

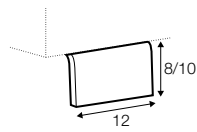

no. 84
metal chrome,
painted black

profile

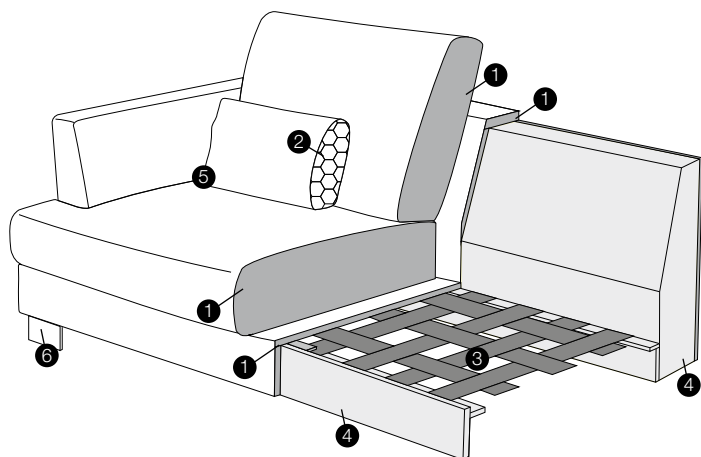

standard

1. polyurethane foam / high resilient polyurethane foam
2. silicone balls
3. upholstery belts
4. solid wood and wood based elements
5. fabric
6. solid wood/metal legs

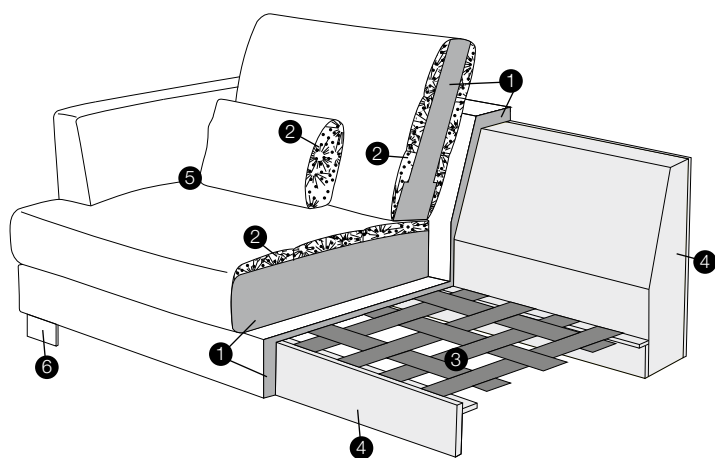

lux

1. polyurethane foam / high resilient polyurethane foam
2. cushion chamber with mix of feather and silicone balls
3. upholstery belts
4. solid wood and wood based elements
5. fabric and leather
6. solid wood or metal legs