

# Betty

SITS



# Betty

*auter*

designed by: Dan Ihreborn



## UPHOLSTERY



fabric

## COMFORTS



LUX lux



CLS classic

## COVERS



FC fixed



LCV loose with velcro

## SPECIAL



modular system

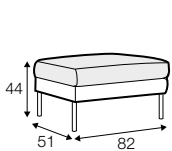

footstool 82x51

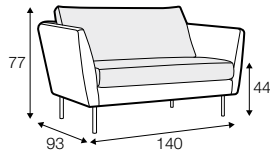

loveseat

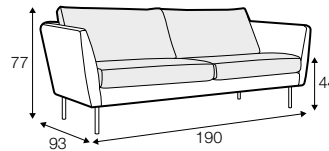

2 seater

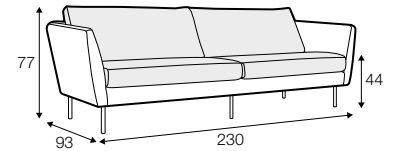

3 seater

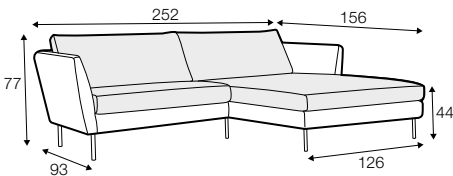

set 1 right / or left  
loveseat left / or right  
+ chaiselongue wide right / or left

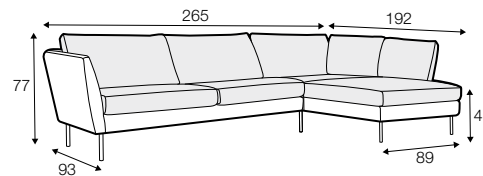

set 2 right / or left  
2 seater left / or right + divan right / or left

## modular system

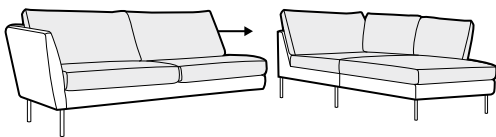

## elements of the modular system

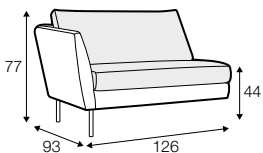

loveseat left / or right

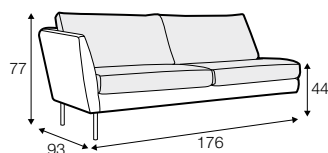

2 seater left / or right

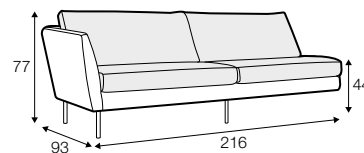

3 seater left / or right

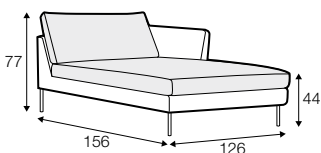

chaiselongue wide right / or left

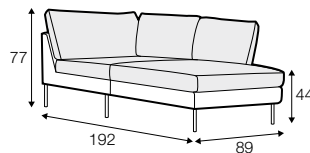

divan right / or left

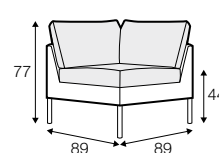

corner 90°

## extra dimensions

---

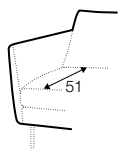

depth of seat

## accessories

---

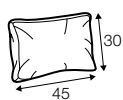

cushion  
45x30

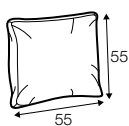

cushion  
55x55

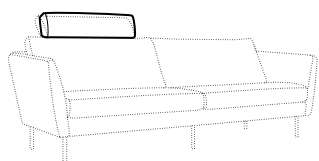

headrest L-65

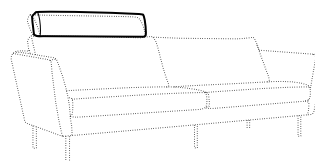
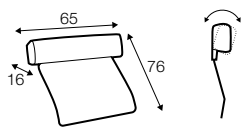

headrest L-85

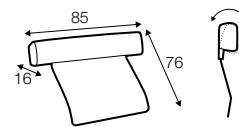

## legs

---

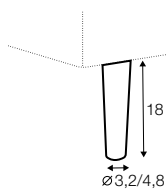

no. 141  
wood

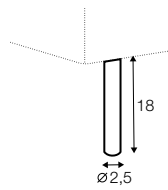

no. 177  
metal chrome,  
painted black

## profile

---

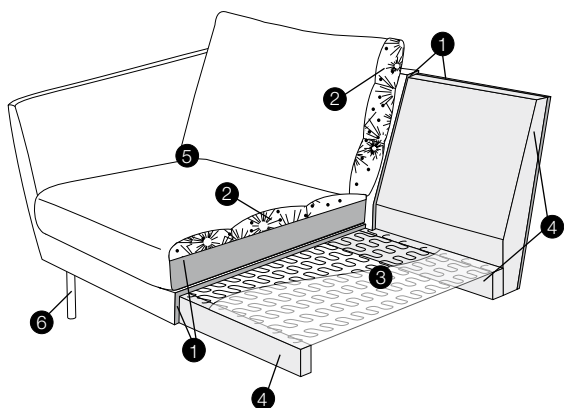

### lux

1. polyurethane foam/high resilient polyurethane foam
2. cushion chamber with mix of feather and silicone balls
3. springs
4. solid wood and wood based elements
5. fabric
6. solid wood or metal legs

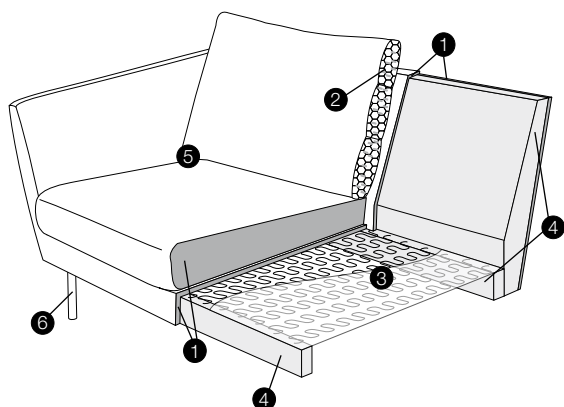

### classic

1. polyurethane foam/high resilient polyurethane foam
2. foam flakes with silicone balls
3. springs
4. solid wood and wood based elements
5. fabric
6. solid wood or metal legs