

**HEADBOARD ONLY**

**ASSEMBLY INSTRUCTION  
COASTER FINE FURNITURE**



**ASSEMBLY TIPS:**

1. Remove hardware from box and sort by size.
2. Please check to see that all hardware and parts are present prior to start of assembly.
3. Please follow attached instructions in the same sequence as numbered to assure fast & easy assembly.

**▲ Warning**

1. Don't attempt to repair or modify parts that are broken or defective. Please contact the store immediately.
2. This product is for home use only and not intended for commercial establishment.

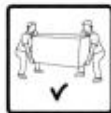

ASSEMBLY TIME PER UNIT: 20 MINUTES

**PARTS IDENTIFICATION**

**A**

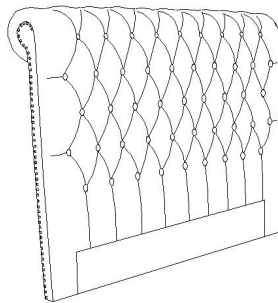



**HEADBOARD 1 PC**

**B**



**LEG 2 PCS**

**HARDWARE PACKAGE**

1	ALLEN WRENCH 5*23*73mm		1 PC
8	HEXAGON SOCKET SCREW 4cm		4 PCS
9	PLASTIC WASHER		4 PCS

ALL ABOVE HARDWARE PACK IS LOCATED IN 300652F B1

STEP 1

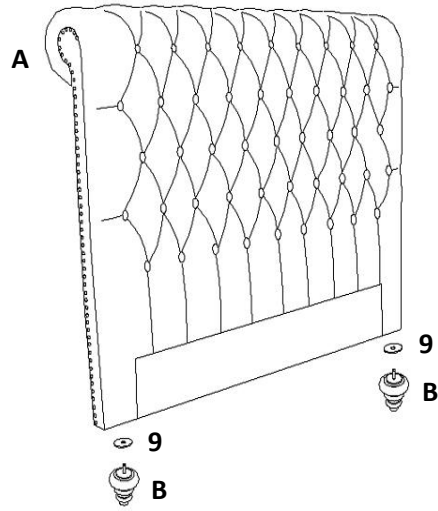

STEP 2

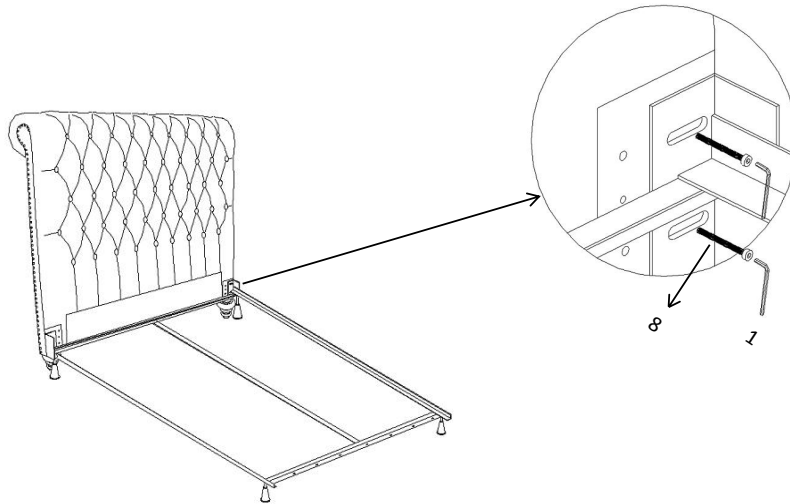

STEP 3

