

## Input Power Connections

### STEP 4

#### 110-240V AC

Connect the supplied 110-240 Volt AC plug to 110-240 power located on the machine where the Power Analyzer is being installed.

AC plug adapter (shown) may be required. Not included.

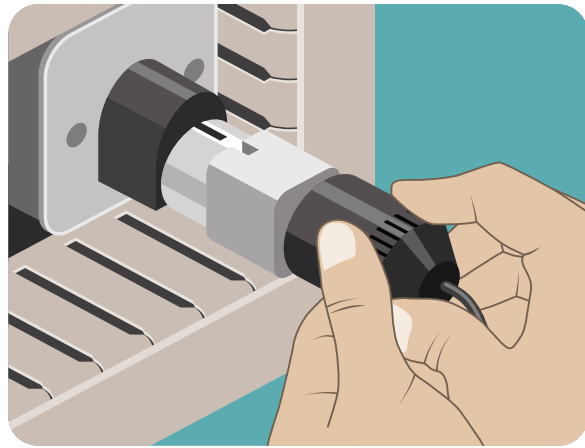

**NOTE:** The 3-core power cable will be connected to the 3-pin brass connector on the rear of the Power Analyzer Unit upon shipment.

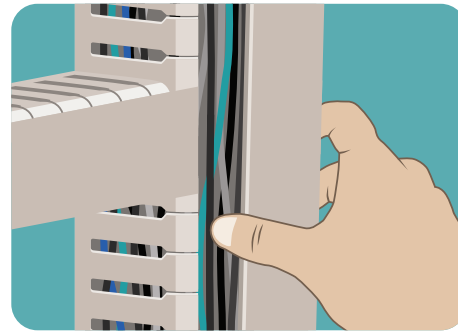
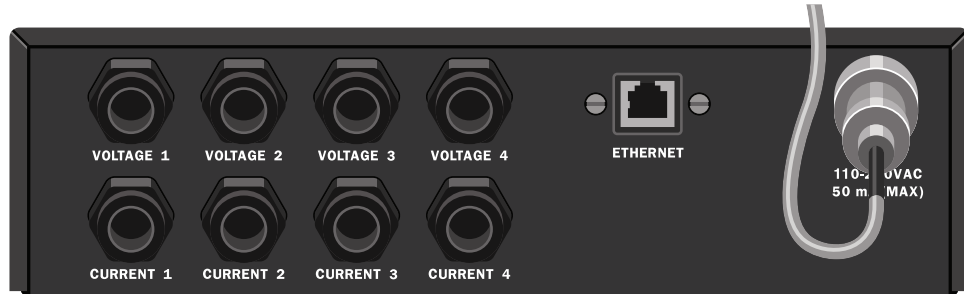
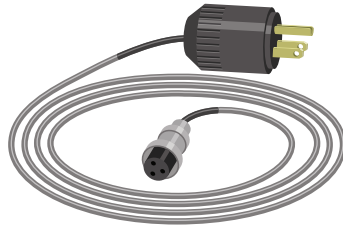

Neatly route any excess cable in available cable trays. Use wire ties and self-adhesive cable tie mounts to tidy your installation.

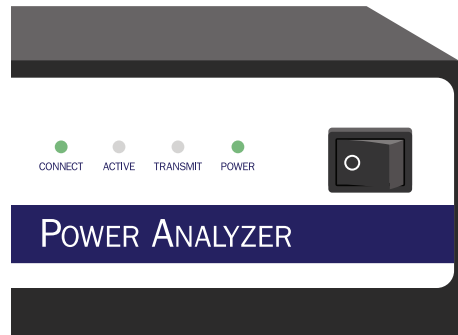

Make sure the 3-core power cable is properly connected to the rear of the Power Analyzer and the plug is connected to 110-240V AC power. Turn the rocker power switch to the 'ON' position. Immediately, the LEDs corresponding to 'Power' will light. After approximately 30 seconds, the 'Connect' and 'Active' lights will turn on. If not, check power connections from the back of the Power Analyzer box to the supplied power.

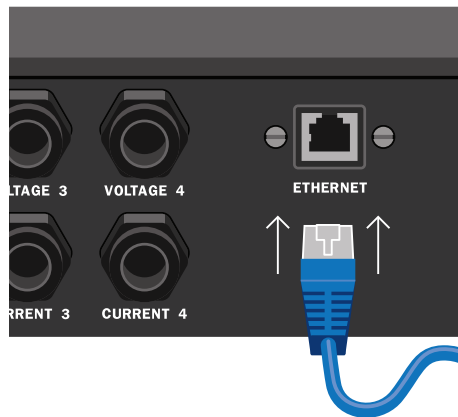

Connect a user supplied Ethernet cable to the rear of the Power Analyzer box connecting the other end to the user supplied network with internet access. For WiFi installations please refer to the *Wifigurator Network Connection Guide* for connection instructions.



Download the MachineSense Wifigurator App from the App Store or the Play Store.

# Multi-Port Power Analyzer Quick Start Guide



#### WARNING: Voltage hazard

Before making electrical connections always disconnect and lock out the main power sources to prevent injury from unexpected energization or start-up. Electrical connections should be made only by qualified personnel.



#### WARNING: Improper installation, operation, or servicing may result in equipment damage or personal injury

This equipment should be installed, adjusted, and serviced by qualified electrical technicians. All wiring and disconnects should be installed by a qualified electrical technician in accordance with electrical codes in your region.

Install the Power Analyzer box into the control cabinet of the machine/component to be monitored. The feet can be used to secure the Power Analyzer to the cabinet.



### Power Analyzer Overview

- 1 Connect LED
- 2 Active LED
- 3 Transmit LED
- 4 Power On LED
- 5 Power On/Off Switch
- 6 Voltage Probes
- 7 Current Probes
- 8 Ethernet Port
- 9 110-240V AC Input



221 E. Thomas Avenue Baltimore, MD 21225 +1-443-457-1165 www.machinesense.com

QC-INSTALL-PA-MULTI-001-0118

## Accessories Included

- 1 110V AC Power Cable
- 2 (3) Voltage Probes (Alligator Clips)
- 3 (3) Voltage Leads
- 4 (3) Voltage Connectors
- 5 (3) 300 Amp Current Sensors or
- 6 (3) 100 Amp Current Sensors

**NOTE:** Appearance will vary depending on the current sensor option ordered. You will receive (3) current sensors. Upon shipment, the power cable for the current sensors will be connected to the current probe connection located on the rear of the Power Analyzer.

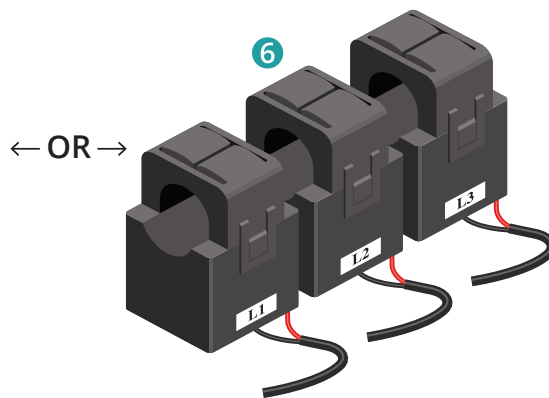
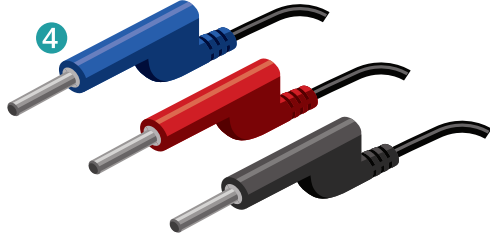
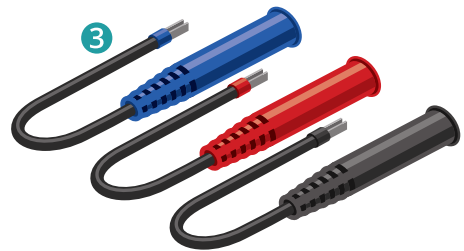
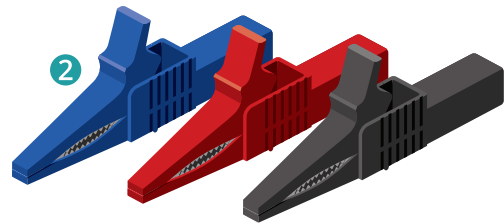
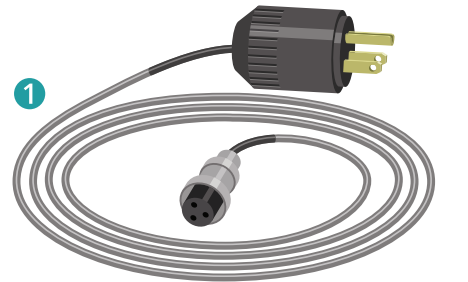

## Tools & Accessories Needed

- A Wire Strippers
- B Wire Cutters
- C Flat-Head Screw Driver
- D Phillips-Head Screw Driver
- E Cable Ties
- F Self-Adhesive Cable Tie Mounts
- G Ethernet Cable

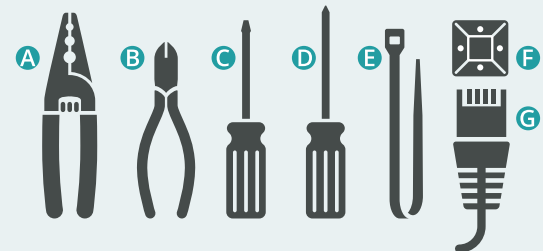

- OPTIONAL TOOLS\***
- H Center Punch
  - I Deburring Tool
  - J Drill
  - K Unibits/Stepped Drill Bits
  - L Strain Relief
  - M Rubber Grommet

\*Optional tools are only required if the current sensors and Power Analyzer are located external to the control panel.

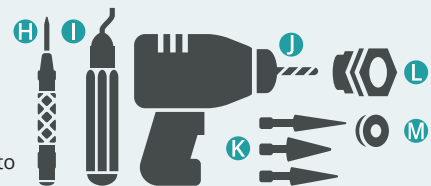

## Current Sensors

### STEP 1

#### Opening Current Sensor

Place thumb or finger under latch and lift upward.

Process similar for all current sensors.

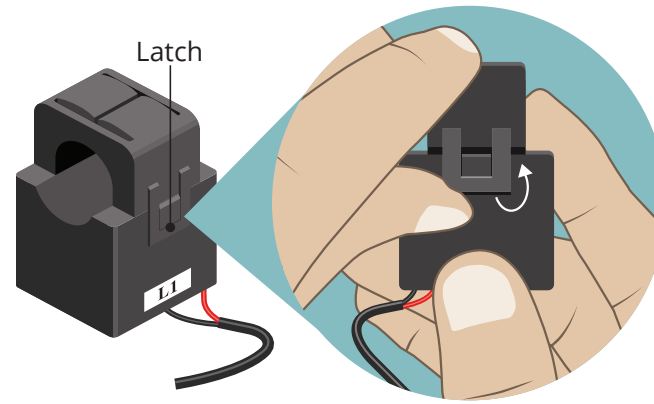

### 1

### 2

### 3

#### How To Attach Current Sensor

- 1 Lift latch to open
- 2 Place wire in groove
- 3 Close top and snap latch to lock

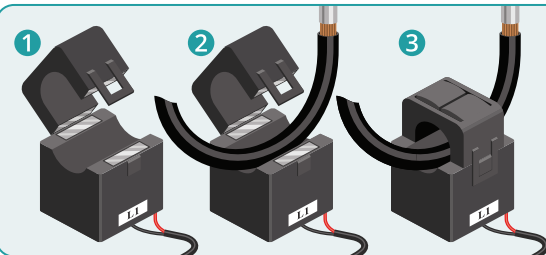

### STEP 2

#### Installing L1, L2 and L3 Current Sensors

From the three-phase equipment/motor terminals attach:  
 L1 sensor to line 1  
 L2 sensor to line 2  
 L3 sensor to line 3  
 Make sure the arrow is facing the primary current direction.

Arrow on back indicates current direction.

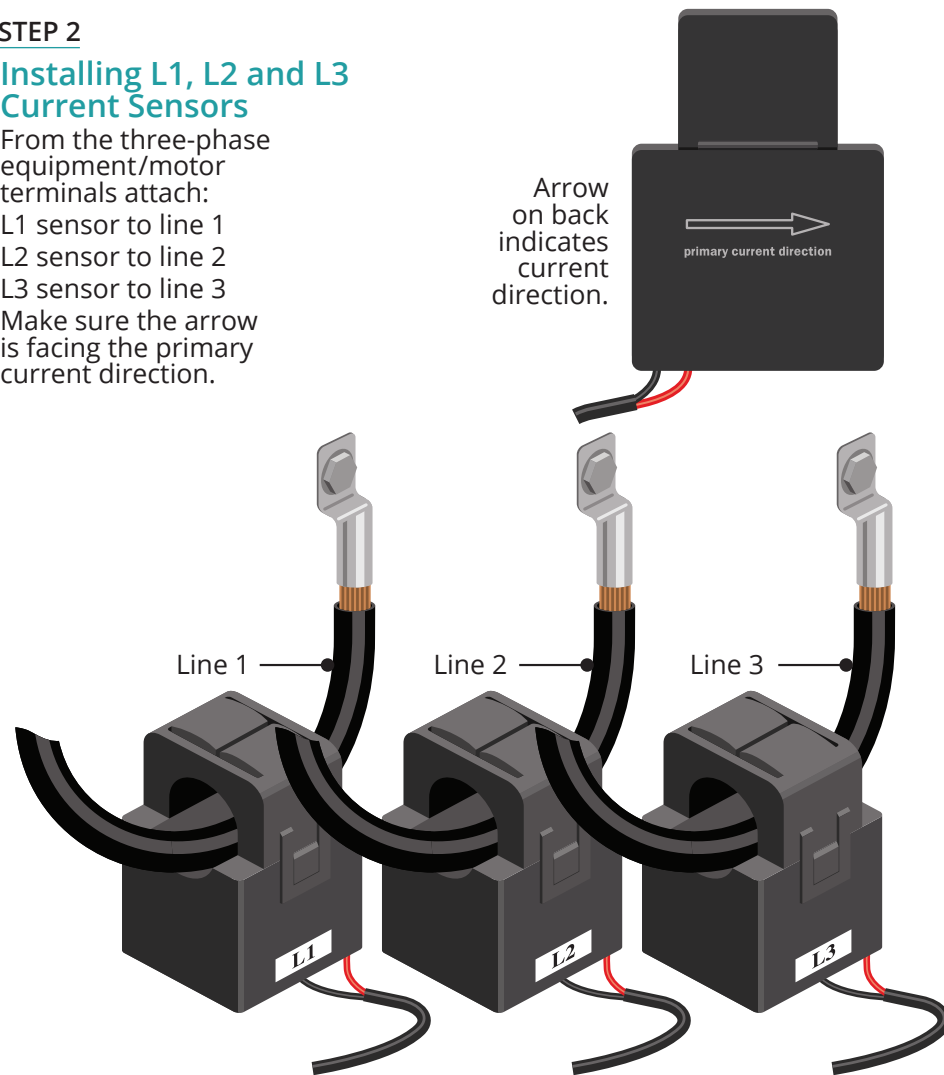

## Voltage Connections

### STEP 3

#### Alligator Clip Connection

There are 3 alligator clips for voltage tapping from the three-phase equipment/motor terminals.

Voltage Alligator Clips	Phase
BLACK	L1/BLA
RED	L2/RED
BLUE	L3/BLU

#### CAUTION

Failure to connect the voltage clips in the proper sequence could cause equipment damage or failure.

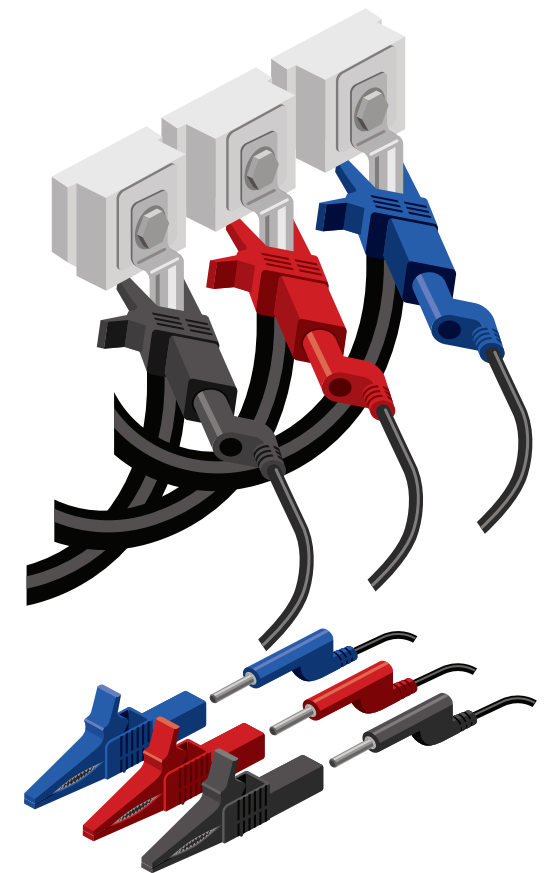

#### Hard Wire Connection

If you are permanently installing the Power Analyzer voltage clips or have space restrictions you may choose to hard wire the supplied leads rather than use the alligator-style voltage clips.

Voltage Leads	Phase
BLACK	L1/BLA
RED	L2/RED
BLUE	L3/BLU

