



Safety Notices/Disclaimer	1
Liability	2
Introduction	3
Accessories	3
Unit Overview	3
Features	4
Specifications	4
Declaration of Conformity	4
External Communication Connections	5
Printer	6
Unpacking the Instrument	7
Unlock Shipping Brackets	7
Instrument Placement	10
Leveling Instrument.....	10
Installation	11
Connecting AC Power	11
Grain Drawer	12
Optional Bottomless Grain Drawer	12
Navigation	13
Using External Devices	13
Touch Screen Button Functions	14
Home	14
Power Off	14
Initiate	14
Print	14
Back	14
Abort	14
Enter	14
USB	14
User	14
Instrument Information	15
LCD Display Touch Screen Calibration	15
Keypad	15
Clean	15
Password Restrictions	17
Setup	19
Product	20
Create Product	21
Modify a Product's Bias and Slope	21
Delete Product	23
Load New Product	24
Administrative Settings	26
To Change a Known User Name/Password	26



Setup continued	27
System Setup	27
Printer Setup	27
Adding a Header and Footer to Ticket	29
Language and Keyboard Settings	30
Locale Setting	31
Sample Setup	32
Setup continued	32
Result Setup	34
Export Data Format	36
Time	37
Units	38
Owner Data	39
Service Data	40
LCD Display Touch Screen Calibration	41
Data Storage Capacity	42
Check Scale	43
Network Setup	46
Update Instrument	46
Startup	47
Power Down	48
Analyzing Grain	49
User Login (Optional)	49
Selecting Product	51
Performing a Grain Analysis	51
Hopper Level Indicator	52
General Cleaning Tip	55
Database Memory Messages	56
Database Memory Full Warning	56
Out of Memory	57
Data Drive Memory Low	57
Data Drive Out of Memory	58
Results	59
Refine Query Options	60
Query Only Last Number of Records	60
Print Only Last Number of Records	60
All Products	61
Product Like	61
User Like	61
Sample ID Like	61
Unable to Show Query Results	61
View Products	62
Grain Calibrations	63
Diagnostics	65



Maintenance	67
External Cleaning	67
Internal Cleaning	68
Daily Clean Method	68
Extensive Cleaning Method	70
Cleaning the Temperature Sensor Probe	73
Troubleshooting	79
Warranty	83





SAFETY NOTICES

Safety notices are one of the primary ways to call attention to potential hazards. An absence of specific alerts does not mean that there are no safety risks involved.



This Safety Alert Symbol identifies important safety messages in this manual. When you see this symbol, carefully read the message that follows. Be alert to the possibility of personal injury or death.

⚠ WARNING

Use of the word **WARNING** indicates a potentially hazardous situation which, if not avoided, could result in death or serious injury.

⚠ CAUTION

Use of the word **CAUTION** with the Safety Alert Symbol indicates a potentially hazardous situation which, if not avoided, may result in minor or moderate injury.

CAUTION

Use of the word **CAUTION** without the safety alert symbol indicates a potentially hazardous situation which, if not avoided, may result in equipment damage.

DISCLAIMER

DICKEY-john reserves the right to make engineering refinements or procedural changes that may not be reflected in this manual. Material included in this manual is for informational purposes and is subject to change without notice.



LIABILITY

DICKEY-john designed the GAC[®] 2500 to measure oilseed and grain moisture content. We rigorously test and calibrate each instrument before it leaves the factory. Use of the instrument in the field, however, is subject to environmental and operating conditions beyond our control. As a result, we are unable to take responsibility for those conditions and any damages that might follow incorrect results due to those environmental or operational conditions.

Therefore, we expect the operator to take responsibility to assure that the results of the testing is as accurate as possible by following approved maintenance procedures on a regular basis, by cleaning the instrument and its sensors on a regular and as-needed basis depending on the amount of dust, dirt, and debris encountered in the instrument's use, by monitoring performance using daily check samples, and by adhering to the check procedures set forth in the manual. As with any kind of sophisticated equipment, optimal results depend in part on proper cleaning and maintenance.

For questions concerning these issues, refer to the product warranty, or call your DICKEY-john representative.



INTRODUCTION

The DICKEY-john Grain Analysis Computer GAC® 2500-AGRI quickly tests grain and automatically calculates moisture content, temperature, and test weight (bulk density) of the sample. The unit prompts for sample loading, tests the sample, and displays the results.

NOTE: Visit dickey-john.com website for HELP videos on proper instrument setup, performing a grain analysis, and maintenance routines.

ACCESSORIES

The following list of components are included with the unit and can be ordered as replacement parts:

- 110V power cord p/n 203150002
- 220V power cord p/n 203150005 (international optional/not currently included)
- Operator's manual p/n 11001-1626
- Cleaning brush p/n 206410003
- Grain drawer p/n 468071541
- Grain drawer bottomless (optional) p/n 468071542

UNIT OVERVIEW

1. Power (on/off) button
2. Hopper
3. Hopper full sensors
4. Touch screen display
5. USB connections (2) front (2) back
6. Sample drawer
7. Bubble level
8. Adjustment feet (4)

Figure 1

GAC2500-Agri Overview (Front of Unit)

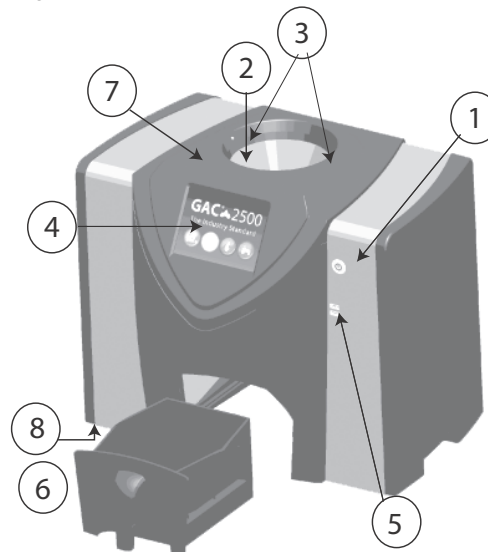



FEATURES

- Color touch screen display guides users through testing and setup
- Easy-to-use user interface
- Fast, accurate grain analysis
- One core calibration for all grains
- Stores up to 8 grain calibrations
- Alpha/numeric sample identification with the ability to add an optional extended keyboard or bar code reader via USB
- Error messages display when out-of-limits moisture, grain weight, or grain temperature occur
- Customizable work environment
- Optional password protection
- Storage of 3,000 grain tests
- Internal memory capacity to handle future upgrades
- Printing capabilities
- A variety of external communication options

SPECIFICATIONS

- Operating temperature: 36 to 113 degrees F (2 to 45 degrees C)
- Power: 110/220V, 50/60 Hz, 30/35 VA
- Humidity: 20 to 90% noncondensing
- Grain temperature: -4 degrees F to +113 degrees F (-20 degrees to +45 degrees C) depending on grain calibrations
- Storage/transit temperature: -4 to +140 degrees F (-20 to +60 degrees C)
- Moisture range: 5 to 45% (grain dependent)
- Approximate weight: 25 lbs.
- Approximate dimensions: 17"H x 19"W x 14"D

DECLARATION OF CONFORMITY

The GAC® 2500-AGRI conforms with the provisions of the following directives and regulations:

- EN2006/95/EC Low Voltage Directive
- EN2004/108/EC EMC Directive
- EN61010-1 Safety requirements for electrical equipment for measurement, control, and laboratory use operating at a maximum altitude of 6562 feet (2000 meters)
- CAN/CSA - C22.2 NO. 61010-1 and ISA - 82.02.01 (IEC 61010-1 MOD) and UL61010-1



EMC

EMC conformity to EN 61326-1:2006 (Electrical Equipment for Measurement, Control, and Laboratory use) as follows:

Immunity

- Radiated RF field EN 61000-4-3 (2002)
- Conducted RF voltage EN 61000-4-6 (1996) + A1 (2001)
- Fast transient/burst EN 61000-4-4 (2004)
- Electrostatic discharge (ESD) EN 61000-4-2 (1995) + A1 (1998) + A2 (2001)
- Surge EN 61000-4-5 (1995) + A1 (2001)
- Voltage dips and interruptions EN 61000-4-11 (2004)

Emission

- Radiated emission CISPR II:2003 + A1: 2004
- Conducted emission CISPR II:2003 + A1: 2004

EXTERNAL COMMUNICATION CONNECTIONS

- 4 USB connections (2 in front, 2 in back) to connect a keyboard, mouse, printer or flash drive. Up to 3 devices can be active on USB.
- 1 USB connection to connect the GAC[®] 2500-AGRI to a computer for software download to the device, installing calibrations, or remotely accessing data from the instrument.
- 1 ethernet connection to connect the GAC[®] 2500-AGRI to a PC or network for downloading of software to the device, installing calibrations, or remotely accessing data from the instrument.
- 1 RS232 serial port printer connection

Figure 2

External Communication Connections (Back of Unit)



CAUTION

Appropriate space must be left around the input power connector to allow easy disconnection at the unit.



PRINTER

An optional printer that is RS232 compatible or a USB printer that supports Printer Control Language (PCL) can connect to the GAC[®] 2500-AGRI to print test data results to a ticket. The ticket can be setup to include the facility name and address, product, date and time, sample ID, customer ID, grain calibration date, percent moisture, grain temperature, test weight, and errors. The data can be automatically printed at the end of each measurement cycle or manually initiated by pressing the **Printer** button.

Figure 3

Printer





UNPACKING THE INSTRUMENT

UNLOCK SHIPPING BRACKETS

The GAC® 2500 instrument contains (2) shipping brackets that secure the measurement cell during shipping. After unpacking the instrument, the shipping brackets must be unlocked and placed in the operating location before proceeding to setup and operation.

To unlock shipping bracket:

1. Remove Allen wrench from upper foam packaging insert.

Figure 4

Remove Allen Wrench

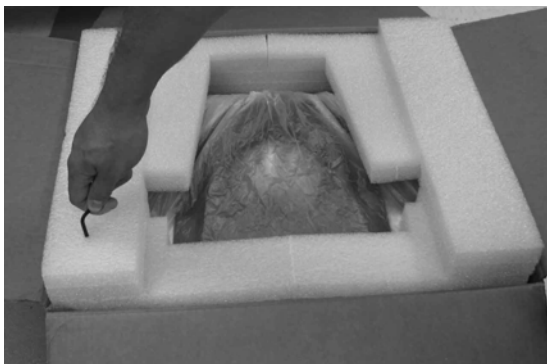

2. Carefully remove unit from packaging and place on a flat, sturdy surface.
3. Remove grain drawer and set aside.
4. Place unit on its backside. Shipping brackets are located on the left and right side wall.

Figure 5

Remove Grain Drawer and Locate Shipping Brackets

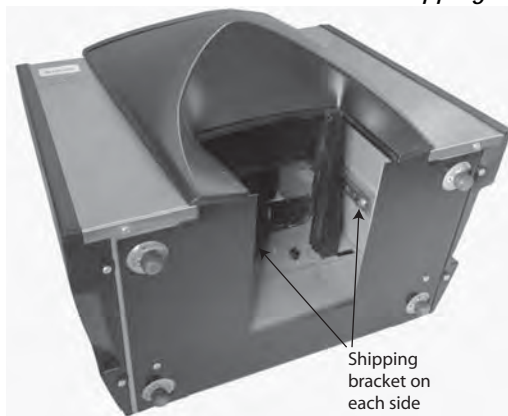



5. Loosen hex bolt from the shipping locked location.

Figure 6

Loosen Hex Bolt from Bracket



6. Remove hex bolt and set aside.

Figure 7

Remove Hex Bolt



7. Press down on the bracket to release.

Figure 8

Press Down on Bracket





8. Slide bracket forward and align with operating location.

Figure 9

Slide Bracket Forward

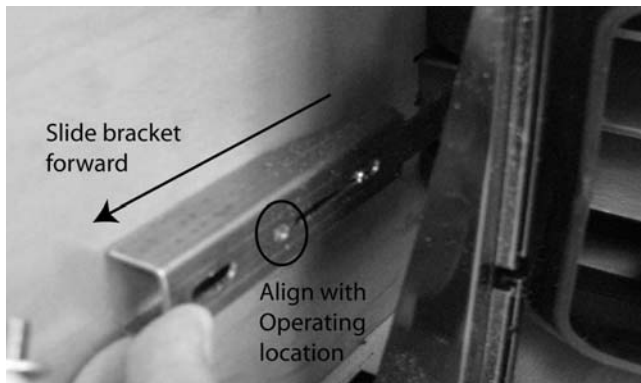

9. Insert hex bolt into operating location hole and securely tighten using the Allen wrench.

Figure 10

Insert Hex Bolt and Tighten



10. Perform the same procedure to the other bracket.
11. Once both brackets are securely tightened to the operating location, place unit upright.

IMPORTANT: If for any reason this unit is shipped or transported, the hex bolts should be removed from the operating location and secured back to the shipped locked location to protect the measurement cell during transit!



INSTRUMENT PLACEMENT

Place the instrument in a clean environment that is protected from rapid changes in ambient temperature and vibration. Avoid a hazardous (classified) location as defined in Article 500 of the NFPA Handbook of the National Electrical Code.

- Instrument should be placed on a flat, level surface that does NOT exceed more than 1 degree of tilt (left to right and front to back).

CAUTION: A surface that exceeds this requirement can effect measurement results.

- Surface should be vibration free.

CAUTION: Vibration from other machines or devices can effect measurement results.

LEVELING INSTRUMENT

A bubble level located on the top surface of the instrument aids in leveling the instrument for optimum test weight measurement.

- Adjust the feet (4) on instrument bottom until bubble is in the center of the level.



INSTALLATION

The GAC[®] 2500-AGRI unit requires minimal setup. The unit is fully assembled and ready for operation after attaching the AC power cord and inserting the grain drawer.

NOTE: After unpacking, visually inspect for damage occurring during transit. Save all packing materials until inspection is complete. If damage is found, file a claim with the carrier immediately and notify your DICKEY-john sales representative.

Figure 11

Unit Dimensions

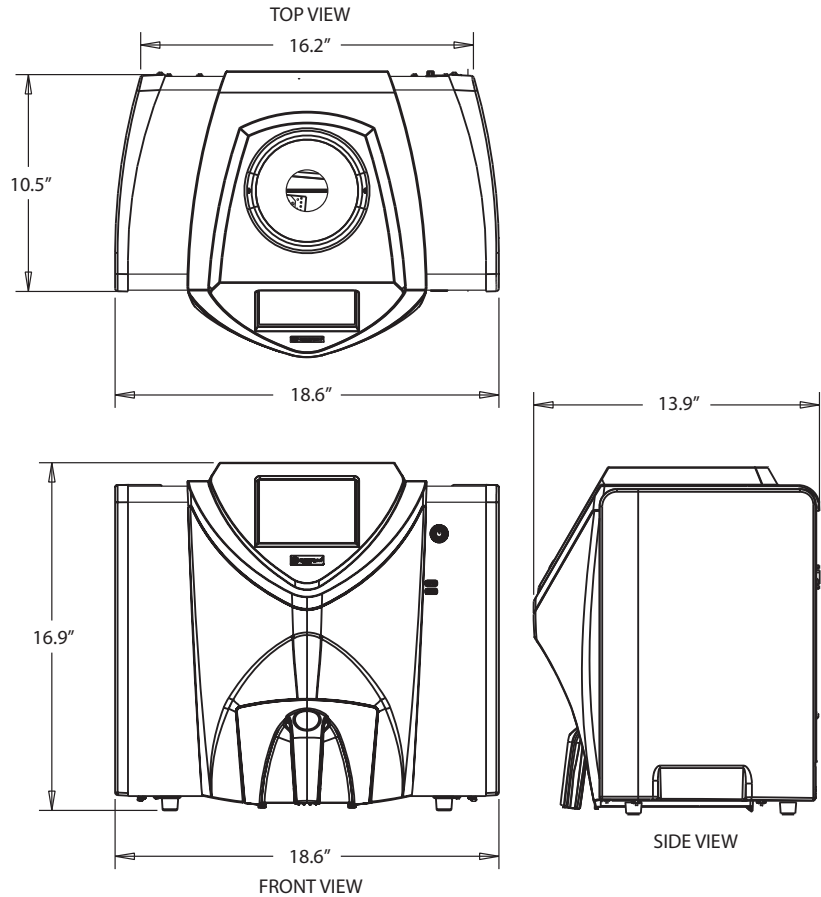

CONNECTING AC POWER

1. Securely connect power cord into the AC plug connection (Figure 2) located on the back of the unit.
2. Plug the male end into an appropriate 3-wire (grounded) outlet.

CAUTION

The grounding pin on the line cord connects directly to the GAC[®] 2500-AGRI frame. When using an adapter ensure the grounding wire is connected properly to a good earth ground to prevent a shock hazard.



GRAIN DRAWER

The unit is equipped with a standard grain drawer with handle. An optional bottomless grain drawer is available for purchase from DICKEY-john.

OPTIONAL BOTTOMLESS GRAIN DRAWER

Part Number: DRAWEROPGAC2500

A bottomless grain drawer is used with a flow-through work counter that allows the tested grain samples to fall through to a larger container below. The size of the hole must be at least equal to the drawer dimension and located directly beneath the grain sample drawer.

NOTE: Contact DICKEY-john Technical Support at 1-800-637-3302 for additional information on grain drawers.

Figure 12
Flow Through Work Counter

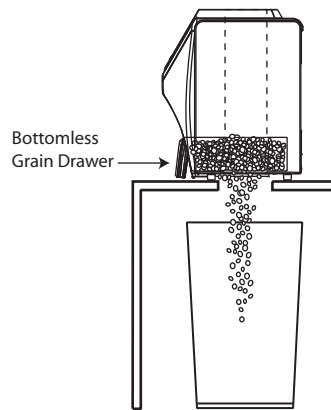



NAVIGATION

The user interacts with the GAC[®] 2500-AGRI via the LCD touch screen display. Screen interaction by finger touch or using a dull, pointed object, such as a stylus or pen is recommended.

Refer to the Maintenance section for how to properly clean display.

CAUTION

Do not use any sharp objects on the display. Damage to screen can result.

The following methods are used to navigate through and interface with the unit:

1. Text input boxes
2. Keypad icon (enables keyboard)
3. Buttons
4. Keyboard

Figure 13

LCD Touch Screen Display

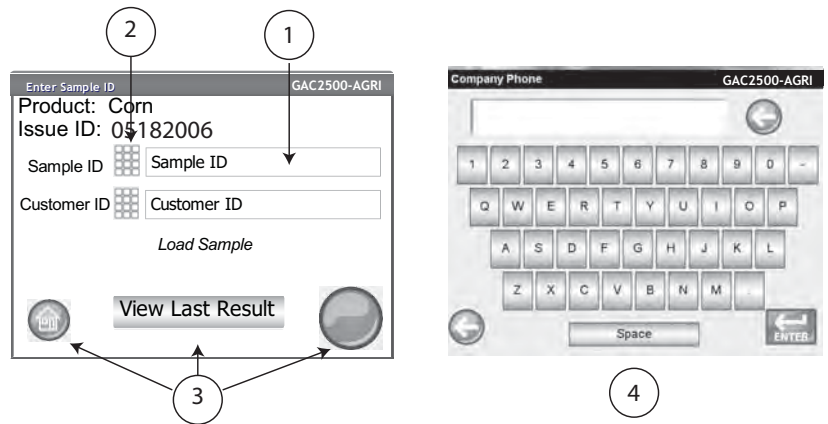

USING EXTERNAL DEVICES

The following external devices can be used to enter data and navigate through the screens by connecting to the USB ports (2 front/2 back):

- keyboard
- mouse
- barcode scanner



TOUCH SCREEN BUTTON FUNCTIONS



HOME

Home button is available on most screens and, when pressed, returns to the Main Menu screen.



POWER OFF

Power Off button turns the system off from the touch screen display. The system must be turned on using the On/Off button located on the front panel but can be turned off from either the screen display or the On/Off button.



INITIATE BUTTON

The **Initiate** button is used to analyze grain and has 3 states of operation:

Green = proceed to begin test

Yellow = an action is required to proceed

Red = system cannot process; error has occurred



PRINT

Print button allows printing test results to a local printer. Refer to the Setup section for print requirements.



BACK

Back button returns to the previous screen.



ABORT

Abort button dumps grain from hopper, empties the cell, and aborts test.



ENTER

Enter button accepts action taken and proceeds to next screen.



USB

USB button is used when connecting the unit direct to a computer for downloading software and installing calibrations.



USER

User button appears on the Main Menu screen only if a User ID has been enabled in System Setup. Requires a tester to enter a User Name before a grain analysis can proceed and will print on a ticket.



INSTRUMENT INFORMATION

Instrument Information button appears on the Main Menu screen providing details regarding unit service date, serial number, and software version. Typically used for troubleshooting purposes.



LCD DISPLAY TOUCH SCREEN CALIBRATION

Display Touch Screen Calibration button re-calibrates the display when screen responsiveness does not occur effectively to a finger touch or stylus.



KEYPAD

The **Keypad** icon appears on those screens that require text entry. Pressing the Keypad icon opens the virtual keyboard for typing text on the screen. The virtual keyboard is used when an external keyboard, mouse, or barcode scanner are not available.

Figure 14

Keyboard



CLEAN

Clean button appears on the Instrument Information screen and allows cleaning the cell and door using an automated process. During the cleaning sequence, the hopper door automatically opens.





PASSWORD RESTRICTIONS

Setting an Admin user name and password to restrict system settings to be controlled by an administrator are optional. The unit is shipped with an Admin user name and password setting of "GUEST".

Keeping the Admin user name and password as "GUEST" retains the unit in open access mode allowing any user to enter System Settings and modify unit settings.

IMPORTANT: To restrict access to System Setup that affects overall unit functionality, a new Admin user name and password must be created.

To Create an Admin User Name and Password:

1. At the Main Menu screen, press the **Setup** button.
2. Leave the Admin Username and Password as GUEST and press the **Enter** button.
3. At the Setup screen, press the **Admin Settings** button.
4. At the Enter New Password screen, press the Admin Username keypad icon and enter an administrator user name.
5. Press the **Enter** button to accept.
6. Enter a Password and re-enter password to confirm.
7. Press the **Enter** button to accept.

NOTE: An external keyboard, barcode scanner, or mouse can be used to enter data into the unit.

Once a new password is created, the unit is configured so that an administrator name and password is required to gain entry into the System Setup screens. Password and User Name can be any combination of letters and numbers.

Refer to Administrative Settings in the System Settings section to change an Administrator user name and password or reset to open access.

IMPORTANT: The following words should be not used as User Names: (ROOT, GUEST, REBOOT, RESET).



Figure 15
Password Screen

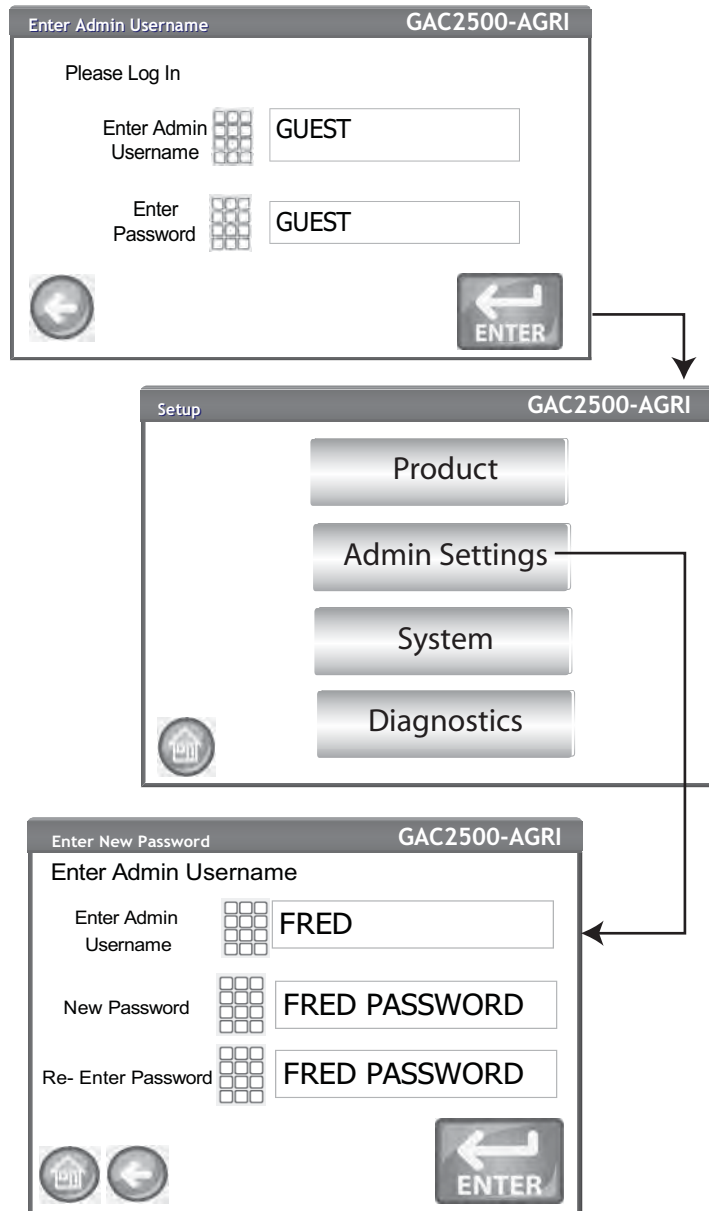



SETUP

Setup establishes basic unit operating parameters and allows customization of the user interface by:

- Editing an existing product and loading new products (Product button)
- Setting administrative levels (Admin Settings button)
- Setting system parameters for external devices, language/locale preferences, time/date, sample result output, unit measurement, sample/customer ID's, delete records, and printing formats (System button)
- Diagnostics for troubleshooting and unit information (Diagnostic button)

To View Setup Options:

1. At the Main Menu screen, press the **Setup** button.
2. Enter User Name and Password, if required, and press the **Enter** button to display the Setup screen. If defaulted to Name (Guest) and Password (Guest) press the **Enter** button.

Figure 16

Setup Screen

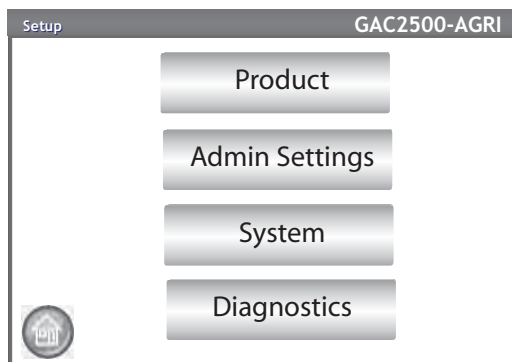



PRODUCT

The Product screen allows editing an existing product to create a new product, loading new products into the instrument via USB, and the deletion of products.

To Select a Product:

1. At the Product Setup screen, press the **Edit Existing Product** button.
2. At the View Product Setup screen an alphabetical product list appears. Press the desired product to highlight.
 - Press the **Up** or **Down** button to display additional products.
3. Press the **Enter** button to select. Once the product is selected, the product's parameters display in a table.

Figure 17

Edit Existing Product

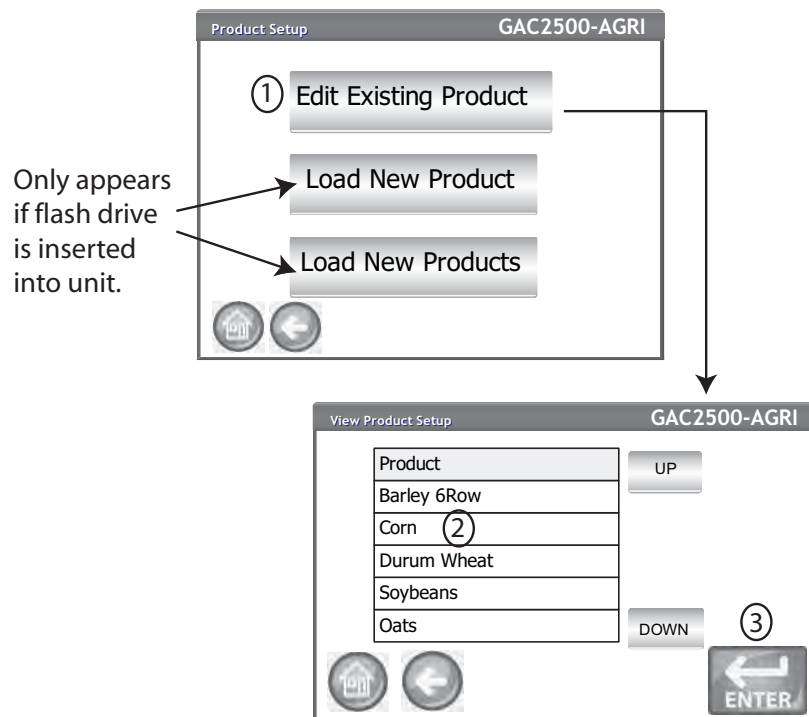



CREATE PRODUCT

A new product can be created by copying a similar product's parameters. Creating a new product name and Issue ID prevents an existing product's parameters from being overwritten.

The instrument holds 8 calibrations. A stored calibration must be removed if creating a new product will exceed the maximum 8 calibrations allowed.

NOTE: An external keyboard, barcode scanner, or mouse can be used to enter data into the unit.

To Create a Product:

1. At the View Product Setup screen, press the **Create** button.
2. At the Rename Product screen, the product name and NEW appears as the default name.
3. Press the keypad icon to enter a different product name, if desired.
4. A new Issue ID is automatically defined for the new product. Press the keypad icon to enter a different Issue ID, if desired.
5. Press the **Enter** button to save.

Figure 18

Creating a Product Screen

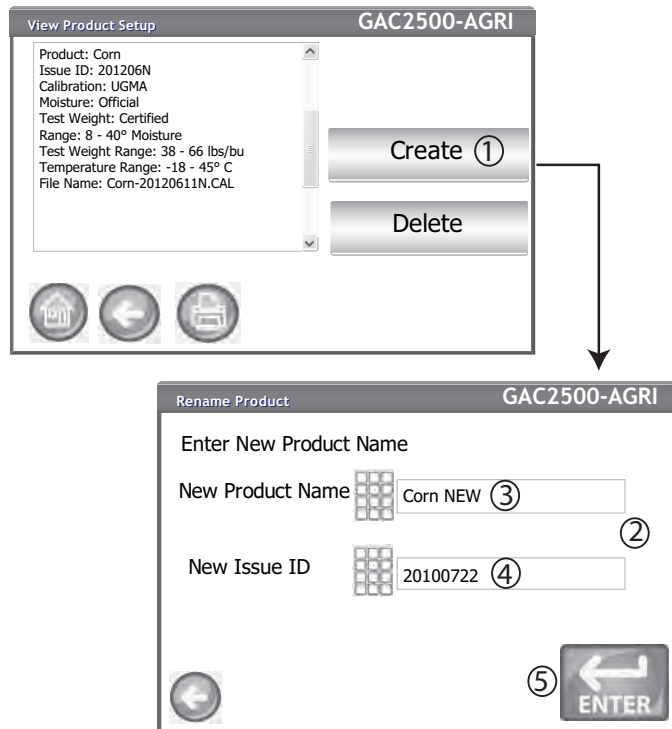

MODIFY A PRODUCT'S BIAS AND SLOPE

After a new product is created, that product's moisture bias, test weight bias, moisture slope, and test weight slope can be modified.

*NOTE: A product's detail at the View Product Setup screen can be printed by pressing the **Print** button.*

To Modify a Product:

1. At the View Product Setup screen, press the **Edit** button.



2. At the Edit Product screen, press the keypad icon to modify a product's bias and/or slope parameters.
3. When finished, press the **Enter** button.
4. Confirm product replacement by pressing the **Replace** button at the Product Already Exists screen.
 - The **Skip** button returns to the previous product's bias and slope setting.
5. The new bias and slope appears in the product table on the View Product Setup screen. The product name and Issue ID will remain the same.

NOTE: An external keyboard, barcode scanner, or mouse can be used to enter data into the unit.

Figure 19
Edit Slope and Bias

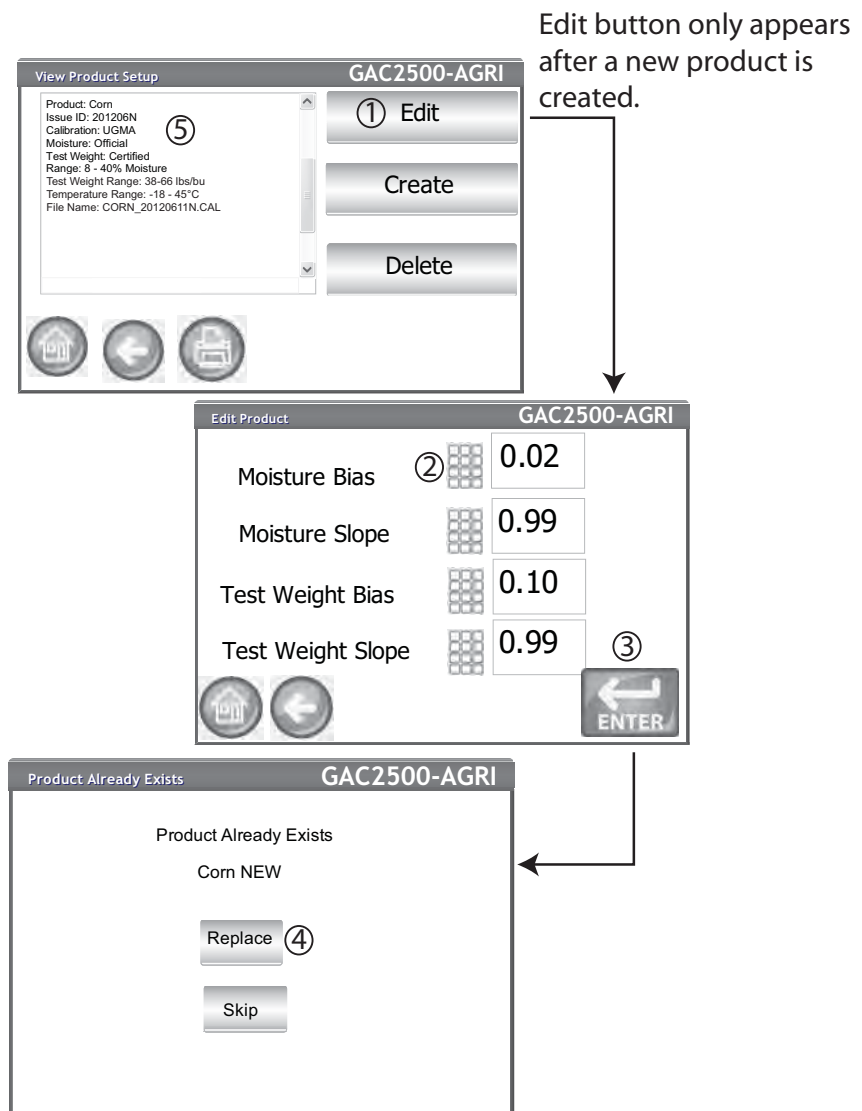



DELETE PRODUCT

A product and its calibrations can be deleted so that it does not appear on the active user screens. A product and its history is stored in the unit's database.

Deleting a Product:

1. At the View Product Setup screen, press the **Delete** button.
2. At the Delete Product screen, press the **Enter** button to confirm deletion.

Figure 20

Delete Product Screen

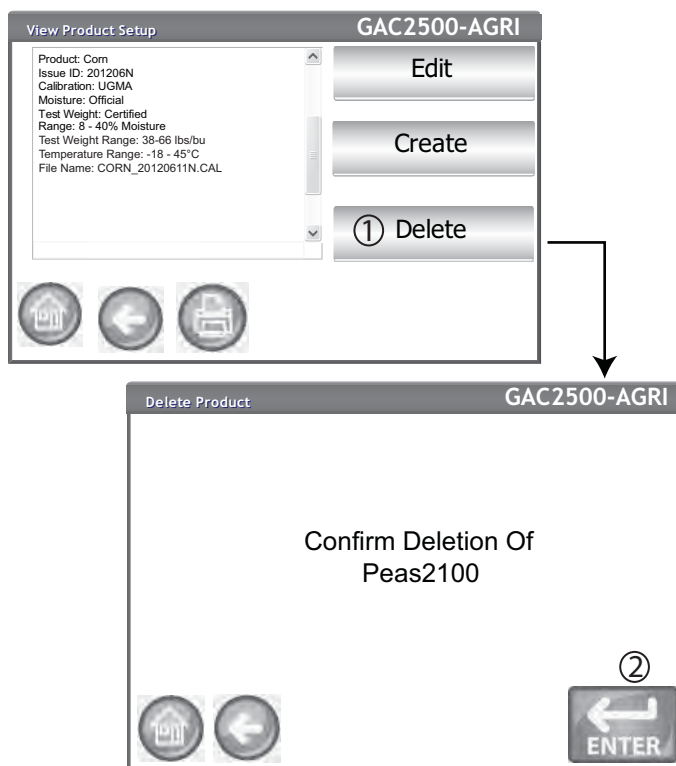



LOAD NEW PRODUCT

New product calibrations are loaded to the GAC[®] 2500-AGRI using a USB memory device. The **Load New Product** buttons only appear when a USB memory device is inserted in the unit.

To Load a Single Product:

1. Insert the USB memory device to the unit's USB port on front panel of unit.
2. At the Product Setup screen, press the **Load New Product** button.
3. Navigate to the directory where the product is located, press on the product name to highlight.
 - A single tap is required to select the desired file.
 - Pressing “..” located at the top of the list returns to previous level in the directory structure.
4. Press **Enter** to begin download. A progress bar indicates downloading status.
5. If a product calibration already exists on the instrument, accept the new calibration by pressing the **Replace** button or the **Skip** button to revert to the existing product.

NOTE: Contact DICKEY-john Technical Support at 1-800-637-3302 for assistance with obtaining updated calibrations or with transferring data to the unit.

*Figure 21
Load New Product Screen*

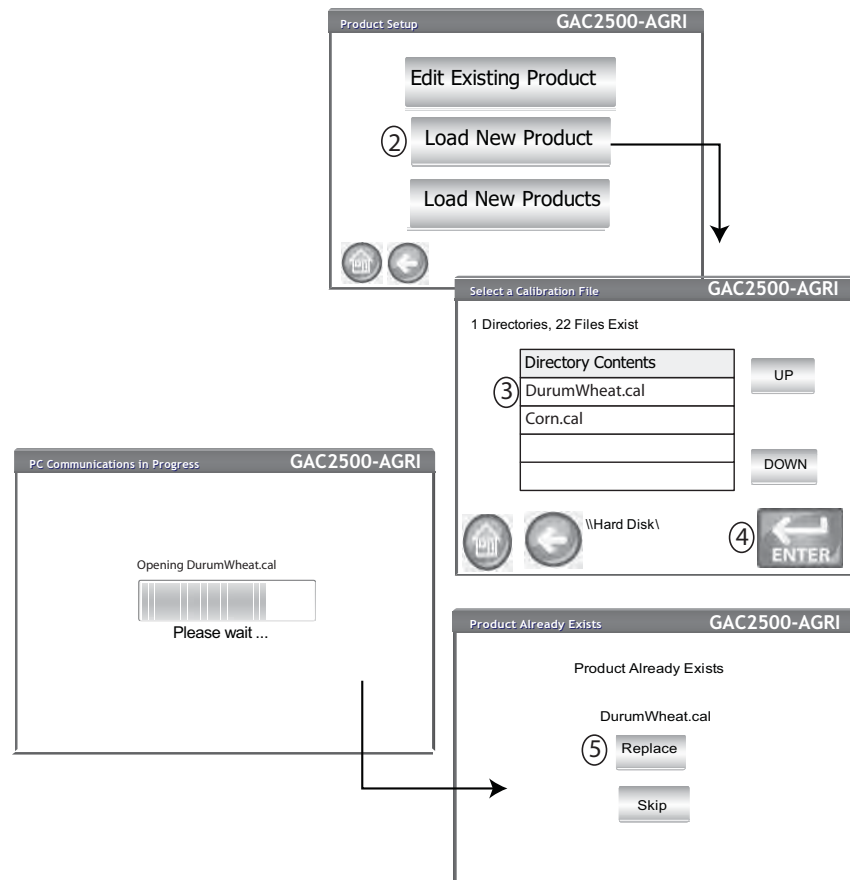



NOTE: Product calibrations are available for download at DICKEY-john's website. [www.dickey-john.com/products/Agriculture/Moisture Testing/GAC2500/Get Support/Downloads](http://www.dickey-john.com/products/Agriculture/Moisture%20Testing/GAC2500/Get%20Support/Downloads).

NOTE: You must know the directory where the files are saved as names do not display.

To Load Multiple Products:

1. Insert the USB memory device to the unit's USB port on front panel of unit.
2. At the Product Setup screen, press the **Load New Products** button to load all products from the selected directory of the memory device or PC.
3. When loading multiple products, navigate through the directory structure and highlight the directory containing the desired products to load. A progress bar indicates downloading status.
 - A single tap selects the desired directory.
 - Pressing “..” located at the top of the list returns to the previous level in the directory structure.
4. Press the **Enter** button to begin download.
5. If product calibrations already exist on the instrument, accept new calibrations by pressing the **Replace** button or the **Skip** button to revert to the existing product.

Figure 22
Load Multiple Products Screens

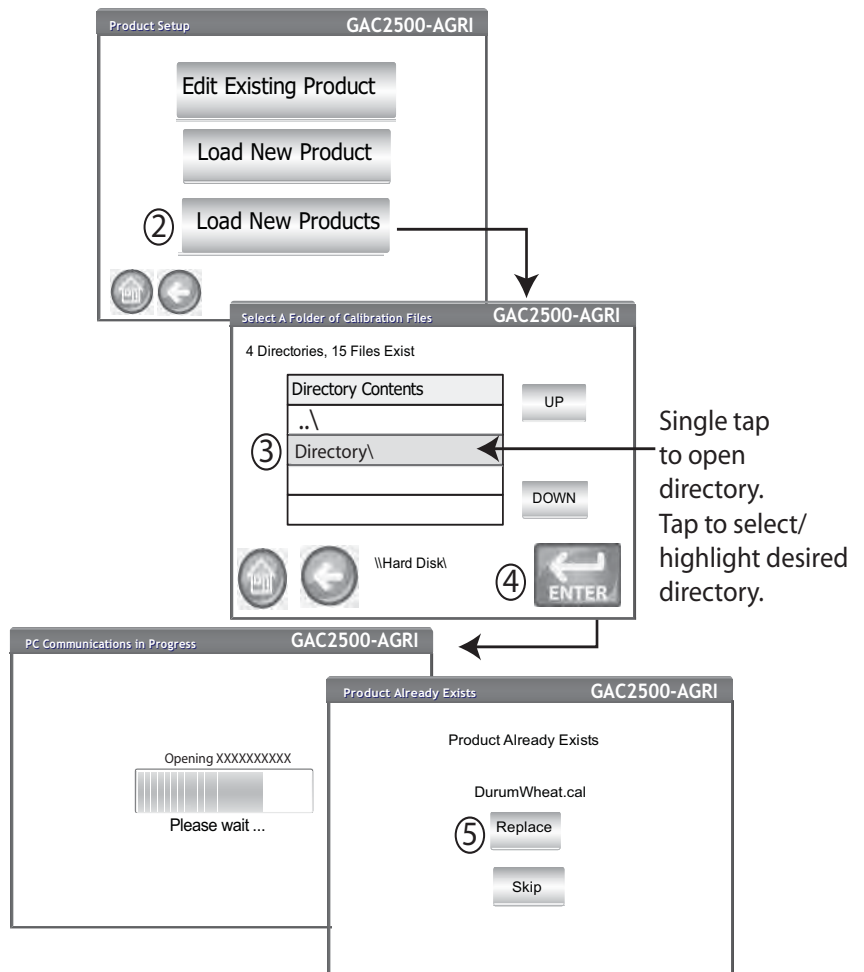



ADMINISTRATIVE SETTINGS

If the instrument is set with an administrator password, the password can be changed to a different admin user name and/or password.

NOTE: Refer to the Setting Password Restrictions section for creating a user name and password.

TO CHANGE A KNOWN USER NAME/PASSWORD

1. At the Main Menu screen, press the **Setup** button.
2. At the Password Login screen, enter existing user name and password.
3. Press the **Enter** button to accept.
4. At the Setup screen, press the **Admin Settings** button to display the Admin Settings screen.
5. Press the keypad icon and enter a new Admin Username.
6. Enter New Password and re-enter password for verification.
7. Press the **Enter** button to accept changes.

The new user name and password is saved when the **Enter** button is pressed.

Figure 23

Reset Username and Password

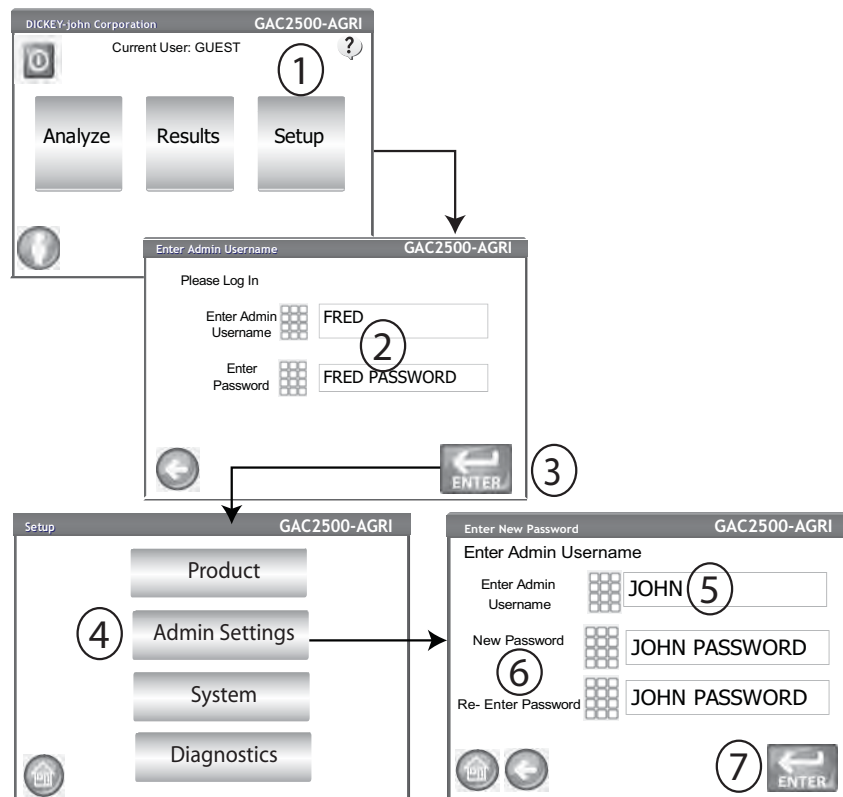

Contact DICKEY-john Tech Support or a local representative to reset instrument to open access mode.



SYSTEM SETUP

System Setup allows customization of the unit's functionality and print settings:

- Printer/scale setup
- Language selection
- Locale selection
- Time and date setup
- Test result settings (automatic, manual return)
- Exporting data format (CSV, Excel)
- Units of measurement
- Sample setup (sample, user ID)
- Owner data (troubleshooting information)
- Service information (technician information)
- Delete database records
- Check scale
- Network setup (technician recommended)
- Update Instrument (technician recommended)

PRINTER SETUP

A USB or RS232 serial port connection is available to connect a printer that prints test data results to a ticket. Streaming data serially is an option when using the USB printing function.

The ticket can be customized to include details as it relates to facility, date, time, testing errors, and product results. The unit can be set to automatically or manually print a ticket at the end of each test.

NOTE: Reference the printer's specifications for correct settings.

To Set Printer Settings:

1. At the System Setup screen, press the **Printer** button.
2. At the Printer Setup screen, enable the check box for the type of connection between the unit and printer:
 - RS232 connection using a Null modem cable
 - PCL USB when connecting to a PCL USB printer
 - Star USB when connecting to an SP712 USB printer
3. For an RS232 connection, select the Baud Rate, Byte Size, Parity, and Stop Bits that match the printer.
4. When sending results to a printer, a Header and Footer can be added to print on each ticket, if desired. Refer to Adding a Header/Footer section.
5. Press the **Test** button to verify that the printer and/or computer and the unit's print settings match for proper communication between the devices.
6. When enabled, **Automatically Print Upon Sample Result** will print a ticket at the end of each test.
7. When enabled, **Include Line Feeds After Print** allows additional line feeds to be added at the end of each ticket after printing.



NOTE: When printing to a database using an RS232 connection and CSV printer output format, a line feed of 1 is required for a carriage return/line feed.

8. Select the output format.
 - PRN20 - Standard 20 column printer output
 - PRN21 - Special 20 column printer output
 - PRN80 - Standard 80 column printer output (80 characters per line)
 - PRN81 - Standard 80 column printer output (81 characters per line)
 - CSV01 - Comma separated variables (requires a 9600 baud rate) selected when test results are sent to a computer.
 - NTEP - A detailed printout that includes engineering data and test results used by the National Conference on Weights and Measures.
9. Select the line termination style.
 - CR - Carriage return
 - CRLF - Carriage return, line feed
 - LF - Line feed
 - LFCR - Line feed, carriage return
10. Press the **Enter** button to accept selections.

Figure 24
Selecting a Printer Type

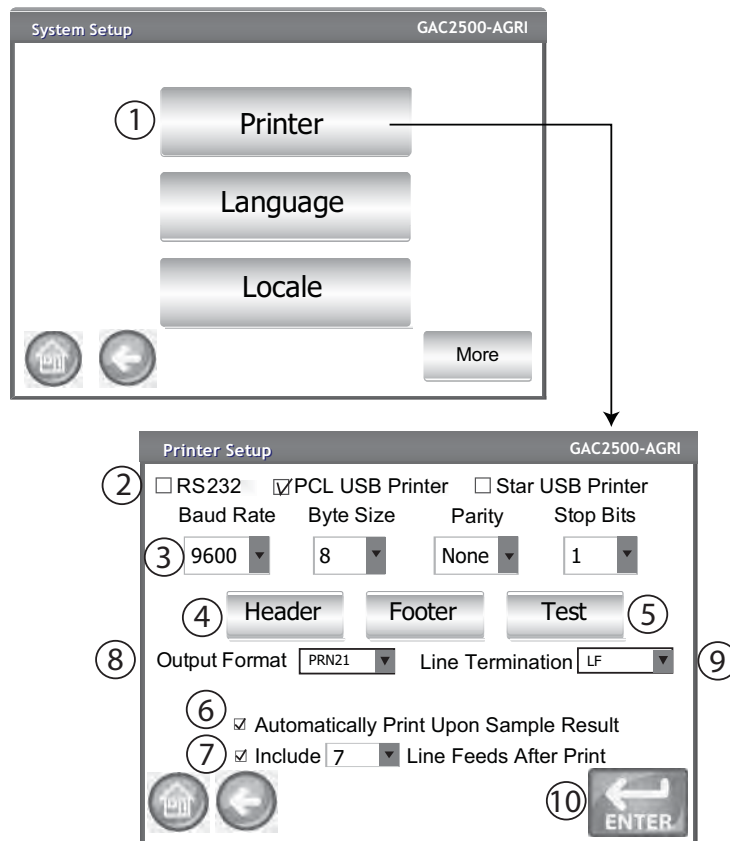



NOTE: An external keyboard, barcode scanner, or mouse can be used to enter header and footer information.

ADDING A HEADER AND FOOTER TO TICKET

Header and Footer text can be added to print on a print ticket. Owner Data text can be selected as the default or customized text can be entered.

To Enter a Header/Footer:

1. At the Printer Setup screen, press the **Header** button.
2. To use the Owner Data address information, enable the check box next to the company name and address. If the owner data text box is blank, owner data information has not been entered at the Owner Data screen and can be entered at the System Setup screen, **Owner Data** button.
3. To enter other text, deselect the Owner Data check box.
4. Press the keypad icon on the screen of the lower text box to open the unit's keyboard and enter desired text.
5. Press the **Enter** button to accept.
6. If desired, enter a footer name by pressing the **Footer** button at the Printer Setup screen. Enter desired information to appear in footer.

Figure 25

Header Screen

Entered at
Owner Data →
screen

Edit Printer Header GAC2500-AGRI

Owner Specific Data

Miller Grain Elevator
72 Depot Road
Anytown, IL USA

Custom Information

Keypad icon

Home, Back, and ENTER buttons



LANGUAGE AND KEYBOARD SETTINGS

Language default is English (US).

Two keyboard styles are available: Qwerty (default) and Standard

Figure 26

Qwerty and Standard Keyboard Styles



To Select a Keyboard Type:

1. At the System Setup screen, press the **Language** button.
2. To select a keyboard type, press the radio button to enable either QWERTY or Standard style.
3. Unit will automatically convert to the selected system language and/or the selected keyboard.

Figure 27

Selecting a Keyboard Style

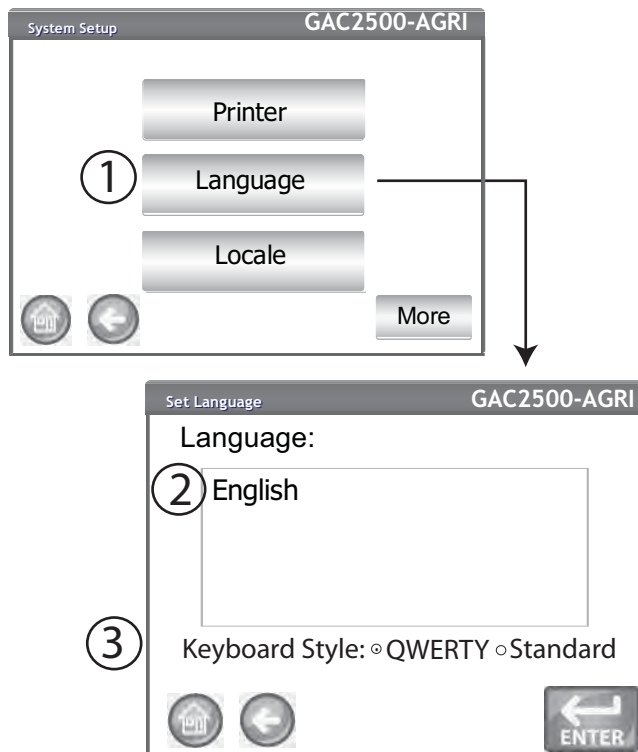



LOCALE SETTING

Locale allows selection of a specific region/area by language that will use the calibrations relevant for that region. The active locale setting appears in the header on the Product Selection screen when analyzing grain. Locale default is United States (US).

Available Locales:

- United States (US)
- Additional locales will be available on future releases. Contact Technical Support at 1-800-637-3302 for release dates and available locales.

To Change Locale:

1. At the System Setup screen, press the **Locale** button.
2. At the Locale screen, press the desired locale to highlight and press **Enter** to confirm.
3. System will automatically convert to the selected Locale setting.

Figure 28

Locale Screen

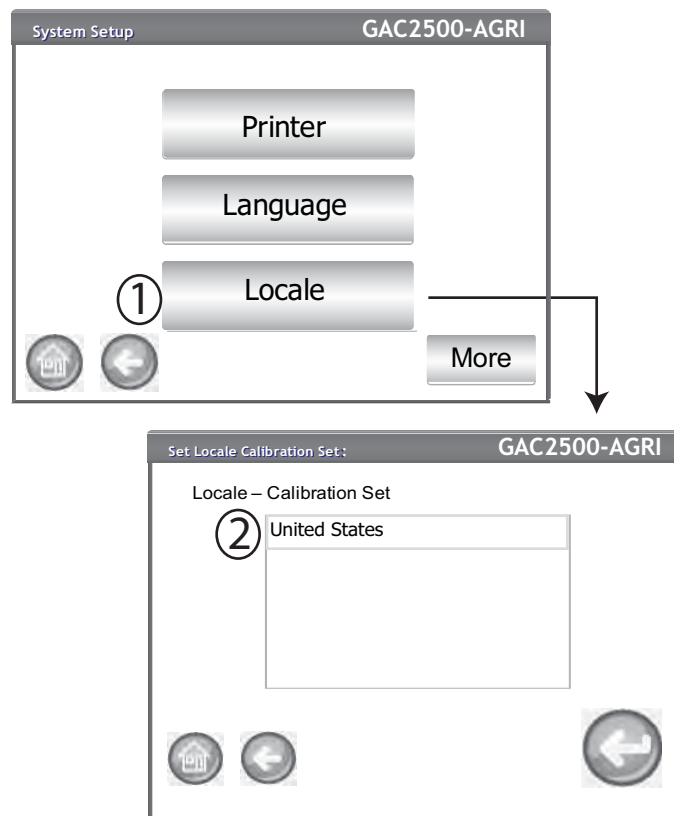



SAMPLE SETUP

A Sample ID, Customer ID, User Name (Login) can be enabled so that a grain sample is identified and saved with this information each time a test is performed.

1. At the System Setup screen, press the the **More** button until the **Sample Setup** button displays.
2. Press the **Sample Setup** button.
3. Enable the check box of desired ID's required when running samples.
4. Press the **Enter** button to accept.

Prompt for Sample ID

The Sample ID screen step can be hidden so that the screen does not appear during analyzation. If a sample or customer ID is required, "Prompt for Sample ID", should be checked.

Prompt for Sample ID can be enabled even when a sample or customer ID is not required so the screen appears during analyzation giving the option to include either of these ID's.

- Enable when a sample or customer ID are required entries before analyzation. A sample ID will be associated with each grain test and prints to ticket.
- Disable to eliminate the Sample ID screen before each analyzation

Sequence Sample ID

Automatic number sequencing to the next higher number will occur with additional tests of the same grain. Sequence Sample ID default is enabled.

Customer ID Required

Requires a Customer ID to be associated with each grain test and prints to ticket. Customer ID default is disabled.

User Login Required

A User Login requires a tester to login with a user name at the Main Menu screen before grain can be analyzed. If a user login is required, the user name entered at the User Login screen is recorded in the unit's database and prints on the print ticket. The **User** button only appears on the Main Menu screen when enabled. User Login default is disabled.





Figure 29
Sample Setup Screen

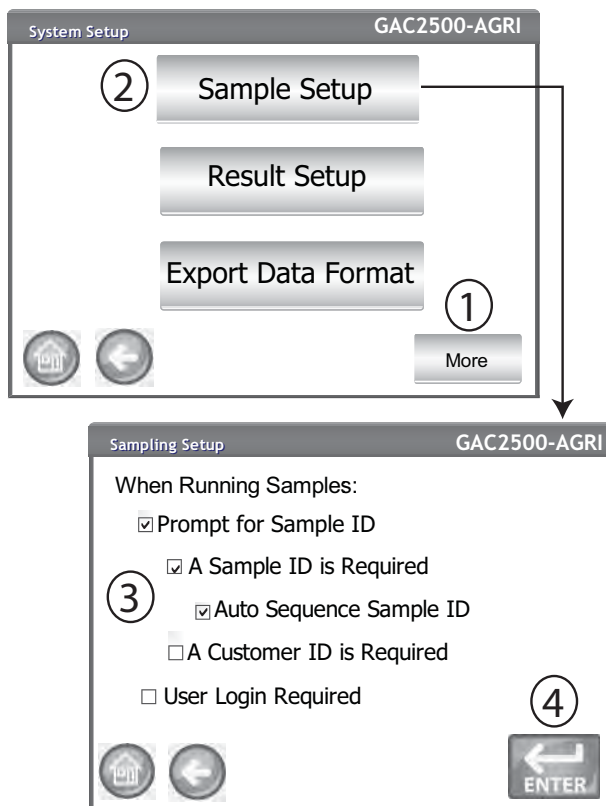



RESULT SETUP

After performing a grain analysis, the unit can be set to automatically advance back to the Sample ID screen from the Analysis Results screen or manually return to this screen with a button press. The unit default is set to manual return. Grain automatically dumps from the hopper in manual or automatic advance mode.

To Display the Sample Return Setup screen:

1. At the System Setup screen, press the **More** button to display and press the **Result Setup** button.
2. Press the **Result Setup** button.
3. Select the checkbox of the desired feature to enable.
4. Press the **Enter** button to accept.



Automatic Return

Advances from the Analysis screen to the Sample ID screen within a specified period of time (4 to 20 seconds) without pressing the **Initiate** button.

Manual Return

Advances to the Sample ID screen to perform another test by pressing the **Enter** button after each test.

Empty Drawer Requirement

A forced empty of the drawer requires a sample dump before proceeding to the next analysis.

Bottomless Drawer in Use

Must be enabled when the bottomless drawer style is used with a flow-through counter to prevent an empty drawer caution from occurring when running tests.

- Grain can also be tested without the grain drawer secured in the unit when Bottomless Drawer in Use is enabled; however, a Drawer Ignored screen appears each time a test is performed and will only proceed to perform test when the **Initiate** button is pressed.

Display Test Weight and Temperature

Displays the test weight and temperature on the Results screen for each test. Both features are defaulted to enabled.



Figure 30
Result Setup Screen

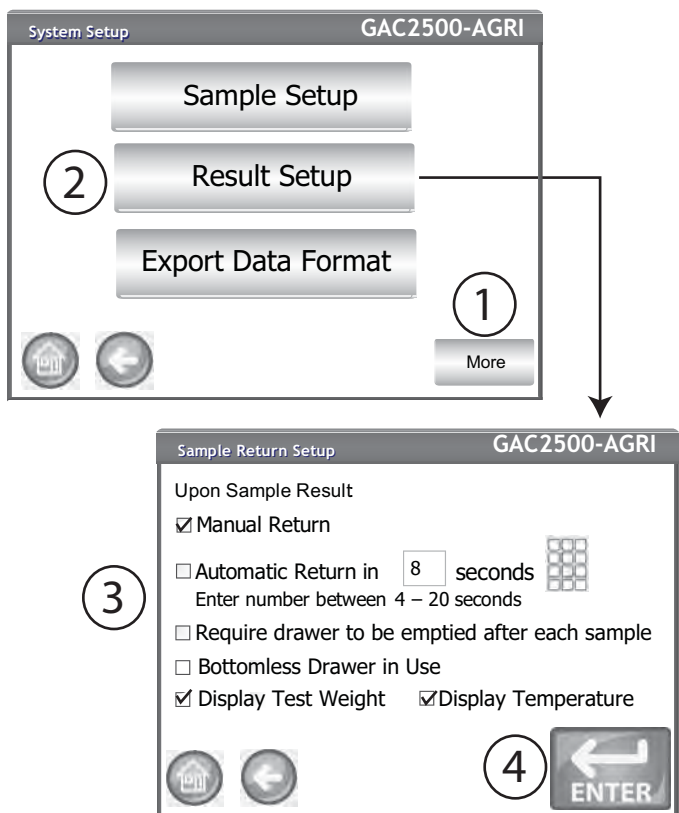



EXPORT DATA FORMAT

Data can be saved for output to a computer in an Excel or CSV format. The unit default is CSV.

1. At the System Setup screen, press the the **More** button until the **Export Format** button appears.
2. Press the **Export Format** button.
3. Enable the check box of the desired output.
4. Press the **Enter** button to accept.

Figure 31

Data Format Screen

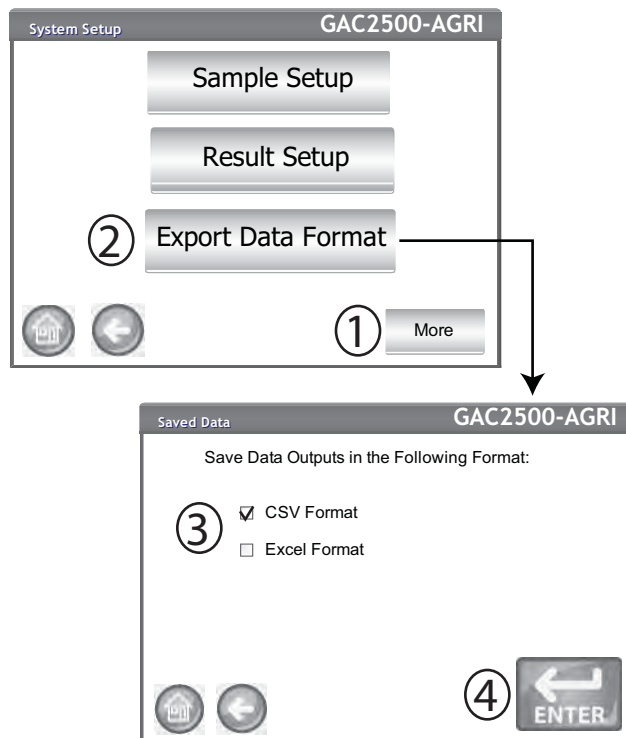



TIME

NOTE: The date can be changed to US or UK format at the Units screen.

1. At the System Setup screen, press the **Time** button.
2. To select a date, press the Date drop down arrow to display calendar.
3. Use arrows to change the month.
4. Enter time using the up/down arrows.
5. Select PM check box, if applicable.
6. Press the **Enter** button when done.

Figure 32

Time and Date Screen

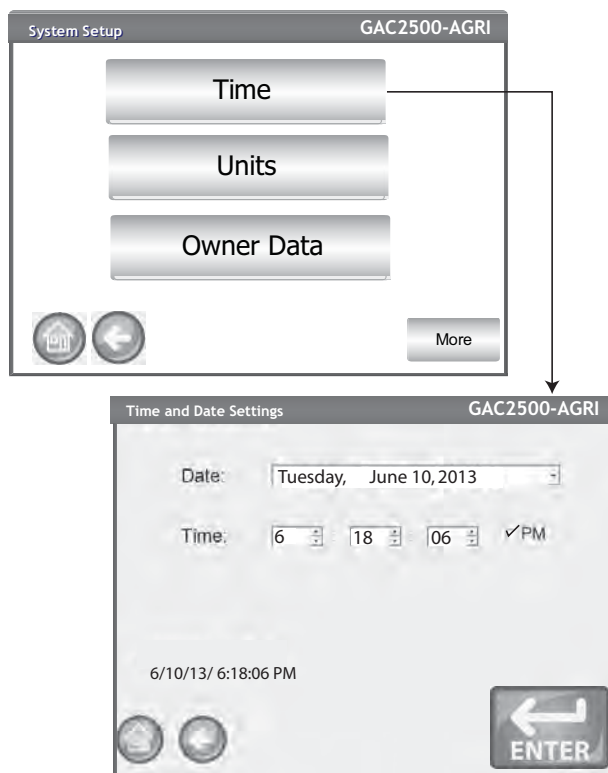



UNITS

The Units screen allows selection of:

- Date format (US or Euro)
- Temperature (degrees F or C)
- Unit measurement for test weight (lb/bu or kg/hl)
- Radix point (, or .)
- Moisture, test weight, and temperature display resolution (tenths or hundredths)

Test Weight defaults to display on the Analysis Results screen but can be removed by disabling at the Sample Setup screen.

Unit defaults:

- Date (US - MM/DD/YYYY)
- Test weight (lbs/bu)
- Temperature (degrees F)
- Radix point (Period - .)
- Moisture (tenths)

To Change Units:

1. At the System Setup screen, press the the **More** button until the **Units** button appears.
2. Press the **Units** button to display the Units Setup screen.
3. Enable the respective check boxes.
4. When selected, press the **Enter** button to accept.

Figure 33

Units Screen

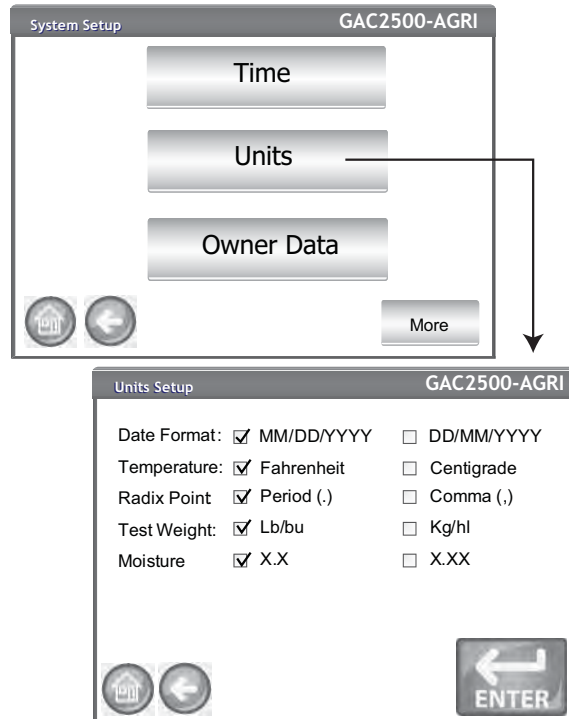



OWNER DATA

Enter name, address, and phone information, if desired. Data entered at this screen can be used as the header/footer on a print ticket.

This data can also be viewed by pressing the **Instrument Information** button found on the Main Menu screen, refer to Printer Setup.

1. At the System Setup screen, press the **More** button until the **Owner Data** button appears.
2. Press the **Owner Data** button and enter name, address, phone number by pressing the keypad icon.
3. Press the **Enter** button when finished.



NOTE: An external keyboard, barcode scanner, or mouse can be used to enter data.

Figure 34
Owner Data Screen

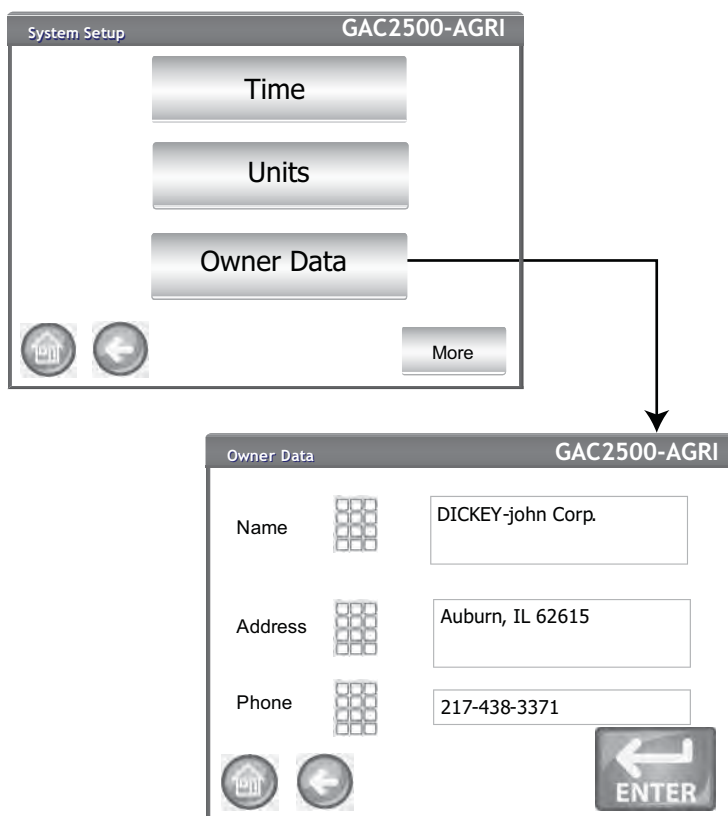



SERVICE DATA

The Service Data screen provides text entry fields for technicians to enter comments regarding service performed on the unit and service date.

- Resettable Counter resets the number of tests to 0.
- Total cycles indicates the number of tests performed over the life of the unit and is not resettable.

1. At the System Setup screen, press the **More** button until the **Service Data** button appears.
2. Press the **Service Data** button to display the Service Data screen.
3. Enter notes and date by pressing the keypad icon.
4. Press **Reset** button to set counter to 0, if desired.
5. Press the **Enter** button to accept changes.

NOTE: An external keyboard, barcode scanner, or mouse can be used to enter data.

Figure 35

Service Screen

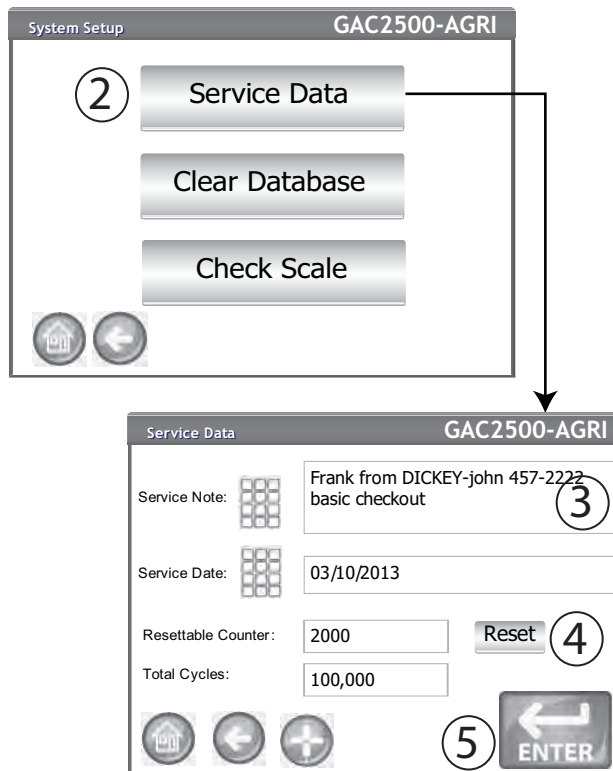



LCD DISPLAY TOUCH SCREEN CALIBRATION

The LCD display touch screen may not respond as it should with a finger touch or stylus after a period of time or if subjected to extreme temperature changes. The display can be re-calibrated to improve responsiveness.

1. At the Service Data screen, press the **Display Touch Screen Calibration** button and follow onscreen instructions.
2. Carefully press and hold finger on the center of the target.
3. Repeat as the target moves around the screen.
4. With a keyboard attached, press the **Enter** button to accept new settings or the **Esc** button to keep previous settings. Without an attached keyboard, press anywhere on the screen to accept.

Figure 36

Display Calibration

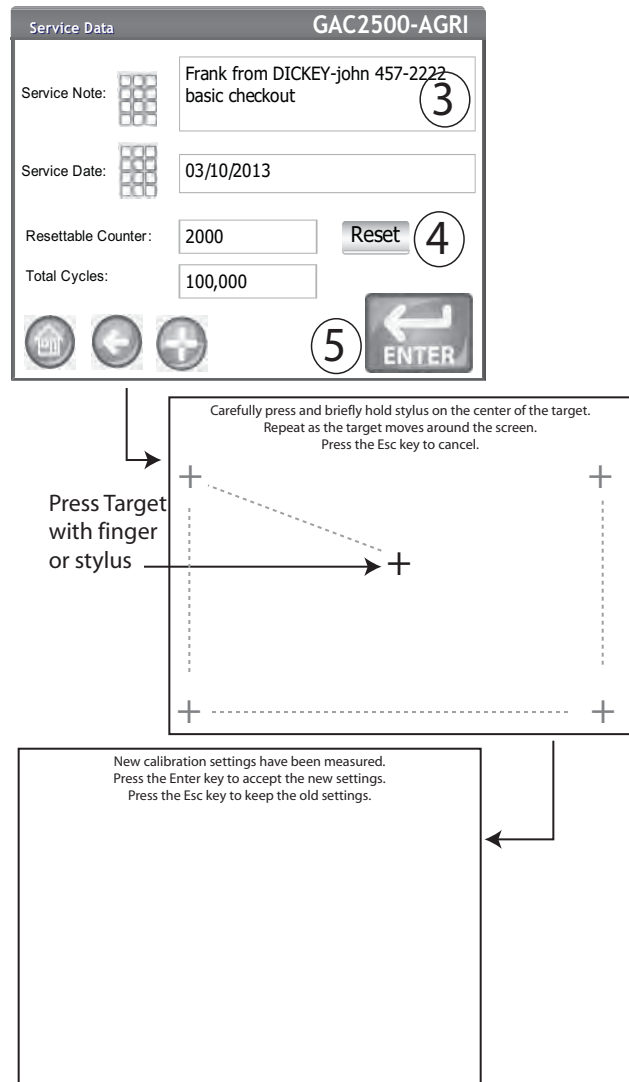



DATA STORAGE CAPACITY

The unit is capable of storing a maximum of 3,000 test results. The database can be cleared at any time by selecting the **Clear Database** button located under the System Setup screen. When stored data has reached approximately 2,500 records, a warning screen automatically appears when attempting a grain measurement that indicates memory capacity is getting low. Analysis can still occur until the maximum allowed records of approximately 3000 is reached. Once maximum storage is reached, grain analysis cannot continue until cleared.

NOTE: Records cannot be exported to a USB memory device at this screen. If a backup is required, this can be accomplished at the View Results screen found under the Results button.

To Delete Records:

1. At the System Setup screen, press the **More** button until the **Clear Database** button displays.
2. Press the **Clear Database** button to display the Delete Results screen.
3. At the Delete Results screen, press the **Delete All Results** button.
 - A Delete Engineering Data button appears if Engineering log files are present. This button must be pressed to clear those records.
4. Press **Yes** to proceed with clearing records.
 - Press **No** to abort record deletion.

*Figure 37
Memory Capacity Low Screen*

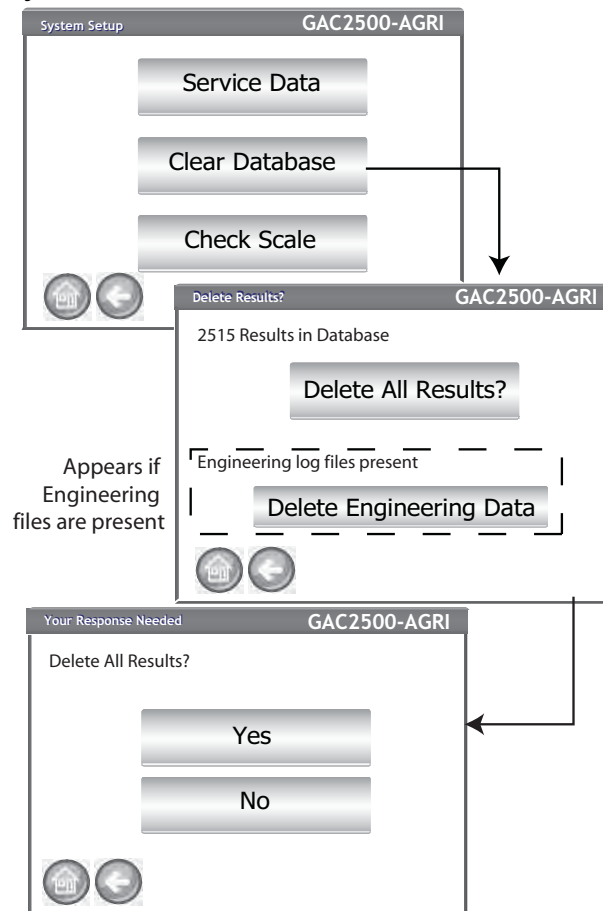



CHECK SCALE

Check Scale performs an instrument scale measurement for a weight accuracy comparison with an external scale. The readings displayed onscreen are actual temperature and weight product results.

To perform a Check Scale:

1. At the System Setup screen, press the **More** button until the **Check Scale** button displays.
2. Press the **Check Scale** button to display the Check Scale screen.
3. Fill hopper with a sample. When the hopper is full, the next screen automatically displays.

Figure 38

Performing a Check Scale

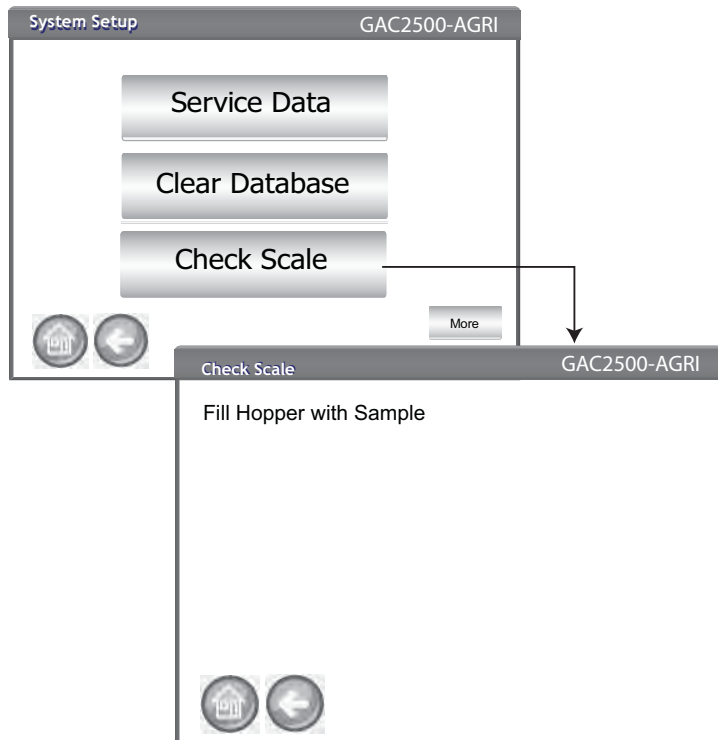

4. Press the **Measure** button to start the process.
 - This is the last screen that allows returning to the previous screen or returning to the Home screen.
5. Measurement process automatically begins measuring tare then loading and weighing the sample.
6. At the Scale Measurement Results screen, dump any excess material that fell into the drawer during the strike off process. The sample weight and temperature captured during the measurement appears on this screen.
7. Insert drawer into instrument.



Figure 39
Performing a Check Scale

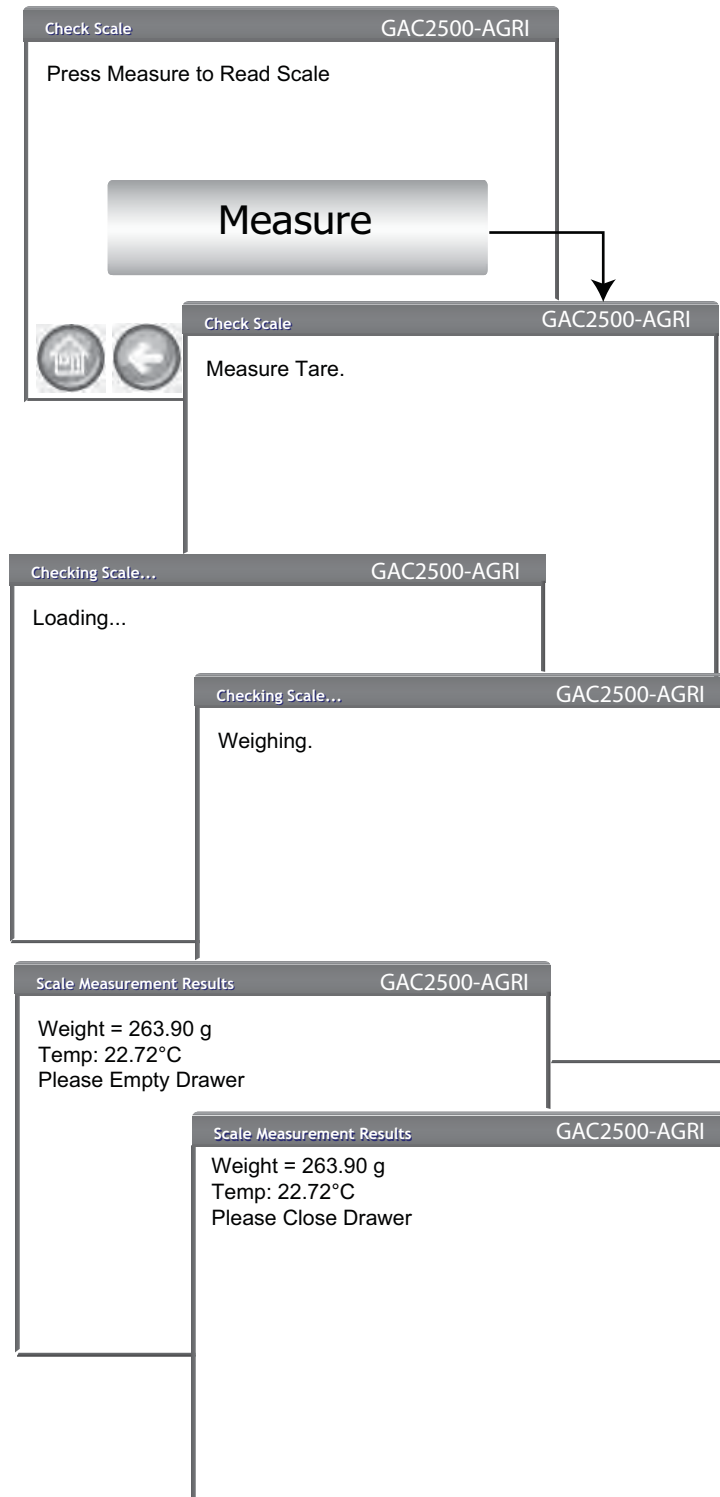

8. Press the **Dump Sample** button to dump sample into drawer.



9. Remove drawer and weigh the grain in the drawer on an external scale and compare to reading on the display.
10. Press the **Retest** button to perform another check scale or **Exit** button to return to the Setup screen.

Figure 40

Dumping Sample

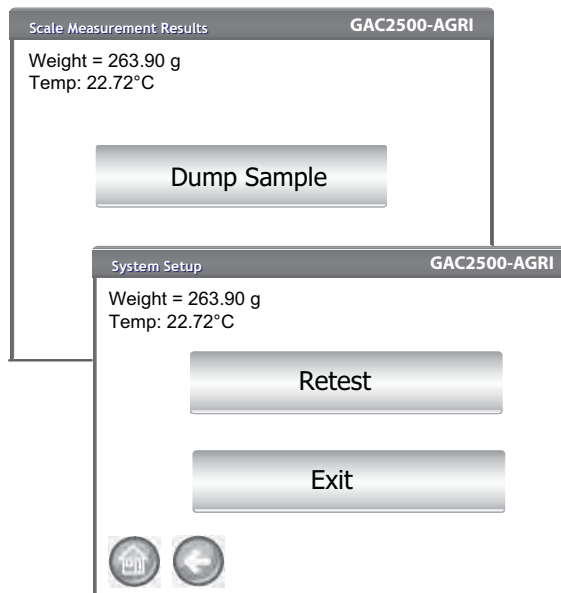



NETWORK SETUP

Network setup specifies ethernet settings for the instrument. This feature should be enabled by an authorized service technician or by contacting DICKEY-john Tech Support.

UPDATE INSTRUMENT

Update Instrument allows a software update to the instrument via a USB memory device. This feature should be enabled by an authorized service technician or by contacting DICKEY-john Tech Support.

Figure 41

Network Setup

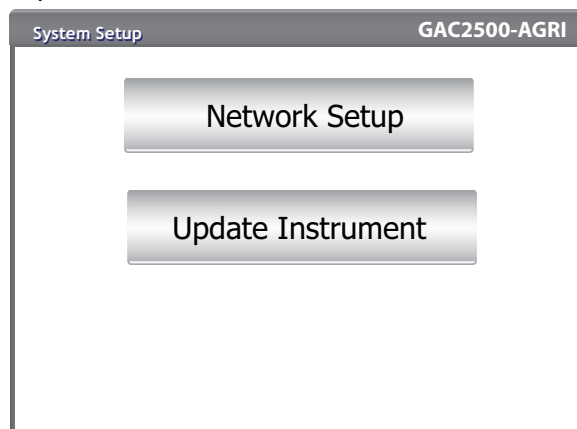



STARTUP

The GAC[®] 2500-AGRI is powered on by pressing the on/off switch located on the front panel (Figure 1). A series of Startup screens load after the system is turned on. A status bar indicates self checks are occurring and upon completion, the Instrument Information screen displays before the Main Menu screen appears.

IMPORTANT: On initial power up of the unit, the system defaults with open access to all screens. To ensure that the unit's settings are protected and accessible by qualified users, an administrative level with password should be created. Refer to the System Setup section for further information.

Figure 42
Startup Screens

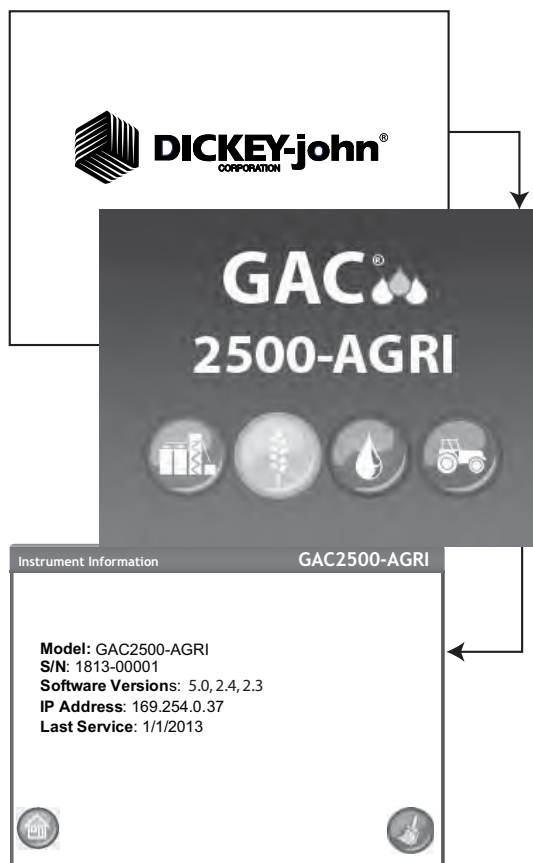



POWER DOWN

The unit can be powered down from any screen by pressing the on/off switch located on the front panel.

A virtual **Power Down** button is also available on some top level screens and powers off the unit in the same manner as the on/off switch.

A Power Down screen must be acknowledged before the unit shuts down.

Figure 43

Power Down Screen

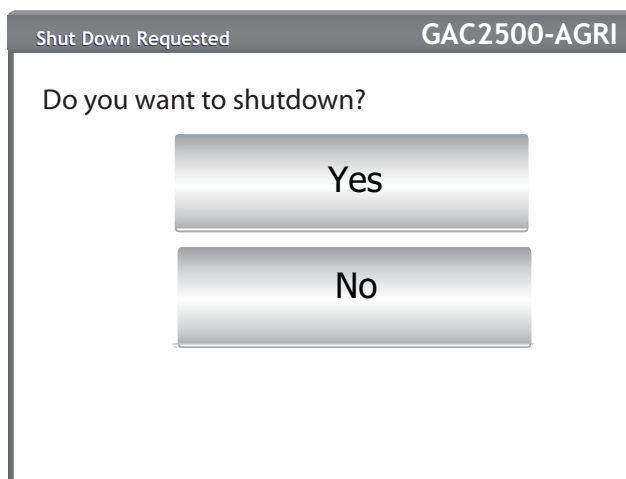



ANALYZING GRAIN

The Main Menu screen appears after all Startup screens have loaded. This is the "Home" menu through which all other menus are accessed.

At the Main Menu screen, three functions are performed:

1. To analyze grain
2. To access test results
3. To setup/customize the unit

Figure 44

Main Menu (Home) Screen

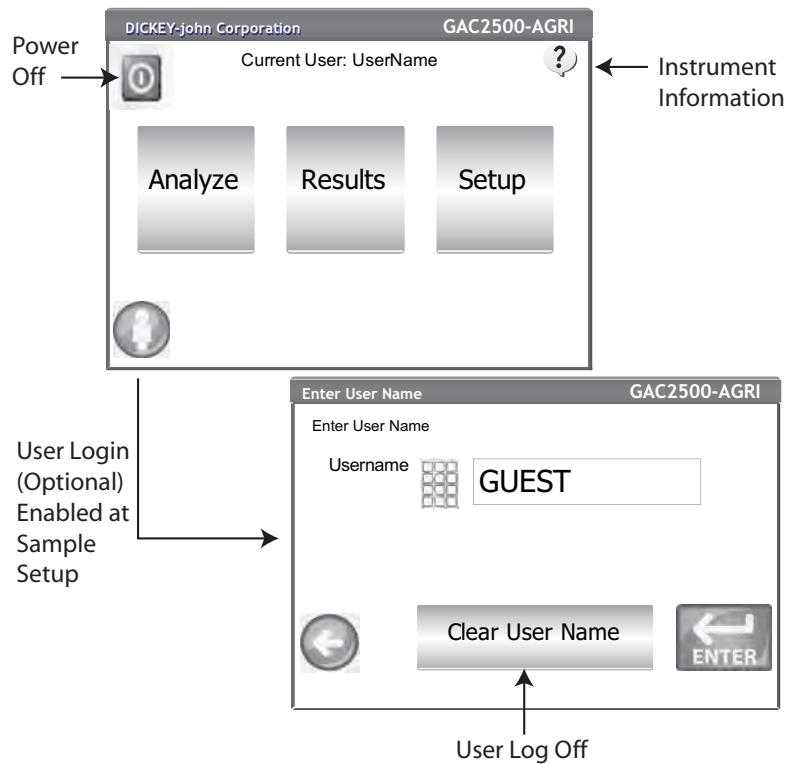

USER LOGIN (OPTIONAL)



A User Login is an optional feature that requires a user to login before grain can be analyzed. The unit default is no user login required. If a user login is required, a **User** button appears on the Main Menu screen. The User cannot proceed to test grain until a login name is entered. The User Login feature records the user name with a grain test in the unit database and prints on each grain ticket.



NOTE: Refer to the System Setup, Sample Setup section to enable user login.

USER LOGIN

1. At the Main Menu screen, press the **User** button.
2. GUEST appears as the default User Name and must be replaced with a different user name. Press the keypad icon to enter a new user name.

Figure 45

User Login Keypad



3. Press the **Enter** button to accept. The user name will appear as the current user on the Main Menu screen.

The unit will continue to analyze grain with the active user name until the user logs off or the power is turned off.

USER LOG OFF

1. At the Main Menu screen, press the **User** button.
2. At the User Login screen, press the **Clear User Name** button. GUEST will default as the new user name.
3. Press the **Enter** button to return to the Main Menu screen.
4. A new user name must be entered before additional grain analysis is allowed.



SELECTING PRODUCT

NOTE: If User ID is enabled, it must be entered before analyzation can occur.

To select a grain for testing:

1. At the Main Menu screen, press the **Analyze** button.
2. A pre-defined list of 4 grains appear on the Select Product screen.
 - Grains are saved in a “last used” order.
 - A grain selected on the first Select Product screen proceeds to Sample ID screen or the Analysis screen.
3. To view additional grains not viewable on the top level Select Product screen, press the **More** button.
 - Press the **Up** and **Down** buttons to view grains.
 - Select the desired grain in the product table.
 - Once selected, press the **Initiate** button to accept.
4. Grain is ready for analysis.

Figure 46

Select Product

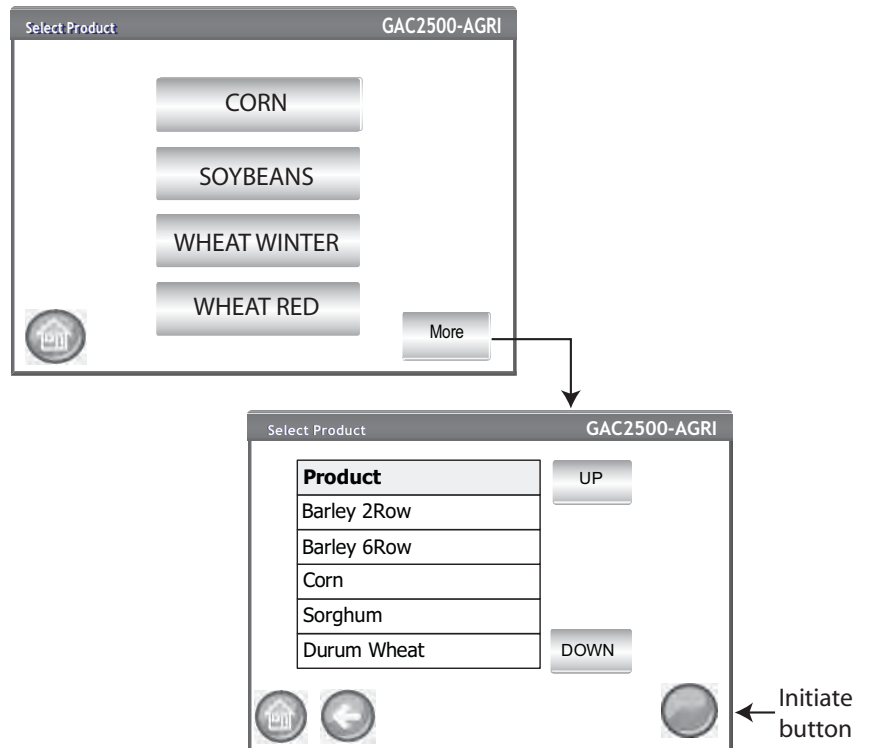

PERFORMING A GRAIN ANALYSIS

Screens that display during analysis will vary based on what configurations are enabled or disabled at the System Setup/Sample Setup screens:

- Automatic grain measurement when hopper is full
- Sample ID and/or Customer ID screen prompt step
- User Login requirement
- Empty drawer requirement after each test



NOTE: To eliminate this screen before each analysis, disable at the Sample Setup screen.

To begin analysis:

1. If enabled, the Enter Sample ID screen appears. The selected product and Issue ID displays at the top of the screen.
 - **Dump** button dumps product from the hopper.
2. A Sample ID name can be entered by pressing the keypad located next to the input box.
 - If automatic number sequencing is enabled, the next higher number is automatically entered with additional tests of the same grain (1,2,3, etc). If auto sequence is not selected, the previous tests sample ID is cleared.
3. A Customer ID can be entered by pressing the keypad located next to the input box.
4. Press the **Initiate** button to proceed.
5. Pour grain into the hopper heaping grain slightly up to the hopper full sensors.

Figure 47

Sample ID Screen

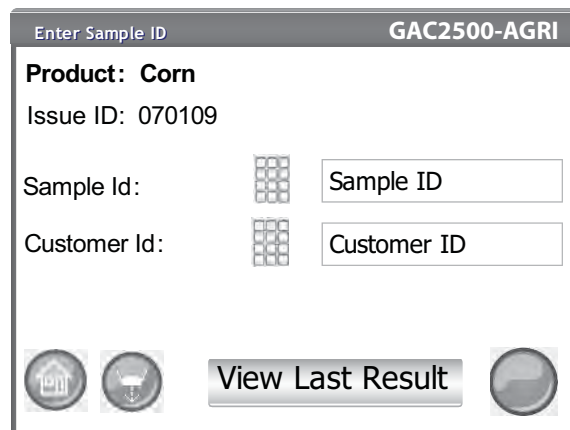

CAUTION

Do not insert fingers or foreign objects into the opened hopper doors.

HOPPER LEVEL INDICATOR

During analysis, hopper level status is indicated via the **Initiate** button.

- Yellow indicates hopper is empty and must be filled before proceeding.
- Green indicates hopper is full and testing can proceed.



Figure 48

Hopper Level Indicator

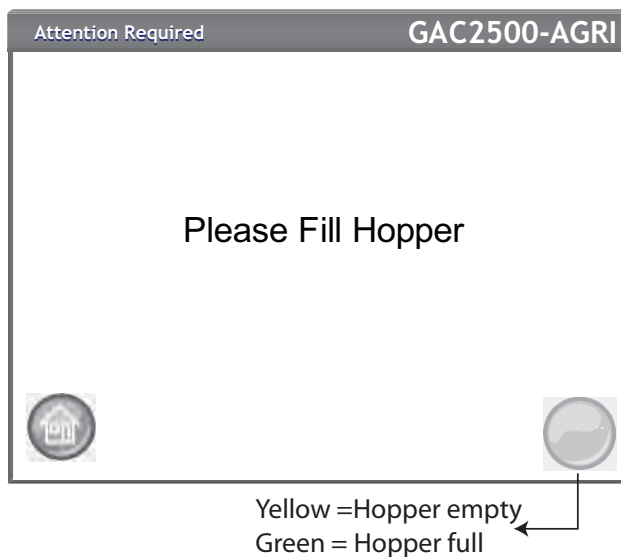

6. Press the **Initiate** button (green) to begin test. Grain will dump into the measurement cell from the hopper. A test will only perform when the **Initiate** button is green.
7. The cell fills and the striker arm swings across the top of the test cell to wipe away excess grain.
8. During analysis, a testing status bar indicates progress.

Figure 49

Analysis Process

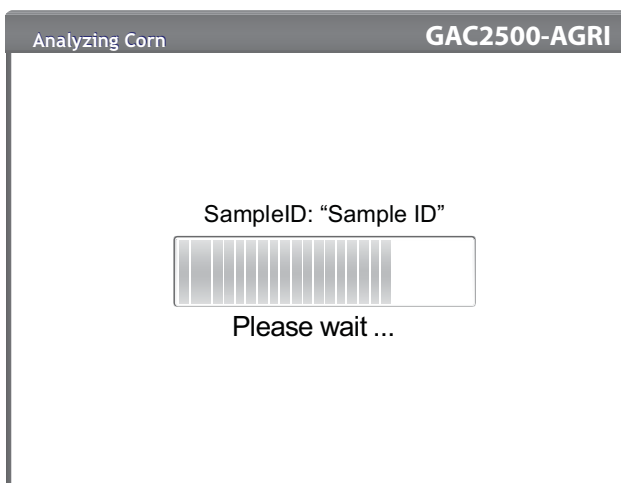

9. An audible alarm indicates when test is complete and automatically advances to the Analysis Results screen.



NOTE: To automatically return to the Sample ID screen without pressing the **Initiate** button refer to the System Setup, Results Setting section for enabling Automatic Return.

10. The Analysis Results screen displays:
 - Product tested
 - Sample name
 - Moisture content %
 - Test Weight lbs/bu or kg/hl (optional)
 - Temperature (optional)
11. Test results are automatically saved to the unit.
12. Press the **Initiate** button to perform another test.

Grain automatically dumps into the drawer for removal in Manual or Automatic advance.

- A requirement that grain be dumped after each test can be enabled at the Result Setup screen.

Drawer capacity holds approximately 3 tests. After 3 tests the drawer must be emptied before proceeding.

IMPORTANT: When using a bottomless grain drawer with flow-through counter, the bottomless drawer feature should be enabled under System Setup, Result Settings to perform unlimited grain tests to eliminate error messages.

Grain will not dump out of the cell if drawer is not present or secure.

Figure 50

Analysis Screen

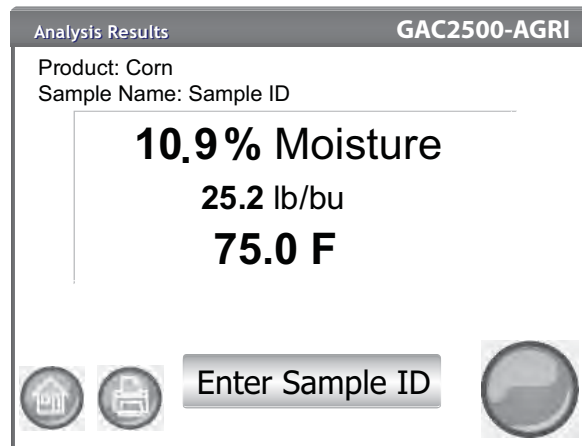

Other Actions:

- **Print** button sends test results to a local printer.
- **Home** button returns to the Main Menu screen.
- **Enter Sample ID** button to enter a Sample ID for next analysis. Does not allow changing the current Sample ID.





GENERAL CLEANING TIP

Some material accumulation around the measuring cell can possibly occur over time and could possibly affect measurement results.

It is recommended the unit be regularly cleaned to ensure continued and consistent results. Refer to the Maintenance section for cleaning steps.

NOTE: Refer to the Error Message section for probable causes and corrective actions if errors occur during analysis.

NOTE: Refer to the Save Results section and Printing Options section for output options.



DATABASE MEMORY MESSAGES

DATABASE MEMORY FULL WARNING

When stored data has reached approximately 2,500 records, a warning screen automatically appears when performing a grain analysis indicating memory capacity is getting low. Analysis can still occur until the maximum allowed records of approximately 3000 is reached.

NOTE: Records cannot be exported to a USB memory device at this screen. If a backup is required, this can be accomplished at the View Results screen found under the Results button.

To clear Database Records:

1. At the Memory Low screen, press **Yes** to delete results.
 - Select **No** to return to previous screen and abort deleting records.
2. At the Delete Results screen, the number of records in the database is indicated. Press the **Delete All Results** button to confirm record deletion.
3. Press the **Yes** button to verify and begin deleting records.
 - Select **No** to return to previous screen and abort record deletion.

Figure 51

Clear Database Screen

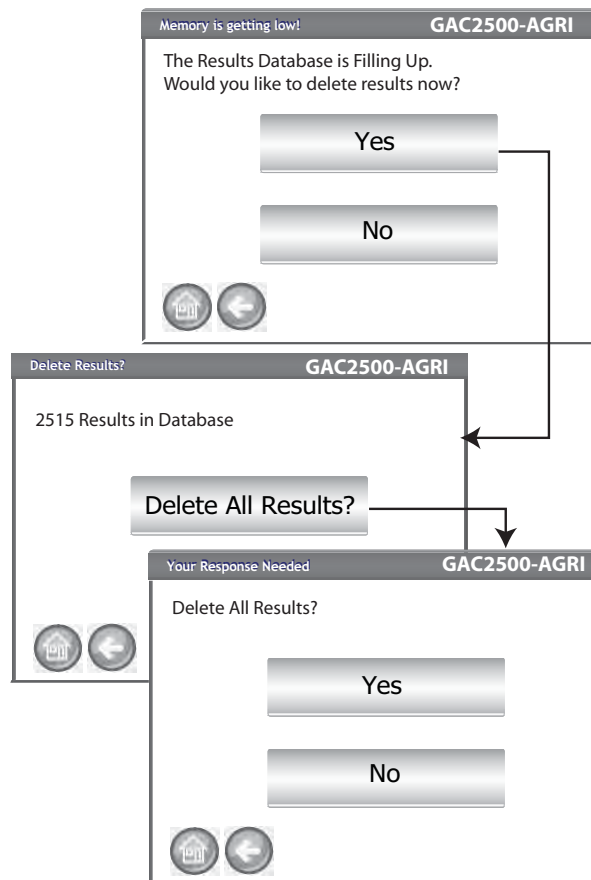



OUT OF MEMORY

A Database Full screen displays when performing a grain analysis and the database has reached maximum storage capacity. Analysis cannot continue until records are deleted. Follow onscreen instructions to remove records.

Figure 52

Out of Memory

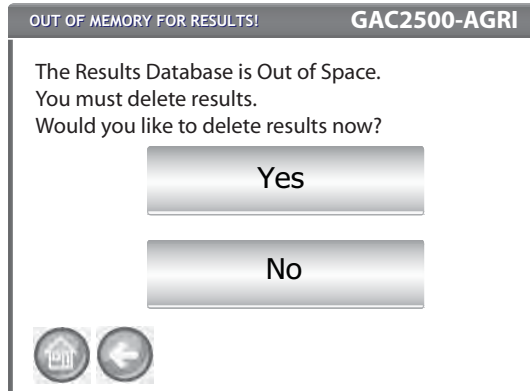

DATA DRIVE MEMORY LOW

GAC 2500-AGRI instruments automatically have engineering data enabled. Engineering data is stored separate from the Results Database. Therefore the Results database can be empty but the Data Drive can exceed capacity causing a memory low error. Analysis can continue but the data drive should be cleared soon.

Figure 53

Data Drive Memory Low Warning

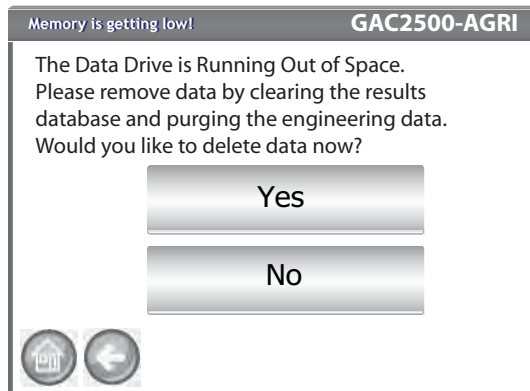



DATA DRIVE OUT OF MEMORY

A Data Drive Out of Memory screen appears when the data drive is out of space. An analysis cannot be performed until data is cleared.

Figure 54

Data Drive Out of Memory Warning

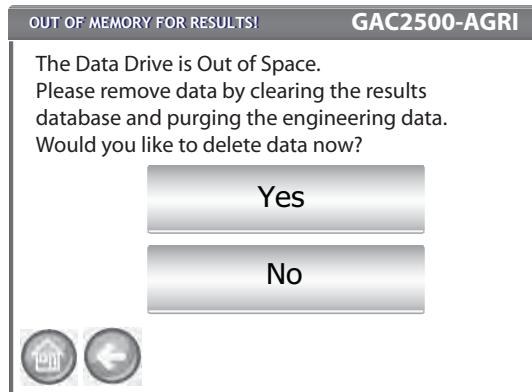



RESULTS

The Results screen provides access to grain test results and product list.

To View Test Results:

1. At the Main Menu screen, press the **Results** button.
2. At the Results screen, press the **View Results** button.

NOTE: A momentary pause can occur before test results appear on screen. Do not press any buttons during this time.

Figure 55

View Results

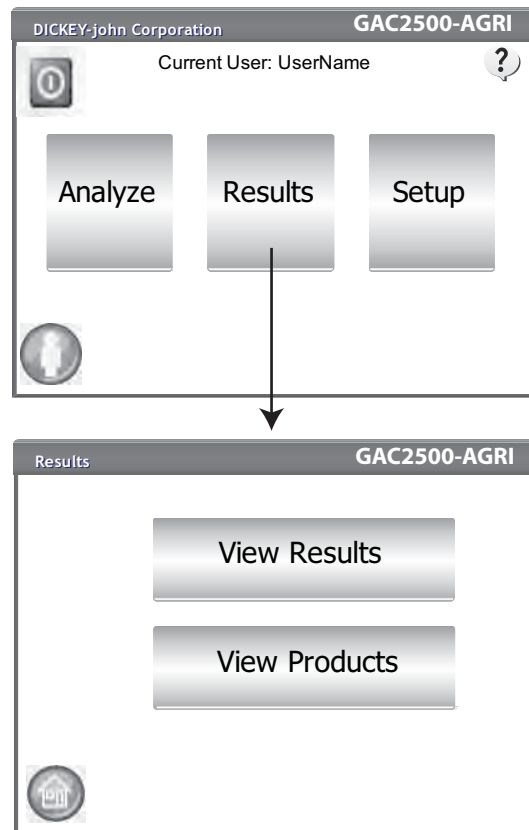

3. The Results screen default displays all test results with Sample ID, % Moisture, Weight, Temperature, Product, Issue No., Customer ID, User ID, Date and Time.
4. Press the **Filter** button to choose what events display on the test results record. Refer to Refine Query Options for criteria options.
5. Press the **Print** button to print results as displayed in the table on the Results screen.
6. Insert USB memory device and press the **USB** button to transfer product results to a computer. All results are transferred to USB regardless of Filter setting.



REFINE QUERY OPTIONS

Figure 56

Product Like Criteria Example

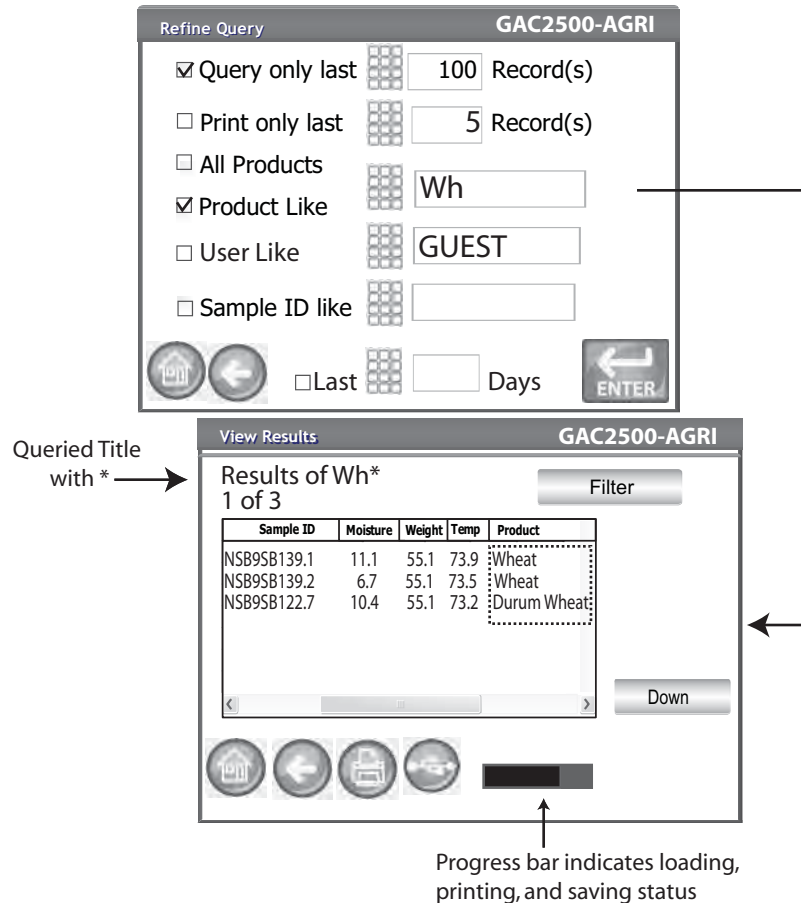

Results can be filtered to display based on one or all of the following criteria:

QUERY ONLY LAST NUMBER OF RECORDS

Allows entry of a specified number of records to query so that only a specific last number of records are returned. When the Query Only Last option is checked, the title of what is queried will contain an asterisk to indicate that all returned results are displayed per the limit of records entered but there could be more older records in the database that meet the same criteria.

PRINT ONLY LAST NUMBER OF RECORDS

Allows entry of a specified number of records to print starting with the last sample taken, such as printing the last 5 samples taken.



NOTE: A status bar indicates progress of retrieving filtered data. Results can take several minutes to load while retrieving data. Do not press any buttons during this time.

NOTE: User Like and Sample ID Like filter function works the same as the Product Like filter. Refer to (Figure 56)

ALL PRODUCTS

Displays all sample tests stored on instrument.

PRODUCT LIKE

Allows entry of part or all of the product name to perform a product search. All records that fit criteria entered in the Product Like filter search will display. Example: Searching for a product like "Wh" searches for all records with "Wh" in the product name. (Figure 56) displays results for Wheat and Durum Wheat.

USER LIKE

Allows entry of part or all of the User name to perform a search for similar records within the User field. All records that fit the criteria entered in the User Like filter search will display.

SAMPLE ID LIKE

Allows entry of part or all of the Sample ID name to perform a search for similar records within Sample ID. All records that fit the criteria entered in the Sample ID Like filter search will display.

UNABLE TO SHOW QUERY RESULTS

When the system has reached near memory storage capacity, a query might not be able to display results per the number of records entered on the Query screen. In this instance, a screen confirmation will require the query be performed at a reduced number than was entered on the Query screen.

- Press **OK** to run query at reduced number
- Press **Abort** to cancel and return to Home screen.

Figure 57

Unable to Show Results Screen

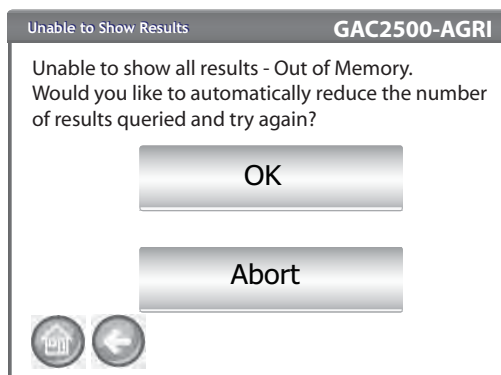



VIEW PRODUCTS

The Installed Products screen provides an alphabetical table of active products stored on the unit with respective Issue ID. Products can only be viewed and printed at this screen.

1. At the Results screen, press the **View Products** button.
2. Press the **Print** button to print all active products and respective Issue ID's.



Figure 58

View Products Screen

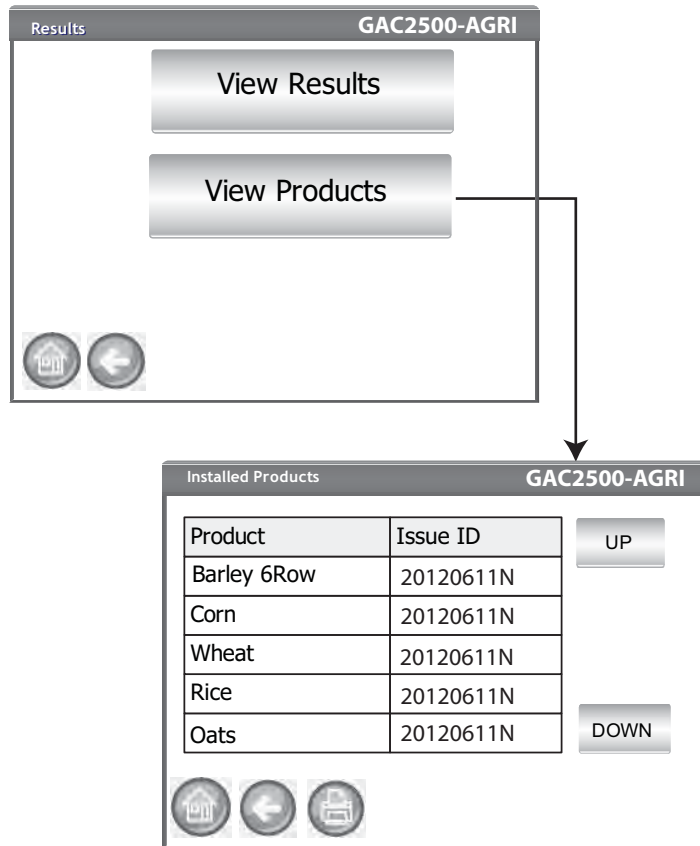



GRAIN CALIBRATIONS

Grain calibration files will be available for download at the DICKEY-john website (www.dickey-john.com) for transfer to the GAC[®] 2500-AGRI via a USB memory device.

These files are also available through DICKEY-john Technical Support Group at 1-800-637-3302.





DIAGNOSTICS

The Diagnostics screen is used by trained service technicians for troubleshooting. It is recommended that the functions on this screen are only performed by a DICKEY-john representative.

To view Diagnostics screen:

1. Press the **Setup** button to display the Setup screen.
2. Press the **Diagnostics** button to view the Diagnostics screen.

Figure 59

Diagnostics Screen

GAC2500 Diagnostic Form - AGRI-00001
GAC2500

Weight: -00.06
IR Temp: 21.76
MAC:00-30-20-ff-09-80 IP:127.0.0.1

Open Hopper Door
Rehome
IR?

Load Grain and Strikeoff

Measure Load Cell
Cal1
Cal2
E

Dump Grain
Advance Striker

DDS Freq: 149000000 Hz Update

Termination
 Gain Setting: 7

50 Relay
 Z?

VARC Relay
 DFT?

Cell Relay
 DFT_STATE_DONE

Fin 149000000 Hz

Np 100000

LP Model
 Z = 47.7605710572315-4.8597597256481Si

Use Averaged
 Zm = 48.007

Show Raw Z*
 P = 2.101040339

Comm Check
File I/O

HOPPER_LEVEL_FULLL
 FILL_STATE_HOME
 CELL_STATE_UNKNOWN
 DUMP_CLOSED
 DRAWER_STATE_CLOSED
 REMOTE_MODE_OFF
 Stored E: 10563980, (0 g) 10563997, (300 g) 11265304
 Norms: TW (1.0000x+0.0000) Perm (1.0000x+0.0000) Temp: 0.00
 Ambient Temp: 23.62
 Line: 15.3V
 Motor: 15.3V
 Cell: 6.5V
 5V: 5.1V
 Batt 3V: 3.1V

DICKEY-john, GAC2500 CELL BOARD, 2.2, 2511006
 DICKEY-john, GAC2500 GRAIN HANDLER, 2.4
 App Version = 4.2.0.0





MAINTENANCE

IMPORTANT: It is highly recommended the unit be regularly inspected and cleaned to ensure continued and consistent results.

For optimum performance, extensive cleaning should be performed weekly or more often based on surrounding environmental conditions. Factors such as dust, temperature extremes, grain dust, and external humidity vary from location to location. If there are any questions about the cleanliness or instrument performance, contact your local authorized service center.

Note: The following recommendations are provided as a guideline to maintain a robust and quality operating instrument. It should not be interpreted as an exhaustive maintenance program. Dust and debris may periodically accumulate in areas not specified in this manual. The owner is responsible for ensuring overall equipment cleanliness. If any questions arise regarding the maintenance or performance of the instrument, contact your dealer or local authorized service center.

EXTERNAL CLEANING

The LCD display may require periodic cleaning. Use a commercial cleaner for glass lenses to remove dust.

CAUTION

Do not apply water, organic solvent or chemicals, such as acid and alkali to the LCD display.

The GAC[®] 2500 surface can be cleaned with any cleaner designed for plastic and stainless steel surfaces.

Periodically use a rag to wipe the grain hopper and the (2) upper grain hopper sensors.

Figure 60

Grain Hopper Sensors

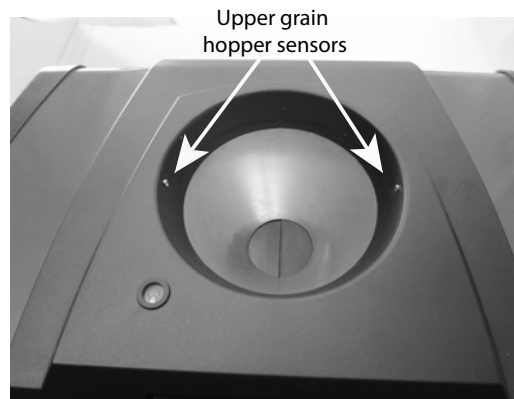



INTERNAL CLEANING

Performing continuous tests can result in material accumulation around the critical internal components and adversely affect the measurement.

Two types of cleaning are recommended on an as needed basis:

- Daily clean
- Extensive clean

DAILY CLEAN METHOD

A daily clean method allows cleaning the cell and door using an automated process. During the cleaning sequence, the hopper door automatically opens. Instruments with version 2.4 grain handler firmware, the trap door opens automatically also.

To start the cleaning process:

1. At the Main Menu screen, press the **Instrument Information** button.
2. At the Instrument Information screen, press the **Clean** button.
 - Pressing the **Clean** button automatically begins the cleaning sequence and opens the hopper door and the trap door (version 2.4 grain handler firmware).

Figure 61

Daily Clean Method

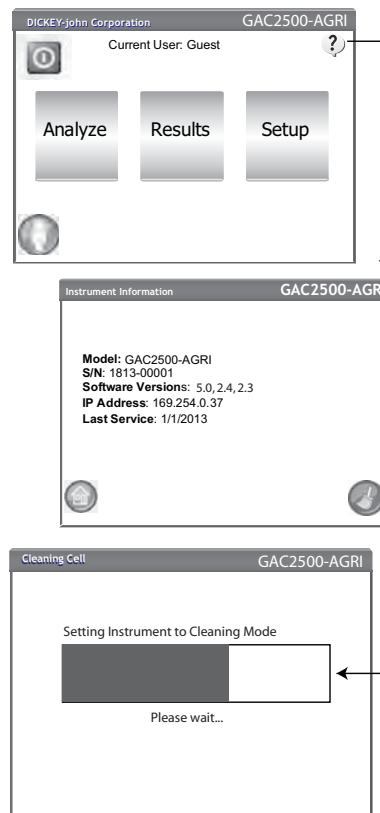

3. Remove the grain drawer.



Figure 62

Remove Grain Drawer



4. Using the supplied brush, manually remove any loose or stuck grain or dust from the measuring cell.
5. Press the **OK** button to return instrument to normal operation.

CAUTION

Hands should be clear from inside the instrument before pressing the OK button.

Figure 63

Cleaning Sequence

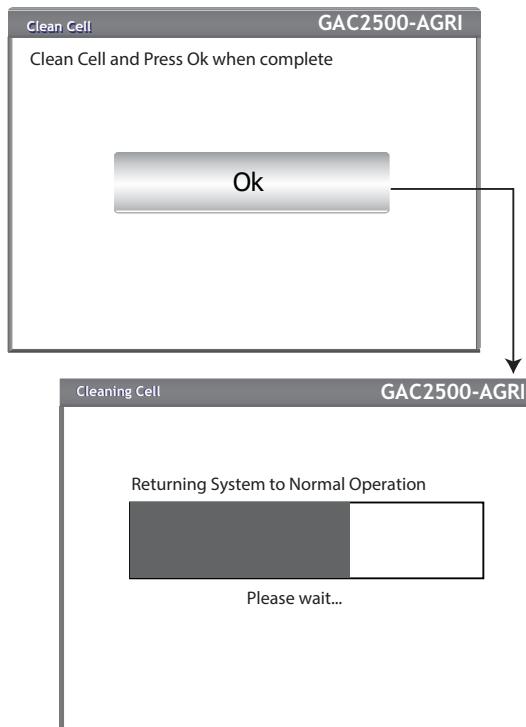

6. Insert grain drawer.



NOTE: For customers that require a more extensive cleaning procedure with buildup in the cell, contact and schedule your instrument for cleaning with your dealer or authorized service center.

EXTENSIVE CLEANING METHOD

The daily cleaning method should be performed first before proceeding to the extensive cleaning method.

IMPORTANT:

Extensive cleaning should be performed weekly or more often based on surrounding environment conditions. Factors such as dust, temperature extremes, grain dust, and external humidity vary from location to location. If there are any questions about the cleanliness or instrument performance, contact your local authorized service center.

Tools required for internal mechanism cleaning:

- Brush p/n 206410003 (included with instrument)

Extensive cleaning of the instrument involves two steps to ensure optimum instrument performance:

1. Internal mechanism cleaning
2. Temperature sensor probe cleaning

To Clean the Instrument:

1. Power down the instrument.

Figure 64

Power Down Instrument



2. Unplug power cord.

Figure 65

Unplug Power Cord

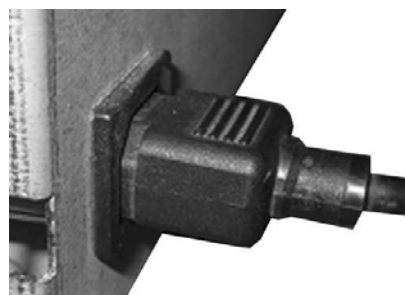



3. Remove other accessory cords (USB and printer).

Figure 66

Remove Accessory Cords



4. Remove grain drawer.

Figure 67

Remove Grain Drawer



5. Place the unit on its back side.

Figure 68

Place Unit on Back Side





6. Manually pull down on trap door.

Figure 69

Pull Down on Trap Door

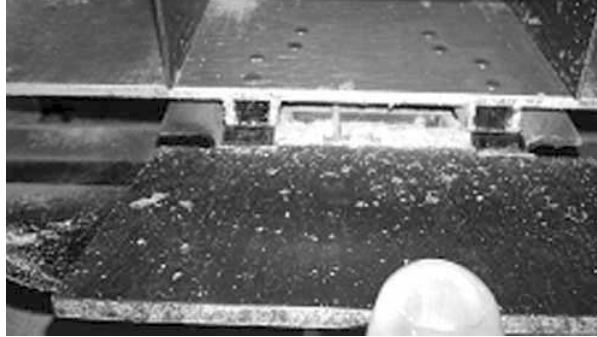

7. Clean surfaces around measurement cell including hinge, trap door, and edge of cell with the supplied brush.

Figure 70

Clean Surface Area Around Cell, Hinge, Trap Door, Edge of Cell

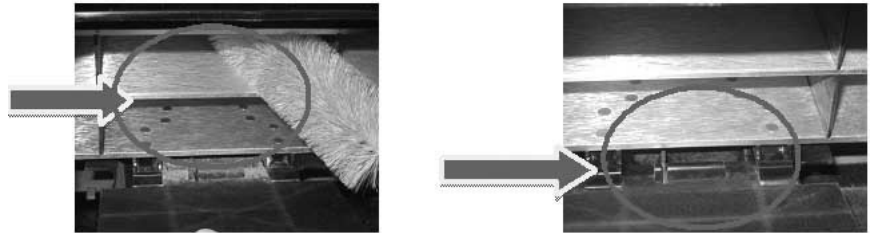

8. Close the trap door and clean hinge under trap door with brush.

Figure 71

Clean Under Trap Door



9. Proceed to instruction for cleaning the temperature sensor probe.



CLEANING THE TEMPERATURE SENSOR PROBE

IMPORTANT: Any particles in front of the sensor's optics can affect measurement performance. Therefore it is crucial to sufficiently clean the sensor. For excessive dust and/or foreign material buildup on or around the temperature sensor, it is recommended the instrument be returned to **DICKEY-john Service** or authorized service center.

The temperature sensor may require cleaning due to dust buildup and/or foreign material that has collected around the sensor that could potentially cause temperature error readings during analysis. It is important the temperature sensor is visually inspected and cleaned each time a regular maintenance check of the instrument is conducted.

Tools required for cleaning the temperature sensor probe:

1. One of the below cotton swabs:
 - Standard 6" long cotton swab (i.e. McMaster-Carr p/n 7074T12) for flush sensor
 - 6" long, tapered tip cotton swab (i.e. McMaster-Carr p/n 71035T54) for embedded sensor

Figure 72

Recommended Cotton Swab for Flush Sensor



Figure 73

Recommended Cotton Swab for Embedded Sensor

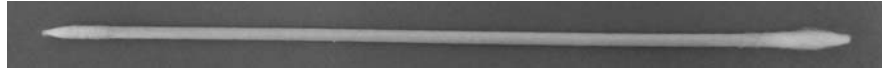

2. 99% Isopropyl Alcohol

Figure 74

99% Isopropyl Alcohol



3. 10" flat head screw driver (only for instruments with flush sensor/brush bracket).

Figure 75

10" Flat Head Screw Driver





TEMPERATURE SENSOR TYPE

The GAC 2500 is equipped with one of two different sensor types. The cleaning method is similar for both types however the cotton swab for cleaning varies based on the sensor type.

- older instruments may include an embedded sensor on the circuit board (recommended cotton swab McMaster-Carr p/n 71035T54)
- newer instruments include a flush sensor on the circuit board and a brush bracket (recommended cotton swab McMaster-Carr p/n 7074T12)

TEMPERATURE SENSOR LOCATION

With the instrument placed upside down and looking inside the instrument, the sensor probe is located in the middle of the instrument toward the top and front attached to a circuit board.

Figure 76

Sensor Probe Location

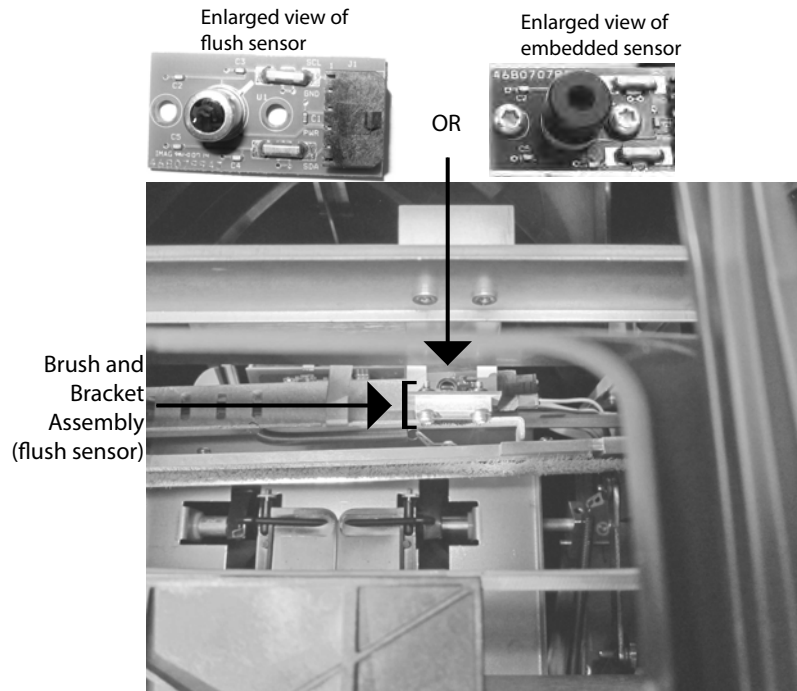



To Clean the IR Temperature Sensor:

1. Gently place instrument upside down.

Figure 77

Place Instrument Upside Down



2. Visually inspect the IR temperature sensor to determine the type of sensor installed.
3. For instruments with the flush sensor and brush bracket, the following procedure can be utilized to remove particles from the brush. Carefully place the head of the screw driver (10" length recommended) at the bristles and use a sweeping side-to-side motion through the entire length of the bristles no fewer than three times.

Figure 78

Cleaning the Brush Assembly

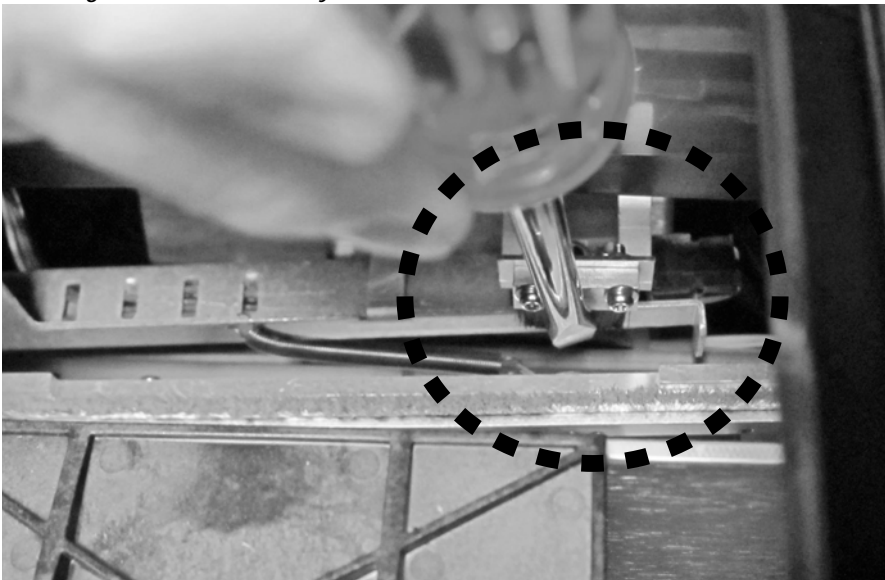

4. Select the appropriate cotton swab as described. Wet one end of the cotton swab with 99% Isopropyl alcohol.



Figure 79

Wet Swab with Alcohol



5. Swab method for cleaning sensor:

- For embedded sensors, the sensor is located inside the black tube. Insert the swab inside the black tube and gently clean the IR temperature sensor with the wet end of the cotton swab as depicted in (Figure 80).
- For flush sensors, gently clean the entire IR temperature sensor surface with the wet end of the cotton swab as depicted in (Figure 80).

Figure 80

Magnified View of Proper Cleaning with Cotton Swab

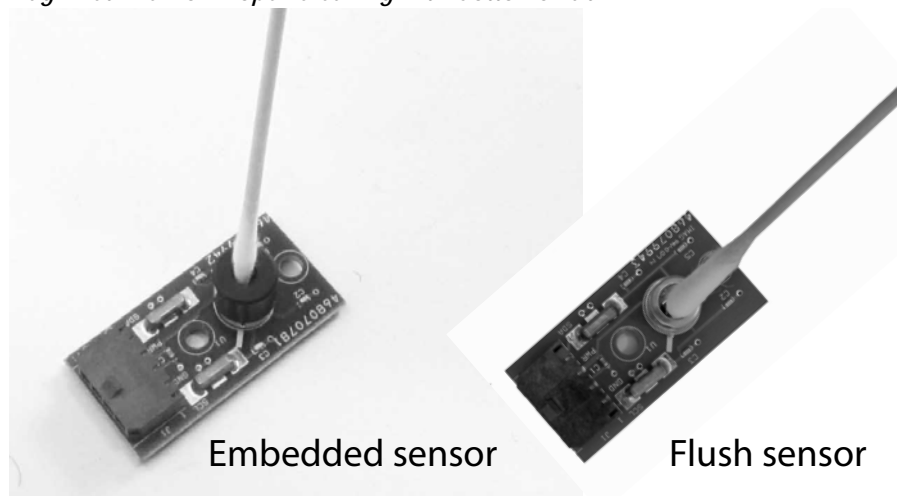



The IR temperature sensor can be cleaned with the Q-tip by placing the Q-tip through the funnel or on the outside of the funnel as depicted in (Figure 81).

Figure 81

Cleaning the Sensor with Cotton Swab

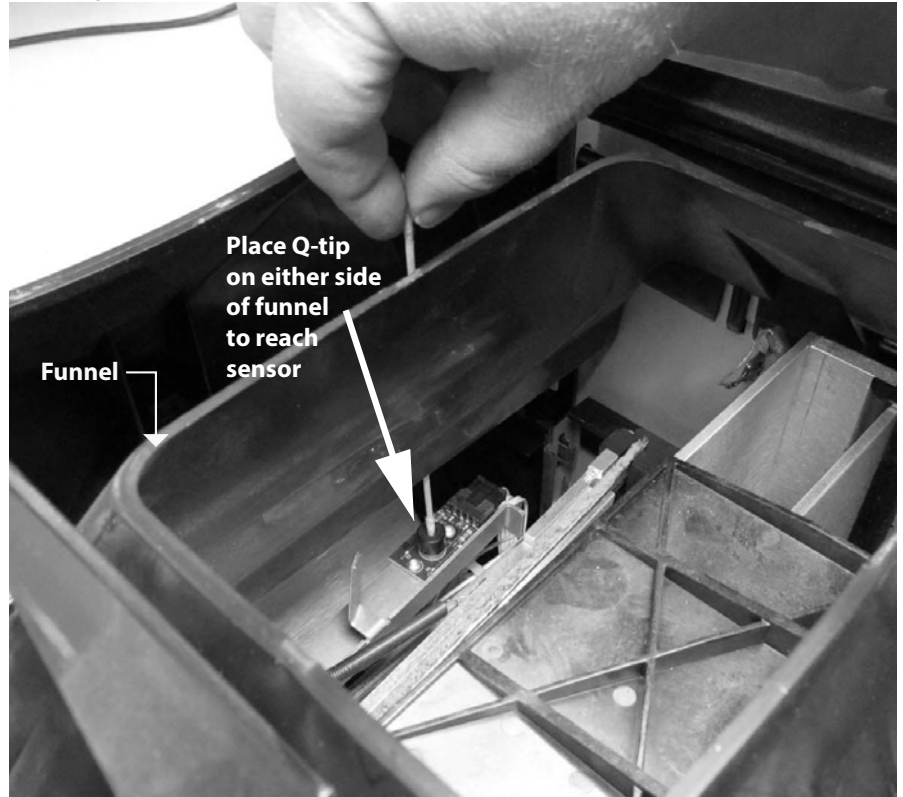

6. Allow the temperature sensor to dry for 90 seconds then gently clean with the dry end of the cotton swab.
7. Visually inspect the temperature sensor as well as all other areas cleaned to ensure the instrument is free from debris. If there is any question about the cleanliness of the instrument, it should be returned to a dealer or authorized service center.
8. If cleaning is acceptable, return instrument to upright position and replace the drawer.
9. Reconnect power cable and accessory cords.
10. Power on instrument.

IMPORTANT: The foregoing recommendations are provided as a guideline to maintain a robust and quality operating GAC 2500. It should not be interpreted as an exhaustive maintenance program. Dust and debris may periodically accumulate in areas not specified in this manual. The owner is responsible for ensuring overall equipment cleanliness. If any questions arise regarding the maintenance or performance of the instrument, contact your dealer or local authorized service center.





TROUBLESHOOTING

If the system locks, press and hold the **On/Off** button on the front of machine until system turns off or unplug instrument power. Wait a few seconds and then power on.

The GAC[®] 2500-AGRI contains a microprocessor to control grain sample measurements and self-checks that determine the integrity of the internal electronics. If any limit is exceeded or malfunctions occur an error code displays with a recommended resolution.

ERROR MESSAGES

Error messages display when an abnormal event occurs. An error can be acknowledged by pressing the **Initiate** button. For any failure that persists, contact DICKEY-john Technical Support at 1-800-637-3302.

Figure 82

Error Screen Example

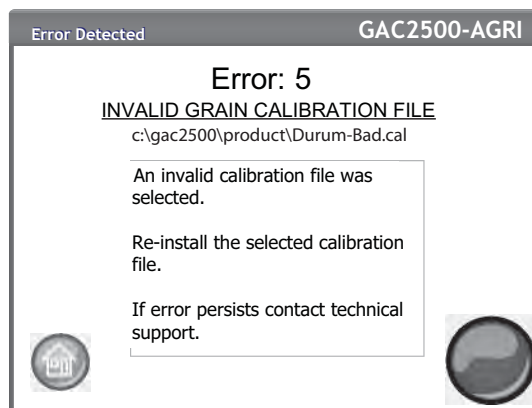



OPERATOR'S MANUAL



ERROR CODE	ERROR	PROBABLE CAUSE	CORRECTIVE ACTION
1	Empty Cell Measurement Out of Spec	Moisture or dirt buildup in cell.	Dump grain and verify cell is clean and free of grain in and surrounding the cell.
2	Empty Cell Weight Out of Spec	Empty cell measurement is out of tolerance	Dump grain and verify cell is clean and free of grain in and surrounding the cell.
3	No Products Installed	No product calibrations were found on the machine.	Install product calibration files.
4	Fill Motor Jammed	The motor has stalled while loading grain from a possible obstruction.	Clear blockage from cell.
5	Invalid Grain Calibration File	An invalid calibration file was selected.	Re-install the selected calibration file.
6	Moisture Too High	Measured product is above the moisture upper limit of the calibration.	Verify sample filled the cell.
7	Moisture Too Low	Measured product is below the moisture lower limit of the calibration.	Verify sample filled the cell.
8	Instrument Low Temp Limit Exceeded	Instrument temperature is less than the allowed limit of 0 degrees C.	Move unit to a warmer environment or allow to warm up.
9	Grain High Temp Limit Exceeded	Grain temperature has exceeded the unit specification to analyze grain.	Allow grain to cool and then re-analyze.
10	Grain Low Temp Limit Exceeded	Grain temperature has exceeded the unit specification to analyze grain.	Allow grain to warm and then re-analyze.
11	Sample Weight Too High	Test weight is greater than the range specified for the calibration selected.	Use a more representative sample and re-analyze grain. Verify correct grain calibration is selected.
12	Sample Weight Too Low	Test weight is lower than the range specified for the calibration selected.	Use a more representative sample and re-analyze grain. Verify correct grain calibration is selected.
13	No Communication	An internal communication failure has occurred and communication has been lost.	Power unit off and turn back on to reset.
14	Instrument High Temp Limit Exceeded	Instrument temperature is higher than the allowed limit of 45 degrees C.	Check unit ventilation or move to a cooler environment.
15	Unit to Grain Differential	The difference between grain temperature and machine temperature has exceeded the unit specification to analyze grain.	Allow grain and machine temperature to equalize and then re-analyze.
16	Internal Power Supply Out of Spec	Unit internal voltage is out of specification.	Service is required. Contact DICKEY-john Tech Support at 1-800-637-3302.
17	Unable to Predict Moisture	A corrupt instrument calibration file or other unexpected error.	Dump sample and re-analyze.
19	Instrument Needs Updated	Firmware in the instrument is out of date for this application.	Update device with new firmware.
21	File I/O Error	An unexpected file i/o error has occurred.	An obstruction has occurred in the cell. Blockage must be cleared before testing can resume.
22	RF interference detected. Unable to compute moisture	Outside 2-way radio interference or cell board communication interference	Remove outside radio interference. If problem persists, contact DICKEY-john Technical Support at 1-800-637-3302.
50	Weight Measurement Device Error	An error has occurred with the load cell.	Power unit off and turn back on to reset. Service unit if failure continues.
51	Invalid Password	A service function with an invalid password was attempted.	If service is required, contact DICKEY-john Technical Support at 1-800-637-3302 for assistance on how to obtain the password and proper service procedure.
52	Date/Time Incorrect	The programmed machine date is less than expected.	Program the instrument date and time. If problem persists, then the battery backup for the internal clock may need to be replaced. Contact DICKEY-john Technical Support at 1-800-637-3302 for service.
53	Cold Sample Moisture Too High	The sample is too high in moisture to accurately read at its current temperature.	Warm the sample above the low temperature threshold specified in the product calibration file and rerun the measurement.
55	Dump Motor Timeout	The dump mechanism does not appear to be closing.	Check that the dump motor optical sensor is clean and there is no interference in the dump mechanism. Press the Green button to retry. If error persists, contact technical support at 1-800-637-3302.

OPERATOR'S MANUAL



ERROR CODE	ERROR	PROBABLE CAUSE	CORRECTIVE ACTION
100	Unexpected Application Crash	The application has encountered an unexpected error.	Press the Initiate (green) button or cycle power to reboot the instrument. If problem persists, contact Dickey-john Tech Support at 1-800-637-3302.

Dealers have the responsibility of calling to the attention of their customers the following warranty prior to acceptance of an order from their customer for any DICKEY-john product.

DICKEY-john® WARRANTY

DICKEY-john warrants to the original purchaser for use that, if any part of the product proves to be defective in material or workmanship within one year from date of original installation, and is returned to DICKEY-john within 30 days after such defect is discovered, DICKEY-john will (at our option) either replace or repair said part. This warranty does not apply to damage resulting from misuse, neglect, accident, or improper installation or maintenance; any expenses or liability for repairs made by outside parties without DICKEY-john's written consent; damage to any associated equipment; or lost profits or special damages. Said part will not be considered defective if it substantially fulfills the performance expectations. THE FOREGOING WARRANTY IS EXCLUSIVE AND IN LIEU OF ALL OTHER WARRANTIES OF MERCHANTABILITY, FITNESS FOR PURPOSE, AND OF ANY OTHER TYPE, WHETHER EXPRESS OR IMPLIED. DICKEY-john neither assumes nor authorizes anyone to assume for it any other obligation or liability in connection with said part and will not be liable for consequential damages. Purchaser accepts these terms and warranty limitations unless the product is returned within fifteen days for full refund of purchase price.

**For DICKEY-john Service Department, call
1-800-637-3302 in either the U.S.A. or Canada**



Headquarters:

5200 Dickey-john Road, Auburn, IL USA 62615

TEL: 217 438 3371, FAX: 217 438 6012, WEB: www.dickey-john.com

Europe:

DICKEY-john Europe S.A.S, 165, boulevard de Valmy, 92706 – Colombes – France

TEL: 33 (0) 1 41 19 21 80, FAX: 33 (0) 1 47 86 00 07, EMAIL: europe@dickey-john.com