

RAM® Pod HD™ Installation Instructions (Side A)

For a video demonstration of this installation, visit www.rrammount.com/part/RAM-316-HD-NBU

Parts Index:

- A. RAM® Pod HD™ Base Sub-Assembly (QTY. 1)
 - B. ½" NPT Long Aluminum Pipe (QTY. 1)
 - C. 1.5" Ball Base with ½" NPT Female Thread (QTY. 1)
 - D. Standard Length 1.5" Double Socket Arm (QTY. 1)
 - E. 1.5" Ball Adapter Plate (QTY. 1)
- Ball plates may vary. Not included in all kits.**

Hardware Index:

- F. .9" x .75" Spacer (QTY. 1)
- G. .87" x 1.68" Spacer (QTY. 1)
- H. 1.31" x 1" Spacer (QTY. 1)
- J. 1.5" x 2.375" Spacer (QTY. 1)
- K. M8-1.25 x 60mm Hex Bolt (QTY. 1)
- L. M10-1.25 x 60mm Hex Bolt (QTY. 1)
- M. M10-1.5 x 60mm Hex Bolt (QTY. 1)
- N. M12-1.75 x 100mm Hex Bolt (QTY. 1)
- P. 1.25" Flat Washer (QTY. 1)
- Q. 1.25" Fender Washer (QTY. 1)
- R. .313" Flat Washer (QTY. 1)
- S. Foot Stabilizer Hardware Pack (QTY. 1)
(Optional, see reverse side)

Recommended tools:

- Socket Wrench Set
- Open-end Wrench Set

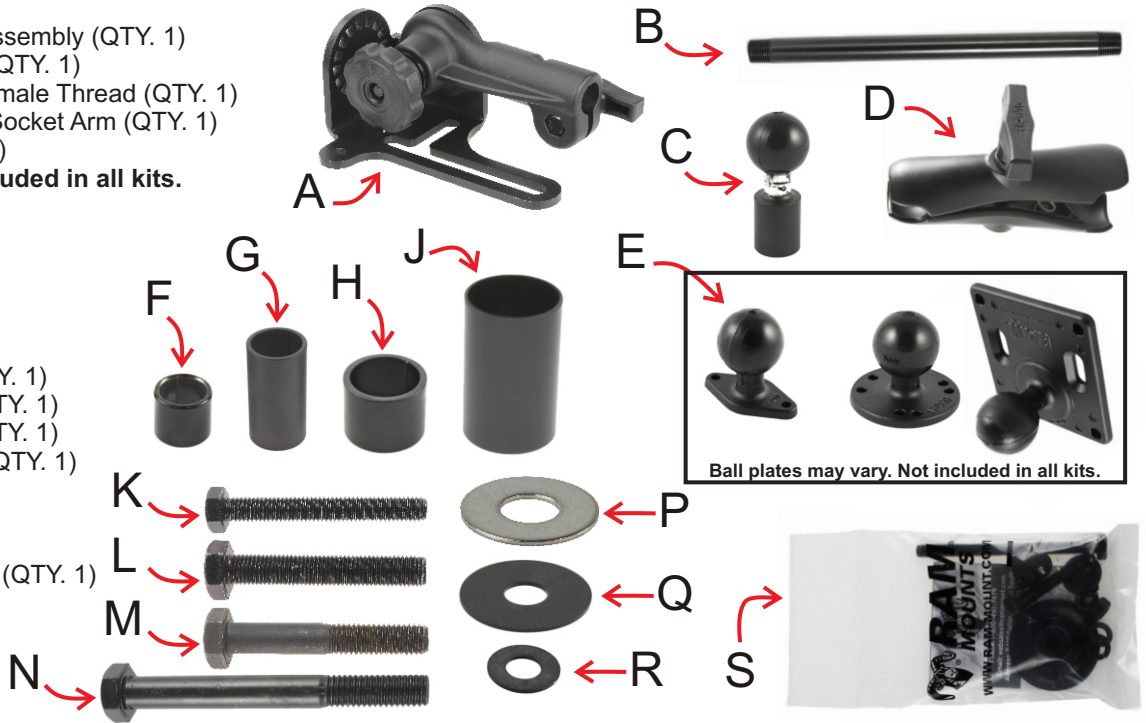

1. Expose and remove factory seat bolt in your vehicle:

Left Hand Drive Vehicles: Remove front left passenger seat bolt

Right Hand Drive Vehicles: Remove front right passenger seat bolt

2. Compare your factory bolt to the (K, L, M, N) bolts included in the Hardware Pack. Select the bolt whose thread pitch matches your factory seat bolt. Set other bolts aside.

3. Select the (F, G, H or J) spacer in the Hardware Pack that is best fitting for your seat. Be sure to consider both the width of the spacer, as well as the height of the spacer compared with the bolt selected in **Step 2**. Set other spacers aside.

4. Select any (P, Q, or R) washer that is appropriately compatible with the bolt selected in **Step 2**. Set other washers aside.

5. Disassemble (A) RAM® Pod HD™ Base as shown. Make special note of the washer order for **Step 7**. **Steel washer is closest to tightening knob.** (Diagram AA)

6. Position selected spacer over the seat bolt hole, resting flat inside the bolt head pocket. Place (A) RAM® Pod HD™ base over spacer, followed by washer from **Step 4**, and secure in place with bolt from **Step 2**. Tighten approx 90%. **Do not fully tighten yet.** (Diagram BB)

7. Reassemble components of (A) RAM® Pod HD™ Base as shown (remember washer order from **Step 5**). You may assemble in one of multiple variations in a fashion that leaves tightening knobs within the most convenient reach. Position pipe socket upward.



DIAGRAM AA



DIAGRAM BB

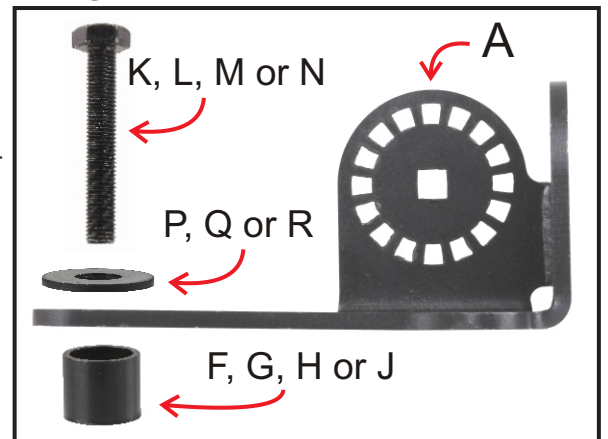

RAM MOUNTS®

RMR-INS-316-HDR

RAM Pod HD Installation Instructions (Side B)

8. With base not fully tightened yet, rotate (A) Base Assembly towards the center console of your vehicle to free up the most passenger space. Position as close as possible to the center console **without making physical contact with the console**. Once in position, fully tighten (K, L, M or N) bolt into passenger seat. Open-end wrench recommended.

9. Thread (C) Ball Base onto either end of (B) Aluminum Pipe. Insert opposite end of pipe into open hole on (A) RAM® Pod HD™ Base.

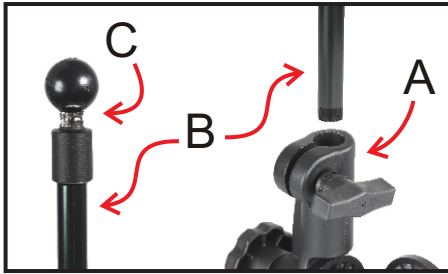

10. Attach double ball and socket components and adjust to desired position to complete assembly.

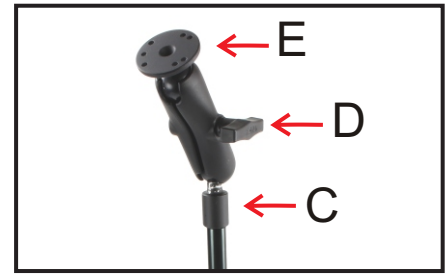

Foot Stabilizer Assembly Instructions (Optional)

If there is a 1.5 - 1.75" gap or 3 3/8 - 3 5/8" gap between the RAM Pod HD base and the floor of your vehicle, this foot stabilizer kit can be assembled to the bottom of your base to provide extra stabilization for the RAM Pod HD, most noticeable when driving on rough roads and/or holding heavier devices.

Hardware Index:

- T. Composite Stabilizer Foot (QTY. 1)
- U. 5/16"-18 x 2" Hex Bolt (QTY. 1)
- V. 5/16"-18 x 4" Hex Bolt (QTY. 1)
- W. 5/16" Split Lock Washer (QTY. 3)
- X. 5/16" Flat Washer (QTY. 1)
- Y. 5/16"-18 Steel Hex Nut (QTY. 3)
- Z. Hex Head Rubber Cap (QTY. 1)

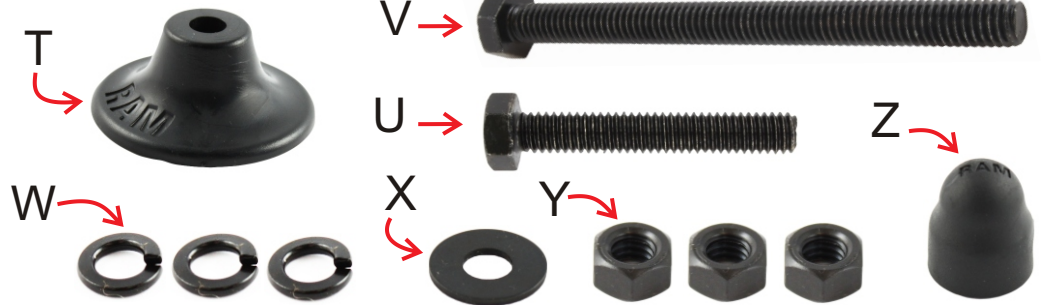

1. Select one of the following bolts and set the other aside:

- For a 1.5 - 1.75" Gap:** Select (U) Bolt
- For a 3 3/8 - 3 5/8" Gap:** Select (V) Bolt

2. Insert selected bolt upside down into (T) Foot, attach one (W) lock washer and tighten with one (Y) Nut. Thread second (Y) Nut along the middle of the bolt, and place another (W) lock washer over nut.



3. Using one of the available holes, place (A) RAM Pod HD Base over bolt.

4. Add (X) Washer, (W) Washer and (Y) Nut on top of RAM Pod HD Base. Adjust nuts along the bolt threads to configure the appropriate protrusion length of the stabilizer foot, to properly brace the RAM Pod HD when installed. Fully tighten all nuts with open-end wrench when configured.

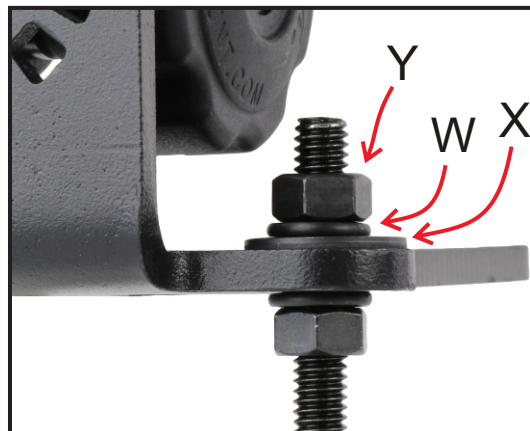
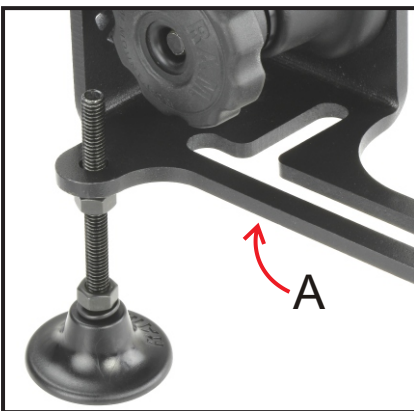

Attach (Z) Rubber cap when fully tightened.



RAM Mounting Systems
8410 Dallas Ave S
Seattle, WA 98108
Phone: (206) 763-8361
Fax: (206) 763-9615
www.rammount.com
support@rammount.com



RMR-INS-316-HDR