

N0622L, F0822L, N0922L, F1222L, N1322L/NCL, F1522L/NCL

Service Parts

This is the illustrated service parts list for the N0622, F0822, N0922, F1222, N1322 and F1522 remote low side ice machine heads.

Several models are listed together, be sure to select the correct part based on the complete model number, including voltage.

Voltage codes:

-1 = 115/60/1

The reservoir and related tubes changed in June 2012.

NCL units ship with a R407A TXV and are Nitrogen charged.

Contents

Cabinet - A Series	Page 2
Cabinet - D Series	Page 3
Refrigeration	Page 4
Water and Chute, Clear Reservoir Cover Models	Page 5
Water and Chute, White Reservoir Cover Units and D Series	Page 6
N0622L, N0922L, N1322L Evaporator System	Page 7
F0822L, F1222L, F1522L Evaporator System	Page 8
Gear Reducer and Motor	Page 9
Electrical Control and Harnesses	Page 10

N0622L, F0822L, N0922L, F1222L, N1322L/NCL, F1522L/NCL

Service Parts Cabinet - A Series

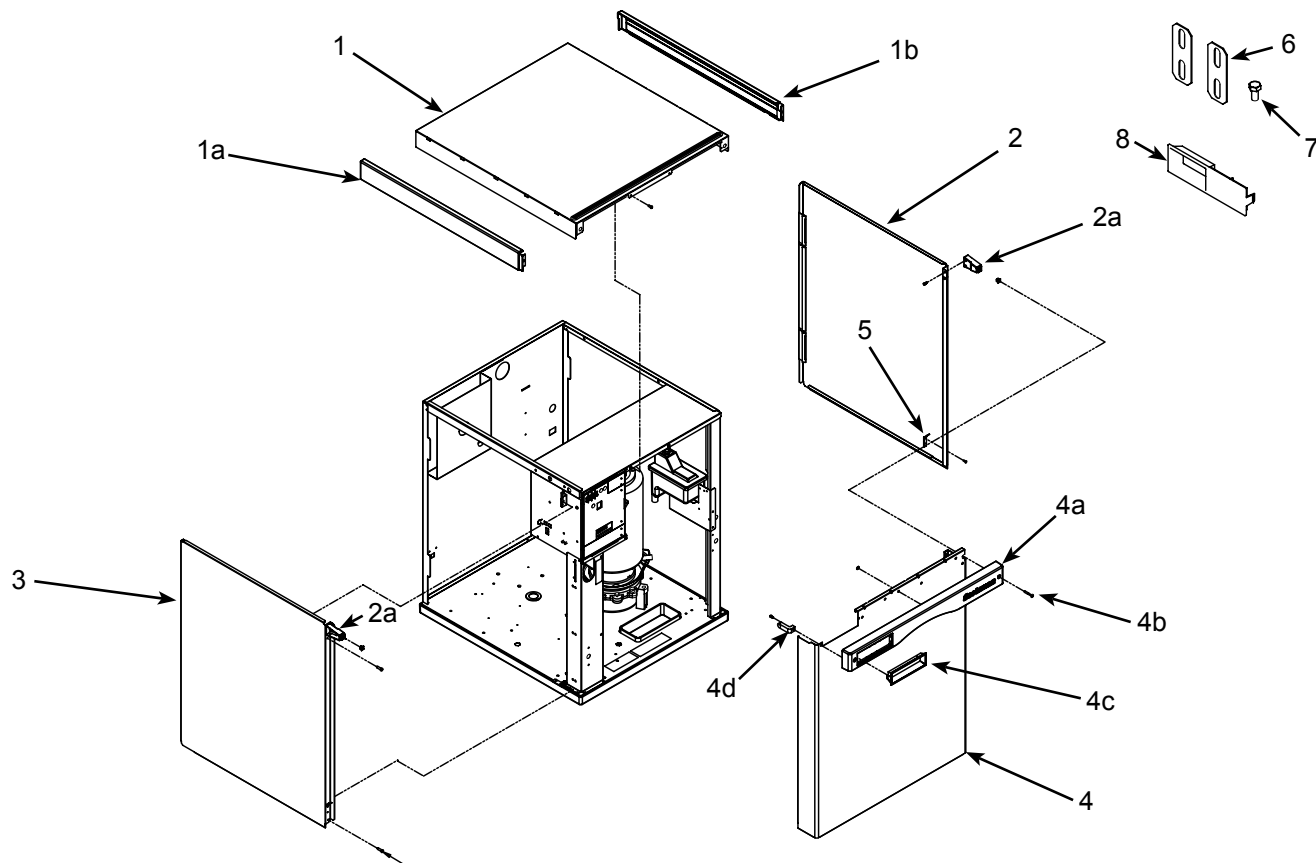

Item Number	Part Number	Description
1	A39579-021	Top panel
1a	02-4221-01	Left trim strip*
1b	02-4221-02	Right trim strip*
2	A39445-022	Right side panel, incl 2a and 5
2a	02-4215-01	Screw receptacle
3	A39444-024	Left side panel, incl 2a and 5
4	A39443-024	Front panel, complete. Includes 4a, 4b, 4c, 4d
4a	02-4214-01	Trim strip
4b	03-1735-03	Screw
4c	02-4284-01	Bezel
4d	02-4216-01	Gusset
5	A39571-001	Clip
6	A30911-015	Machine straps
7	03-1405-15	Cap screw
8	02-4284-02	Bezel, partial window**

* Side trim strips discontinued mid 2011

** Item 8 discontinued from production 2/9/2012

N0622L, F0822L, N0922L, F1222L, N1322L/NCL, F1522L/NCL

Service Parts Cabinet - D Series

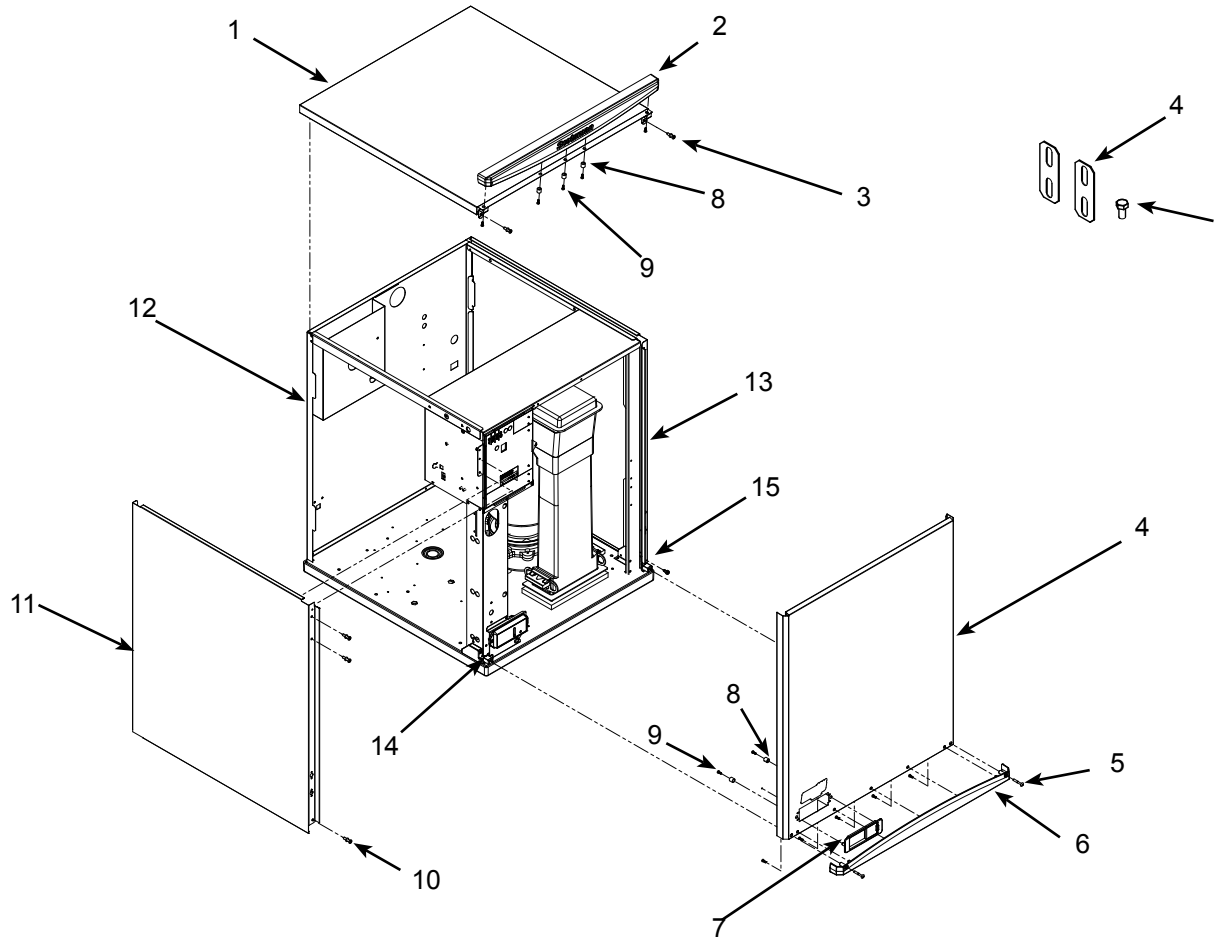

Item Number	Part Number	Description	Item Number	Part Number	Description
1	A40309-022	Top panel, includes item 2	13	A40335-022	Right side panel
2	02-4819-02	Trim strip	14	02-4823-01	Left panel mount
3	03-1404-10	Screw	15	02-4823-01	Right panel mount
4	A40308-029	Front panel, includes item 6&7			
5	03-1735-03	Screw			
6	02-4820-02	Trim strip			
7	02-4821-02	Bezel, includes standard door			
7a	02-4822-01	Door, bezel with handle			
7b	02-4822-02	Door, bezel secure			
8	02-4824-01	Spacer			
9	03-3836-02	Screw			
10	03-1404-10	Screw			
11	A40310-026	Left side panel			
12	A39179-001	Back panel			

N0622L, F0822L, N0922L, F1222L, N1322L/NCL, F1522L/NCL

Service Parts Refrigeration

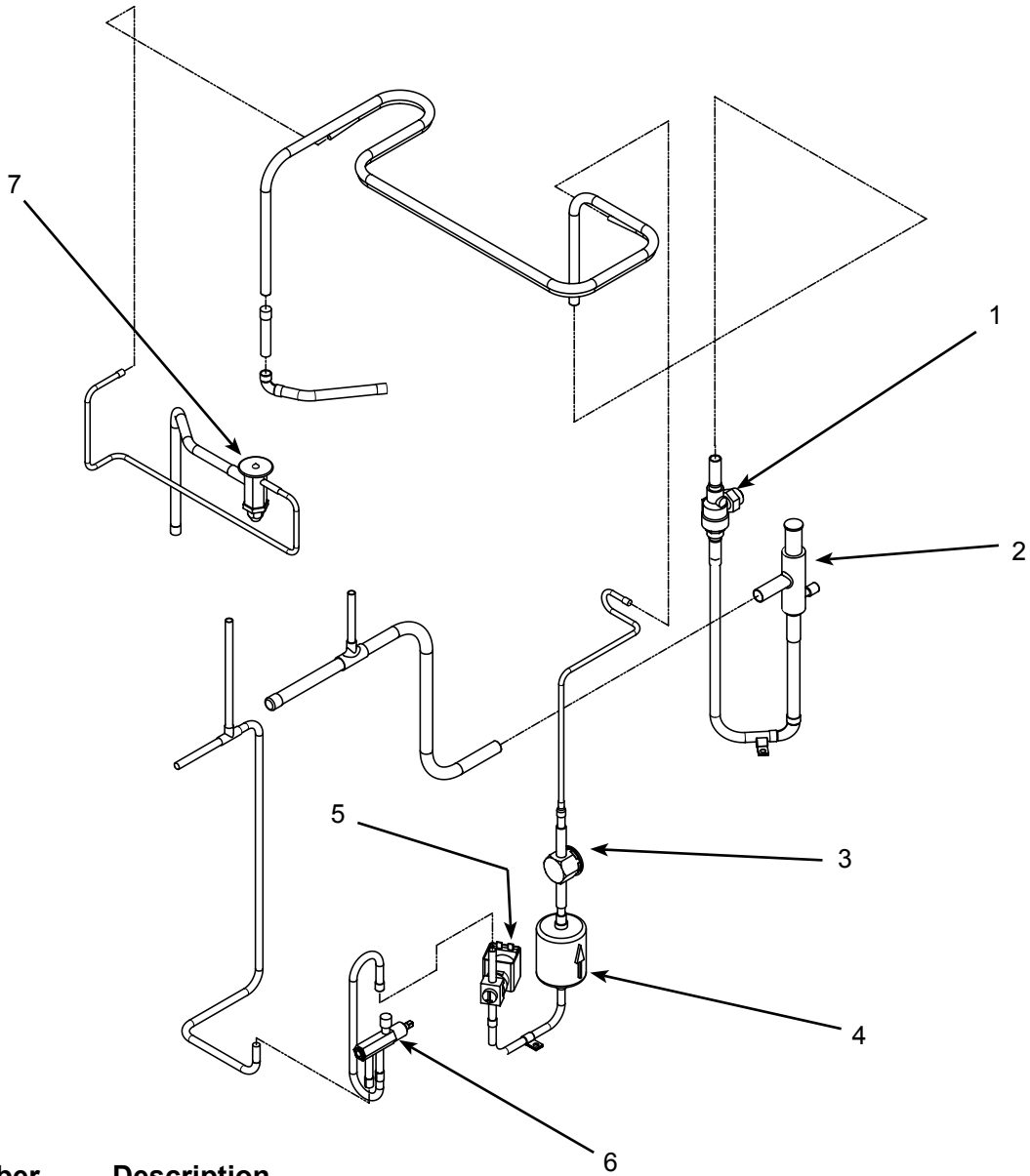

Item Number	Part Number	Description
1	11-0548-02	Ball valve
2	16-1143-01	EPR valve
3	16-0762-01	Sight glass
4	02-3319-02	Dryer
5	11-0493-02	Liquid line valve, 115 volt
6	16-1030-01	Liquid access valve
7	16-1144-22	TXV, N0622, F0822 (R404A)
	16-1144-24	TXV, N0922, F1222 (R404A)
	16-1144-23	TXV, N1322, F1522 (R404A)
8	16-1222-21	TXV, N1322, F1522 (R407A)
	02-4406-01	Insulation, TXV

N0622L, F0822L, N0922L, F1222L, N1322L/NCL, F1522L/NCL

Service Parts

Water and Chute, Clear Reservoir Cover Units

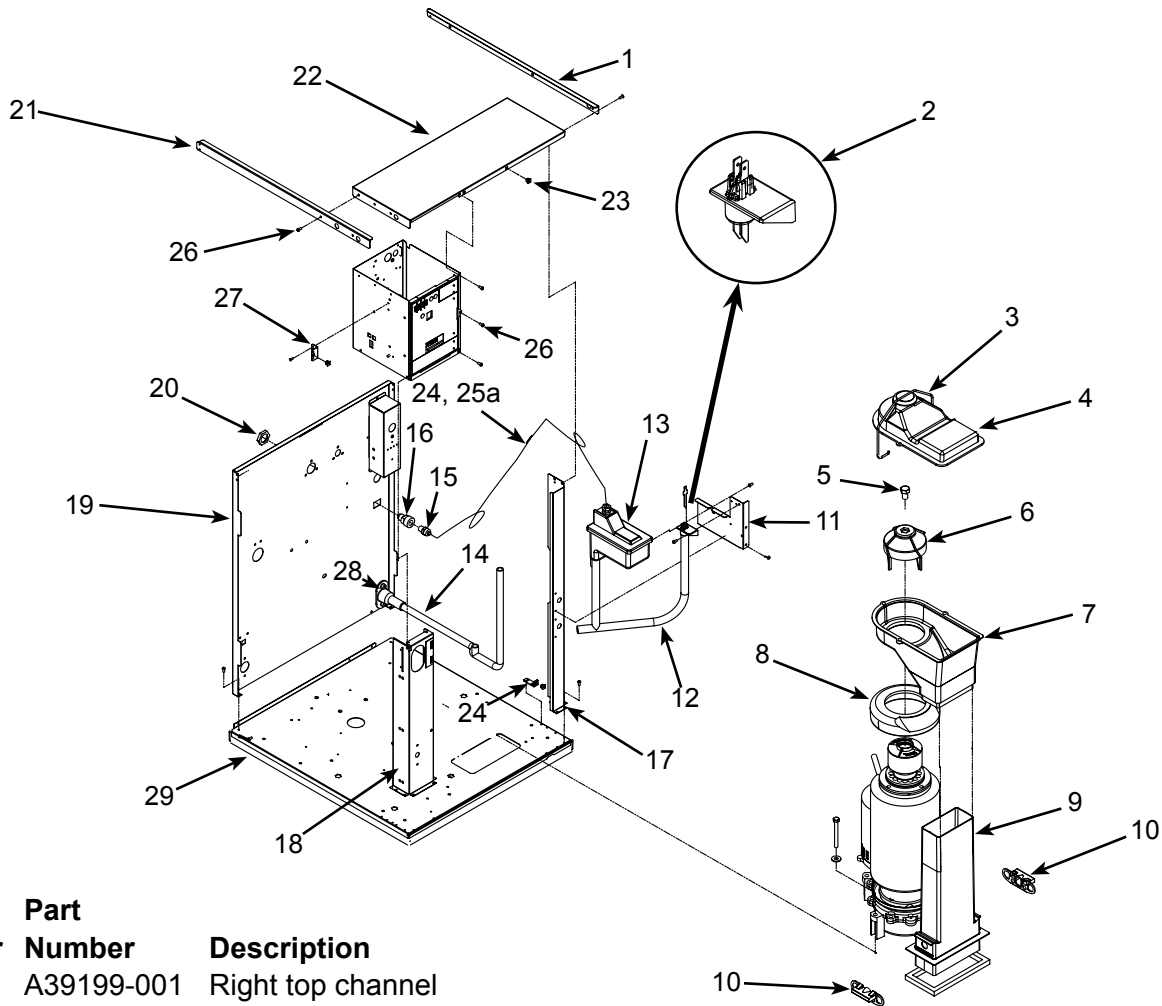

Item Number	Part Number	Description
1	A39199-001	Right top channel
2	02-4449-21	Water sensor
3	A34969-001	Bail clamp
4	02-2930-04	Chute cover
5	03-1405-52	Cap screw
6	02-3001-01	Ice sweep
7	02-3841-01	Ice chute
8	13-0929-01	Insul collar, flaker
	13-0929-02	Insul collar, nuggets
9	02-2929-04	Ice chute, lower
	02-2929-03	ice chute, lower*
10	A37708-021	Bin control set
11	A39200-001	Reservoir bracket
12	02-4338-01	Evaporator inlet hose
	A39336-001	Evaporator inlet hose*
13	02-3371-01	Water reservoir & valve
	02-3371-02	Float and arm only
	02-3266-03	Plunger/seat only
14	02-4339-01	Drain hose
	A39310-001	Drain hose*
		* N0622 or F0822
	15	16-1039-01 Connector, male
	16	16-0835-01 Flare fitting, male
	17	A39182-001 Post, right front
	18	A39184-001 Post, control box
	19	A39179-001 Back panel
	20	03-1394-01 Pal nut
	21	A39185-001 Left top panel
	22	A39181-001 Control box cover
	23	03-3804-01 Receptacle
	24	A38732-001 Panel mount
	25	13-0895-01 Tubing, order 3
	25a	16-0871-01 Insert (for valve end)
	26	03-1531-01 Screw
	27	A39025-001 Bracket
	28	02-3692-21 Drain fitting
	29	02-4524-21 Base assembly

N0622L, F0822L, N0922L, F1222L, N1322L/NCL, F1522L/NCL Service Parts

Water and Chute, **White Reservoir Cover Units and D Series**

Identification Reference: Units with this design also have water sensor in the reservoir. Use began June 18, 2012 with N1322R-32A serial number 12061320013354.

Item 12 changed August 2013, with serial number 13081320013114

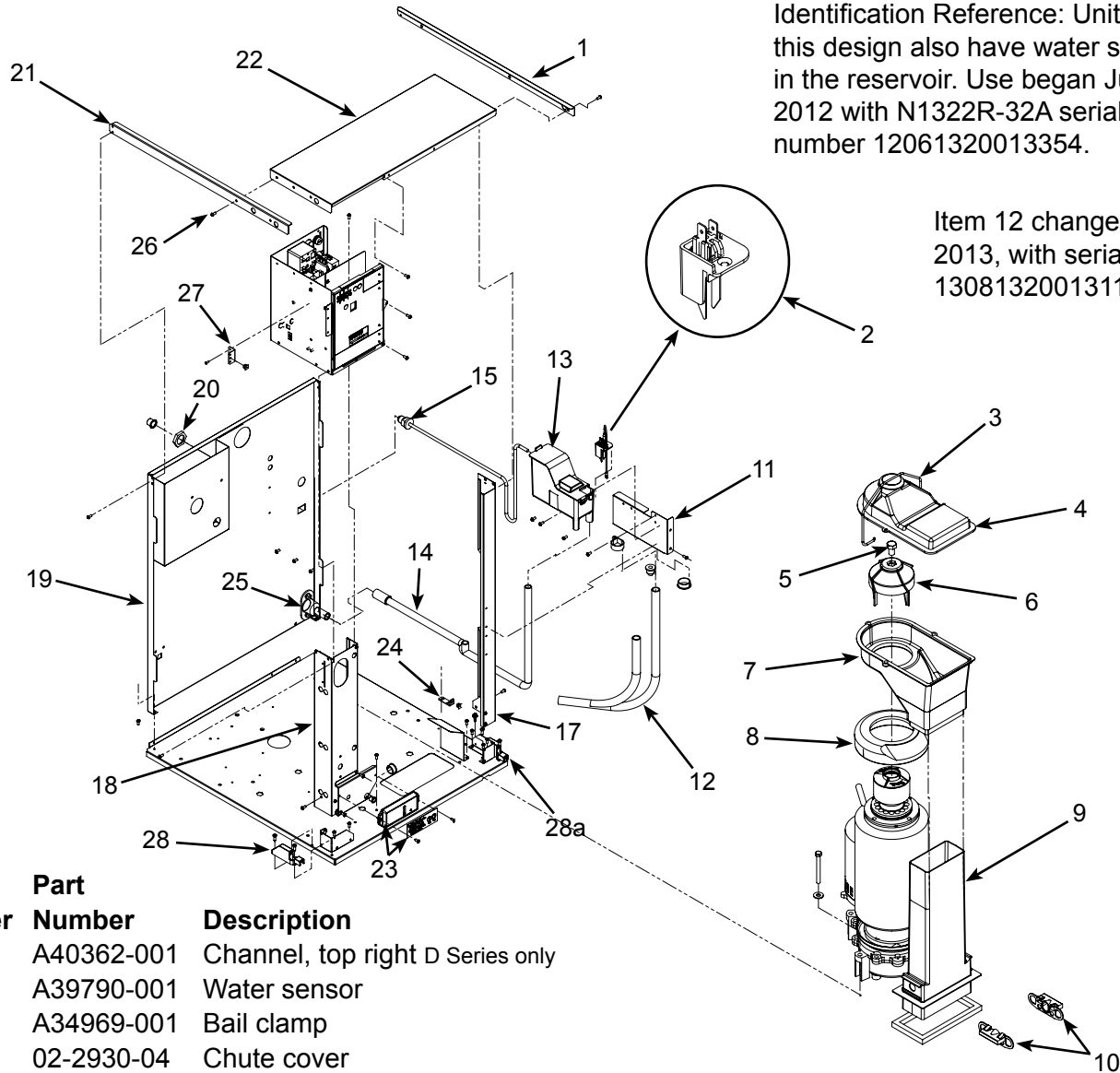

Item Number	Part Number	Description
1	A40362-001	Channel, top right D Series only
2	A39790-001	Water sensor
3	A34969-001	Bail clamp
4	02-2930-04	Chute cover
5	03-1405-52	Cap screw
6	02-3001-01	Ice sweep
7	02-3841-01	Ice chute
8	13-0929-01	Insulation collar, flakers
	13-0929-02	Insulation collar, nuggets
9	02-2929-04	Ice chute lower
	02-2929-03	Ice chute lower*
10	A37708-021	Bin control set (2)
11	A40029-001	Reservoir bracket
12	02-4752-01	Evaporator inlet hose
	A40189-001	Evaporator inlet hose*
13	A39789-001	Water reservoir & valve
13a	02-2217-02	Float and arm only
14	02-4708-01	Drain hose
	A40031-001	Drain hose*
15	16-1198-01	Fitting only
16	02-4524-21	Base
17	A39182-001	Post, right front
18	A39184-001	Post, control box
19	A39179-001	Back panel
20	03-1394-01	Pal nut
21	A40361-001	Channel, top left D Series only
22	A39181-001	Control box cover
23	11-0622-21	Lower light & sw panel
24	A38732-001	Panel mount
25	02-3692-21	Drain fitting
26	03-1531-01	Screw
27	A39025-001	Bracket
28	02-4823-01	Left panel mount
28a	02-4823-01	Right panel mount

N0622L, F0822L, N0922L, F1222L, N1322L/NCL, F1522L/NCL

Service Parts

N0622L, N0922L, N1322L Evaporator System

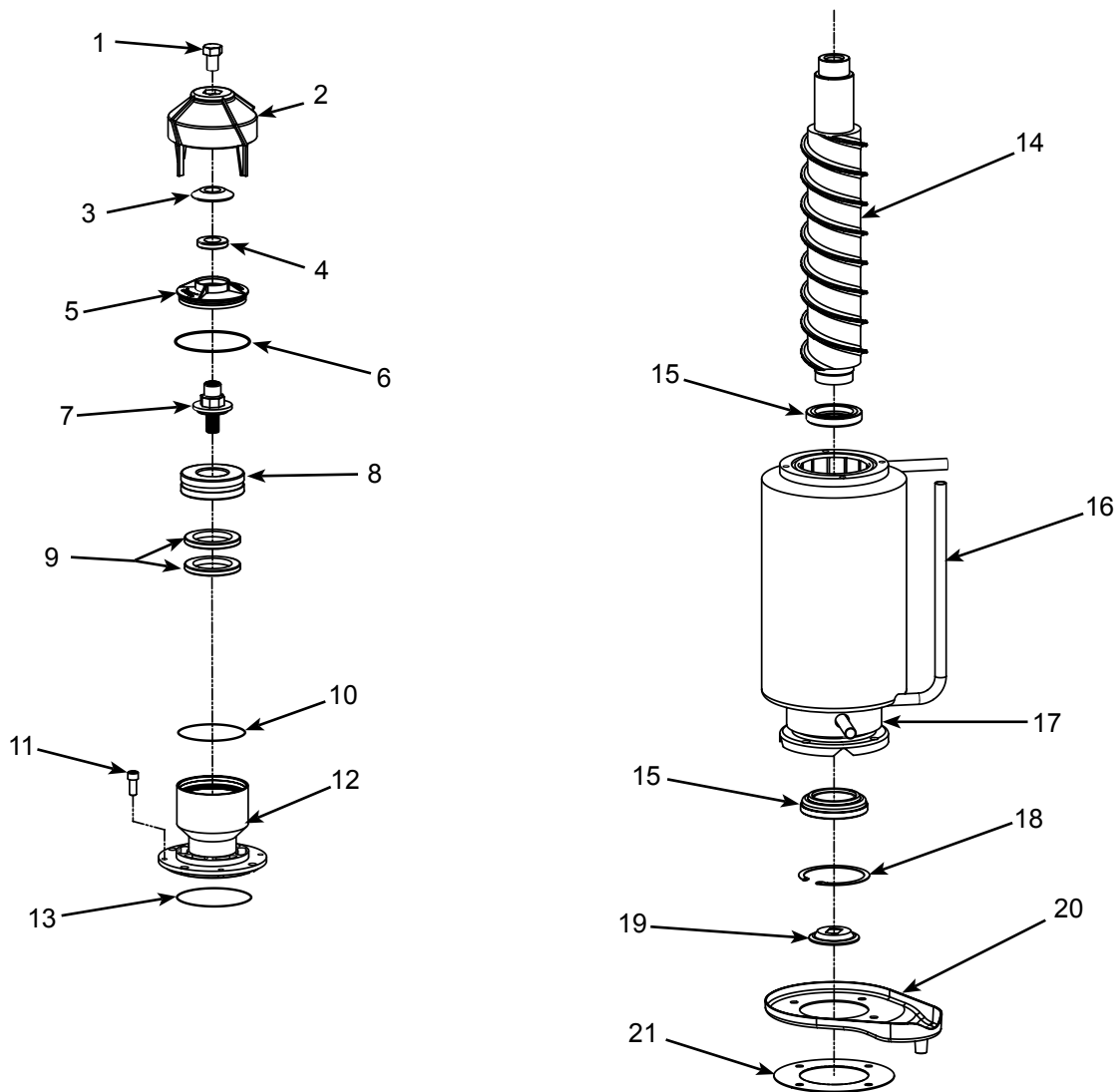

Item Number	Part Number	Description
1	03-1405-52	Cap screw
2	02-3001-01	Ice sweep
3	13-0871-01	Water shed
4	02-2978-01	Lip seal
5	02-3128-20	Cover, includes item 4
6	13-0617-54	O-ring
7	08-0660-01	Auger stud
8	A34559-020	Bearing
9	02-2977-01	Lip seal
10	13-0617-52	O-ring - to chute
11	03-1544-08	Screw, socket head
12	A32900-020	Nugget breaker assembly, includes items 3,4,5,6,8,9 and 13
13	13-0617-45	O-ring
14	A38071-021	Auger, N0622
	A38071-022	Auger, N0922, N1322
15	02-0929-23	Water seal
16	02-4350-21	Evaporator, N0622
	02-4352-21	Evaporator, N0922, N1322
17	02-4352-01	Collar
18	A32777-001	Retaining ring
19	02-4663-01	Water shed
20	02-3837-01	Drip pan
21	13-0704-00	Gasket

N0622L, F0822L, N0922L, F1222L, N1322L/NCL, F1522L/NCL

Service Parts

F0822L, F1222L, F1522L Evaporator System

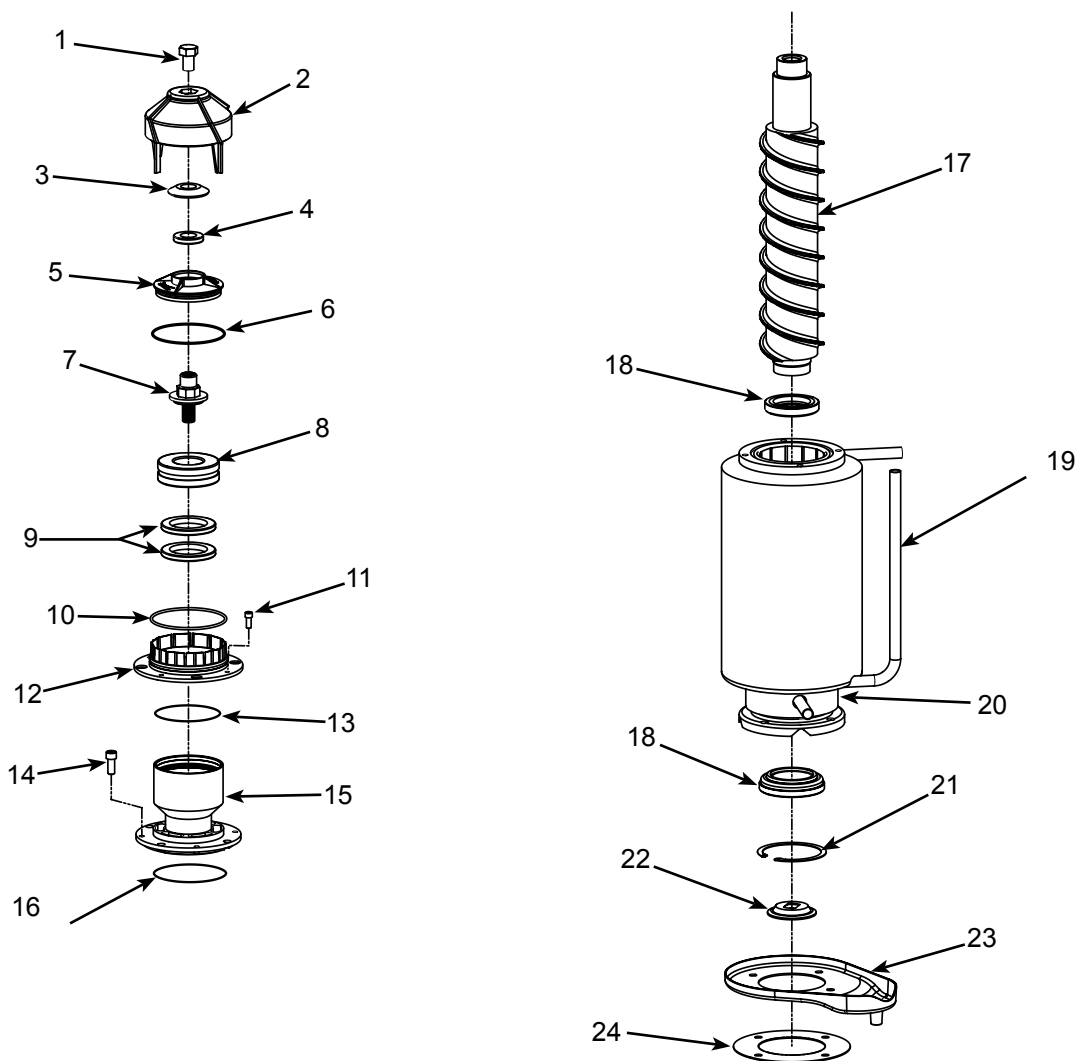

Item Number	Part Number	Description
1	03-1405-52	Cap screw
2	02-3001-01	Ice sweep
3	13-0871-01	Water shed
4	02-2978-01	Lip seal
5	02-3128-20	Cover, includes item 4
6	13-0617-54	O-ring
7	08-0660-01	Auger stud
8	A34559-020	Bearing
9	02-2977-01	Lip seal
10	13-0617-52	O-ring, to chute
11	03-1403-27	Screw
12	02-2916-01	Slotted collar
13	13-0617-49	O-ring, under slotted collar
14	03-1544-08	Screw, socket head
15	A34505-020	Flaker breaker assembly, includes items 3,4,5,6,8,9, and 16
16	13-0617-45	O-ring
17	A38071-021	Auger, F0822
	A38071-022	Auger, F1222, F1522
18	02-0929-23	Water seal
19	02-4350-21	Evaporator, F0822
	02-4352-21	Evaporator, F1222, F1522
20	02-4358-01	Collar
21	A32777-001	Retaining ring
22	02-4663-01	Water shed
23	02-3837-01	Drip pan
24	13-0704-00	Gasket

N0622L, F0822L, N0922L, F1222L, N1322L/NCL, F1522L/NCL

Service Parts Gear Reducer and Motor

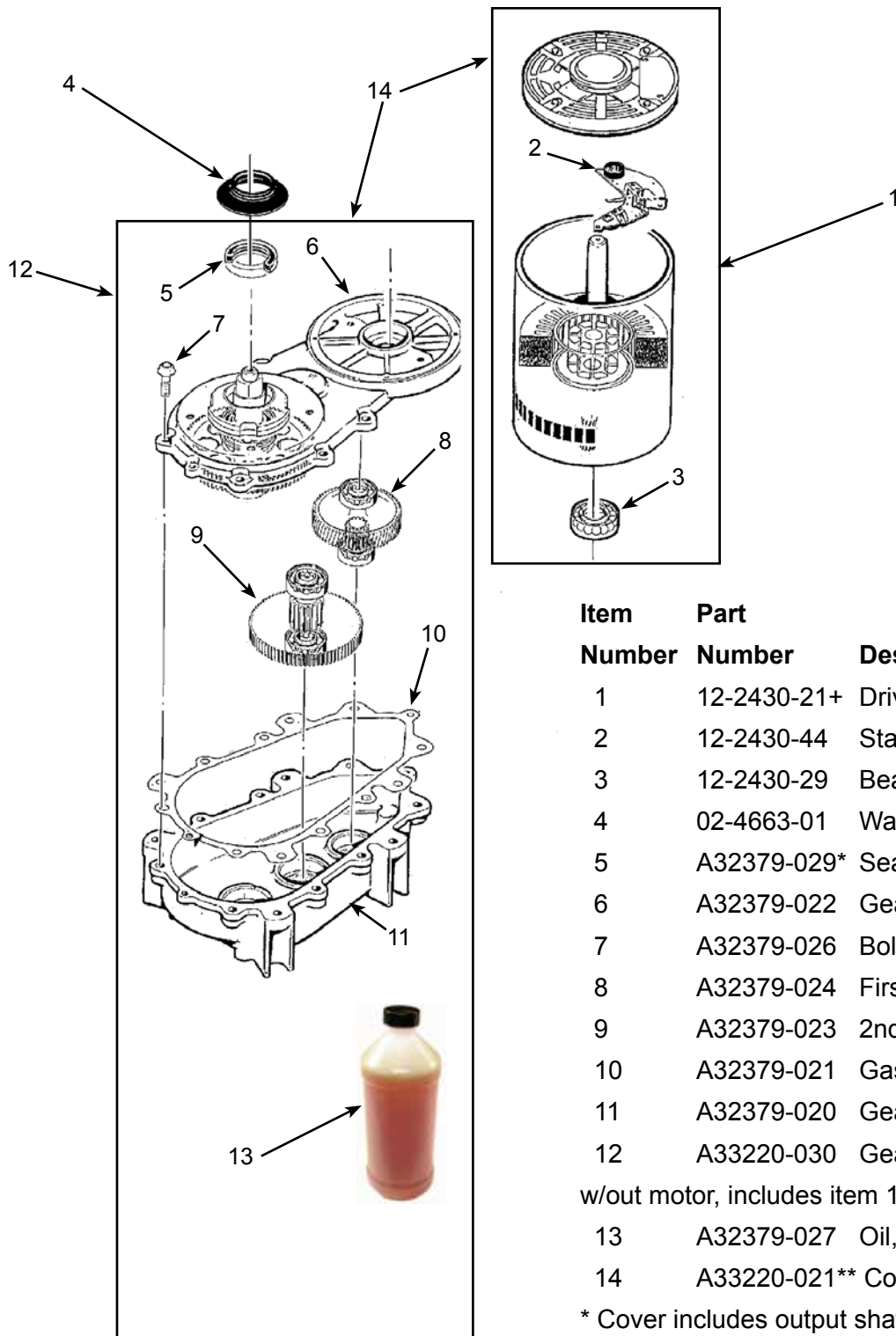

Item Number	Part Number	Description
1	12-2430-21+	Drive motor, 115 volt
2	12-2430-44	Start switch
3	12-2430-29	Bearing
4	02-4663-01	Water Shed
5	A32379-029*	Seal
6	A32379-022	Gearcase Cover*
7	A32379-026	Bolt
8	A32379-024	First Gear & Bearings
9	A32379-023	2nd Gear & Bearings
10	A32379-021	Gasket
11	A32379-020	Gear Case
12	A33220-030	Gearcase kit, assembled w/out motor, includes item 13
13	A32379-027	Oil, 1 Container
14	A33220-021**	Complete 115 volt

* Cover includes output shaft, seal, gear and bearings. If water has flowed thru the seal, the gearcase cover assembly should be replaced, not just the seal.

** Includes items 1, 12, and is charged with gear oil.

+ Includes items 2 and 3.

N0622L, F0822L, N0922L, F1222L, N1322L/NCL, F1522L/NCL

Service Parts Electrical Control and Harnesses

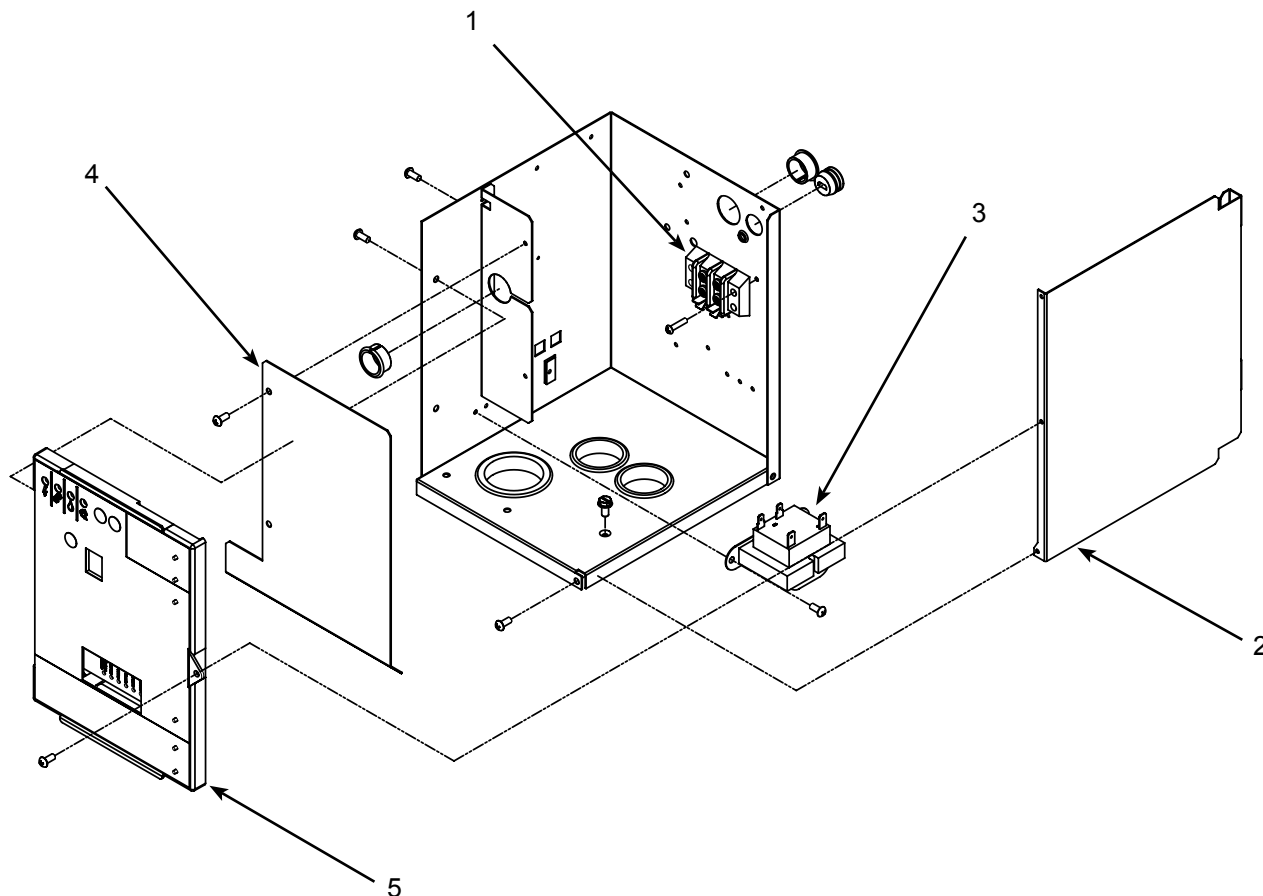

Item Number	Part Number	Description
1	12-2780-01	Terminal block
2	A39198-001	Control box side cover
3	12-2924-01	Transformer, 115 volt
4	A39216-001	Shield
5	11-0575-22	Controller for A or B series.
	11-0623-21	Controller for Prodigy Plus D series and all prior
	02-4407-01	Graphic overlay
	02-4076-01	Control box cover

Not Shown

12-2977-01	High voltage harness
12-2976-01	Low voltage harness
12-1638-19	Power cord

N0622L, F0822L, N0922L, F1222L, N1322L/NCL, F1522L/NCL

Service Parts Wiring Diagram

17-3215-01

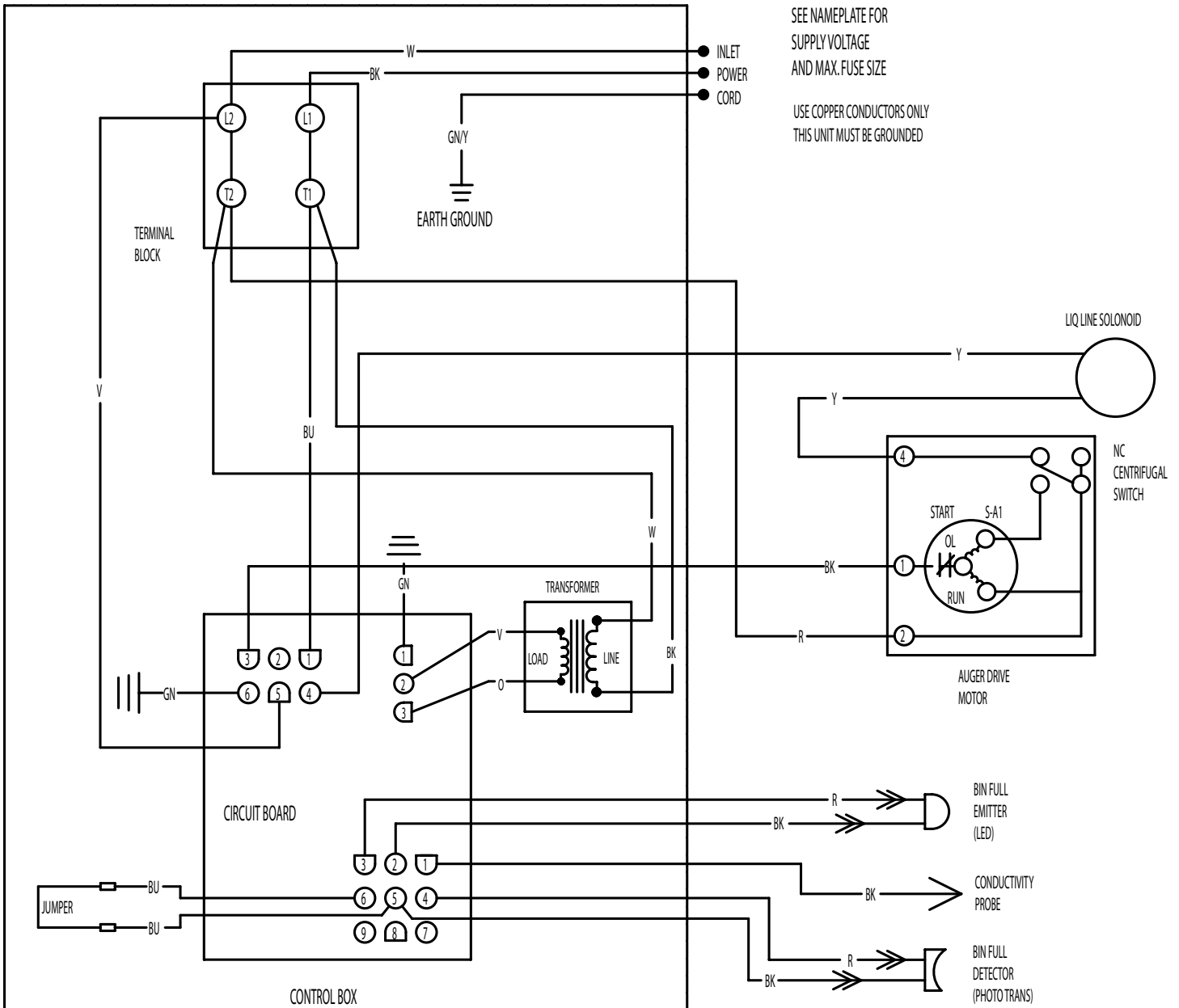

N0622L, F0822L, N0922L, F1222L, N1322L/NCL, F1522L/NCL

Service Parts Schematic Diagram

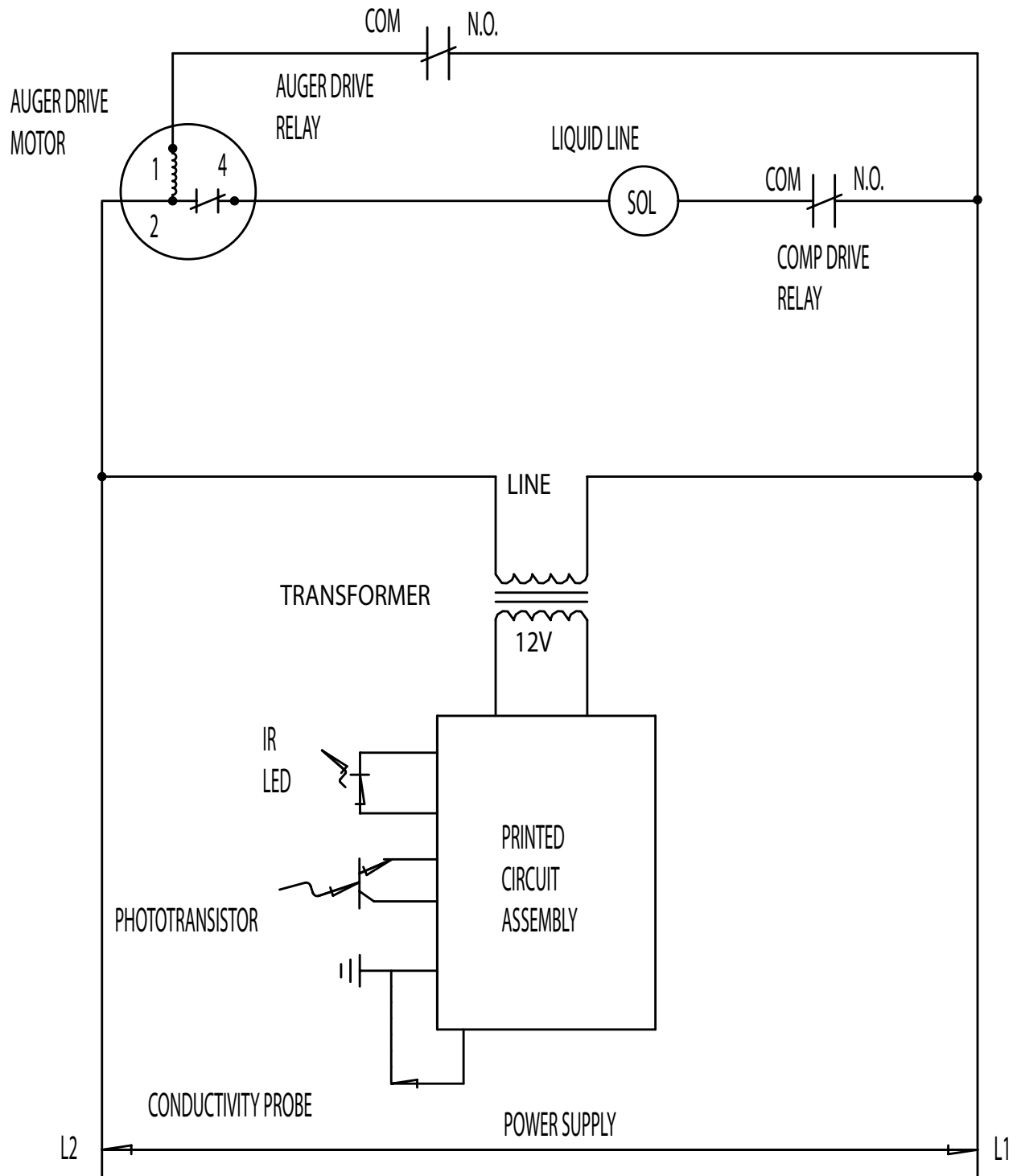

ALL CONTROLS SHOWN IN
ICE MAKING MODE