

GAMMA®

8900 EIs STRINGING MACHINE 6 PT SM SC MOUNTING



OWNER'S MANUAL

Issue 1 - June 2015

GAMMA.

8900 Els OWNER'S MANUAL

TABLE OF CONTENTS

WARRANTY.....	PAGE 2
FEATURES	PAGE 3
UNPACKING & ASSEMBLY INSTRUCTIONS.....	PAGE 4
POWER CONNECTION & CONTROLS.....	PAGE 11
CONTROL PANEL FUNCTIONS AND FEATURES.....	PAGE 12
DISPLAY SCREEN.....	PAGE 13
MACHINE FUNCTIONS.....	PAGE 14
STRING GRIPPER OPERATION	PAGE 19
MOUNTING THE FRAME.....	PAGE 20
STRINGING THE FRAME	PAGE 21
STRING LENGTH METER	PAGE 25
ADDITIONAL FEATURES.....	PAGE 26
PATHFINDER AWL.....	PAGE 27
MAINTENANCE & ADJUSTMENTS	PAGE 28
TROUBLESHOOTING TIPS.....	PAGE 30
PARTS LIST.....	PAGE 32
PARTS DRAWING	PAGE 33

LIMITED WARRANTY

GAMMA SPORTS warrants to the original purchaser that the 8900 Els stringing machine ("EQUIPMENT") purchased is free from defects in materials and workmanship for a period of five (5) years from the date of original purchase for mechanical parts (excluding electrical parts and string clamps), and for a period of one (1) year from the date of purchase for all electrical parts and string clamps. Should any defects develop under normal use within the specified time periods, GAMMA will at its option, repair or replace the defective EQUIPMENT provided it is returned to GAMMA prepaid at the purchaser's expense. This warranty does not apply to any damage or defect caused by negligence, abuse, misuse, unauthorized alteration, shipping, handling, or part wear and tear as a result of normal use.

Routine maintenance, adjustment, and cleaning required to ensure proper operation are the responsibility of the purchaser and are not covered under the terms of this warranty. These include, but are not limited to: String Clamp adjustment, as described on page 30, Clamp Base adjustment, as described on page 30, and the cleaning procedures listed on page 30.

GAMMA's obligation under this warranty is limited to repair or replacement of defective EQUIPMENT, and no one is authorized to promise any other liability. GAMMA shall in no event be liable for any incidental or consequential damages.

To return defective EQUIPMENT, a return authorization (RA#) must be obtained from a GAMMA customer service representative. The RA# must be marked on the outside of the shipping carton being returned. All returns must be shipped prepaid by the customer to GAMMA. Please retain the original shipping carton and packing materials for any future shipments. GAMMA will not be responsible for machines which are not sent in the original undamaged packaging.

A GAMMA Care Service Plan is also available through GAMMA customer service, call 800.333.0337 for details.

MACHINE FEATURES



MACHINE FEATURES

- ❖ Electric Constant Pull Tensioner with 11.0 to 90.0 lbs Tension Range
- ❖ Digital Tension Setting with LCD Display
- ❖ Quick Closing Linear String Gripper
- ❖ Professional Six Point “*Quick Mount*” Racquet Mounting System- Accommodates All Racquets
- ❖ Auto-Release Cam-Lock Swivel Base Clamps
- ❖ 4 Tooth Universal String Clamps
- ❖ High Strength Extruded Aluminum Frame with Durable Anodized Finish and Extra Large Padded Tool Tray
- ❖ Unique Internal Drawer System for Storing Tools and Adaptors
- ❖ Convenient Foot Actuated Tensioner Switch
- ❖ String Length Meter



8900 EIs

Unpacking Instructions & Contents

Instructions for Unpacking and Preparing for Assembly

The stringing machine is shipped in three cartons, a large master carton for the stringing machine base with tensioner module and accessories, a medium carton for the turntable and mounting system and a smaller carton for the floor stand post and base legs. **Please save the cartons and packing materials for possible shipments in the future.** Gamma Sports cannot be responsible for machines that are not returned, shipped in their original, undamaged packaging. The tools you will need to assemble the machine are provided with the machine. Due to the weight of the tensioner unit, you may need the assistance of someone to help lift the tensioner unit out of the carton.

Once the cartons are opened, remove all inner cartons and check to be sure that all parts are present and accounted for.

Contents of Floor Stand Carton (MMU3-19)

- (1) Lower Column
- (1) Upper Column with Flange Plate
- (4) Legs
- (4) M8 x 30 Flat Head Screws
- (4) M8 x 35 Cap Screws
- (4) M6 x 20 Cap Screws
- (1) String Reel Holder (M8 Threaded Pin), (1) Knob, (10) Spacers, & (2) M8 Washers

Contents of Mounting System Carton (MMU3-25)

- (1) Turntable Assembly w/ String Clamp Base and Mounting Stands w/ Frame Support Slide, Side Supports, and Adapters
- (2) String Clamps
- (1) Package of spare plastic adapters for frame and mounting system supports
- (1) 17mm Socket

Contents of Machine Base Carton (MMU3-16)

- (1) Stringer Assembly Unit w/ Tensioner Module
- (1) Power Cord
- (1) AC Adaptor
- (1) Foot Pedal Tensioner Switch
- (1) Stringing Tool Set - Includes 1 ea Diagonal Cutter, Bent Nose Pliers, Straight Nose Pliers, Starting Clamp, Straight Awl & Pathfinder Specialty Awl
- (1) Tools for assembly and maintenance

ASSEMBLY INSTRUCTIONS

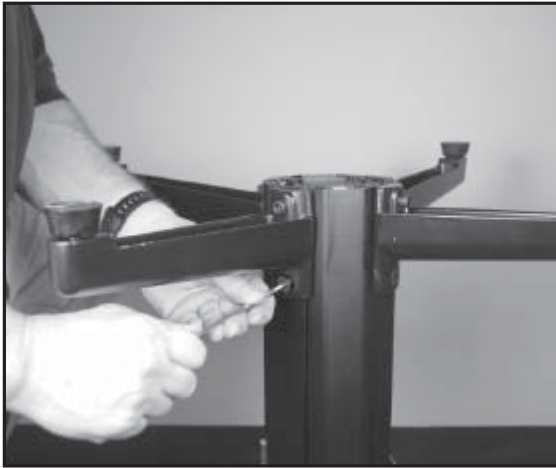

Floor Stand Leg Assembly

The stringing machine uses a four leg floor stand design. The legs must be assembled to the Lower Column before use. Remove all parts from the shipping carton to confirm that contents match the parts list.

Align the holes in the Leg Flange with the matching holes in the Lower Column. Secure the leg with one M8x30 flat head screw through the upper hole, and one M8x35 socket head cap screw through the bottom hole. Repeat this procedure for the three remaining legs.

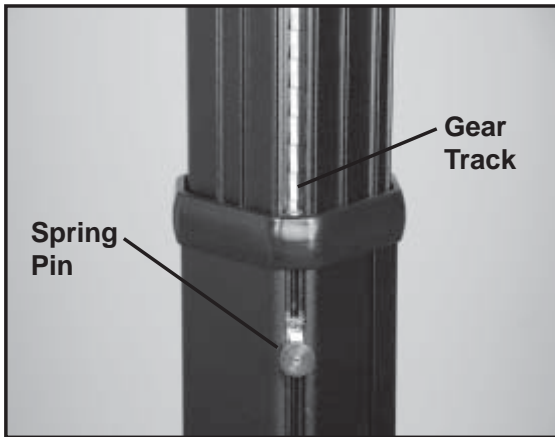

Floor Stand Assembly

The floor stand features a ratcheting Self-Locking system that incorporates a Spring Pin on the lower column to engage a gear track in the upper column. To set the Spring Pin to engage or disengage the Gear Track, pull the Spring Pin Knob out from the housing and rotate it 90 degrees to position the Knob Key into the deep or shallow slot of the Spring Pin Housing. When the Knob Key is positioned in the deep slot, the Spring Pin will be in the Self-Locking position and will engage the Gear Track. When the Knob Key is set

in the shallow slot, the Spring Pin will be retracted and not engage the Gear Track.

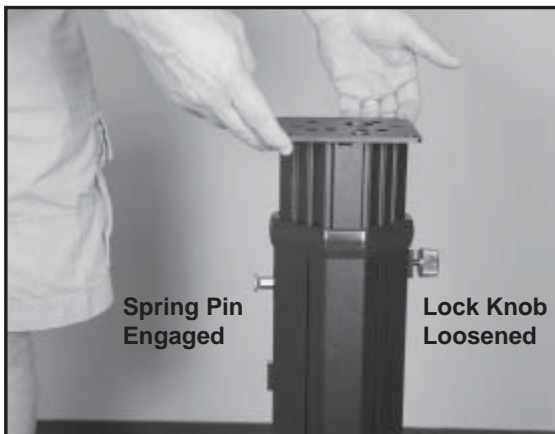

Floor Stand Assembly

With the Spring Pin engaged and the Knob Key positioned in the deep slot, loosen that Lock Knob and lift the upper column. As the upper column is lifted out of the lower column, the Spring Pin will ratchet as it engages and disengages the teeth of the gear track.

To lower the upper column, loosen the Lock Knob and while holding and supporting the upper column, pull out the Spring Pin, set the Knob Key into the shallow slot and lower the upper column.

Helpful Tip: When setting the height, it is best to start from the lowest position and gradually raise the height until the Self-Locking Spring Pin is engaged in the Gear Track at the desired height.

ASSEMBLY INSTRUCTIONS



Attaching the Floor Stand to the Machine Base

Refer to the instruction sheet provided with the floor stand for detailed instructions on which holes of the flange plate to use and align with the threaded inserts located in the slots on the underside of the machine base.

With the floor stand assembled and the upper column locked into position at the lowest height, orient the floor stand so that the string reel holder will be positioned on the left side of the machine base and bolt the floor stand to the underside of the machine base. The

floor stand can be assembled to the machine base with the machine base laying on the floor, or by setting the machine base on top of the floor stand with the help of an assistant to align and balance the machine base on the flange plate while installing and tightening the bolts from the underside.

Caution: To prevent damaging the threads of the inserts in the machine base, do not over-tighten the bolts.



Raising the Height of the Machine

To raise the height of the machine, the Knob Key of the Spring Pin should be positioned in the deep slot of the housing to ensure that the Spring Pin is in the Self-Locking position and engaged with the Gear Track. Loosen the Lock Knob and with the help of an assistant, lift the machine base until the desired height is reached. When the desired height is reached, tighten the Lock Knob.

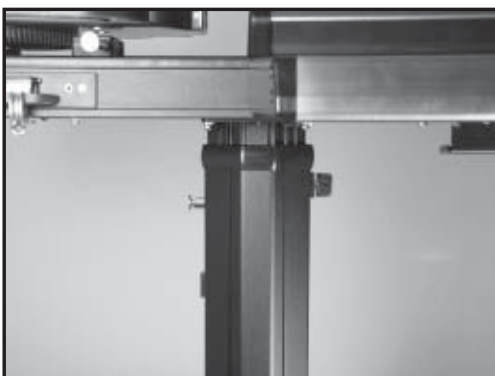

Lowering the Height of the Machine

To lower the machine, you will need the help of an assistant. With one person holding up and supporting the base of the machine, loosen the Lock Knob, pull out the Spring Pin and set the Knob Key into the shallow slot of the spring pin housing. Carefully lower the machine base until it comes to rest on the top of the Lower Column. Pull out the Spring Pin and position the Knob Key into the deep slot of spring Pin housing. Lift the machine base until the Spring Pin engages the first tooth of the Gear Track and tighten the Lock Knob, or

continue raising the machine until the desired height is reached and then tighten the Lock Knob.

CAUTION: To prevent damage to the string gripper, never lift or move the machine by the string gripper.

ASSEMBLY INSTRUCTIONS



Tool Tray Installation

The Tool Tray will be attached to the aluminum extruded machine base on the right hand side below the tensioner. To install the tool tray orient the tray at an angle and carefully insert the keyed tabs into the horizontal slot along the top edge of the base.

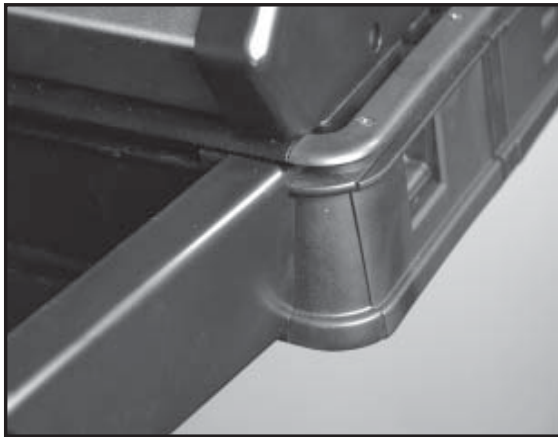

With the keyed tabs located within the slot in the machine base slide the tray to the right edge of the machine and next to the corner cap of the base. Rotate the tray down until it is flush against the machine base.



Secure the bracket on the rear of the Tool Tray to the machine base with two hex head bolts. Align the two holes in the bracket with the threaded holes in the threaded insert located in the machine base. Tighten the bolts with a 6mm hex wrench.

Caution: To prevent damaging the threads of the inserts in the machine base, do not overtighten the bolts.

Note: If the holes in the bracke do not line up with the holes in the threaded insert, loosen the set screw in the threaded insert and slide the threaded insert to the left or right until the

holes line up and tighten the set screw to lock the threaded insert in place.

ASSEMBLY INSTRUCTIONS

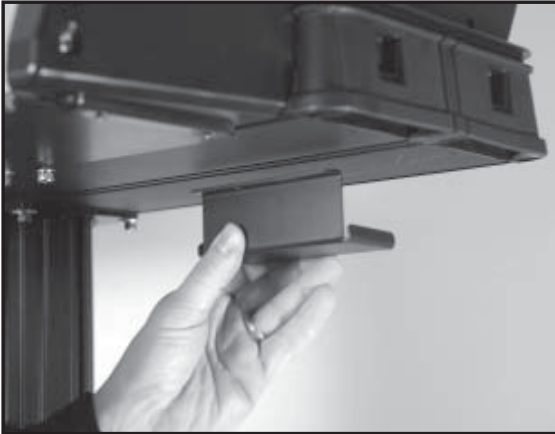

AC Power Adapter Storage Shelf

The AC Power Adapter Storage Shelf provides a means to secure and protect the power adapter by storing it safely under the machine base. This will reduce a potential tripping hazard as well as eliminate potential damage to the AC Power Supply if laying on the floor.

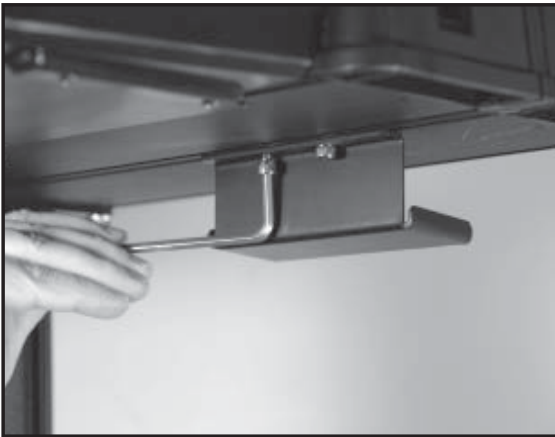

AC Power Adapter Storage Shelf

Mount the Storage Shelf to the threaded insert in the machine base near the rear right corner. Align the holes in the storage shelf bracket with the holes in the threaded insert. Use a 6 mm hex wrench to tighten the two hex head cap bolts.

Caution: To prevent damaging the threads of the inserts in the machine base, do not overtighten the bolts.

Note: If the holes in the bracket do not line up with the holes in the threaded insert, loosen the set screw in the threaded insert and slide

the threaded insert to the left or right until the holes line up and tighten the set screw to lock the threaded insert in place.



AC Power Adapter Storage Shelf

Place the AC Power Adapter onto the storage shelf. The excess cable can be coiled up and placed between the top of the AC Power Adapter and the machine base.

ASSEMBLY INSTRUCTIONS

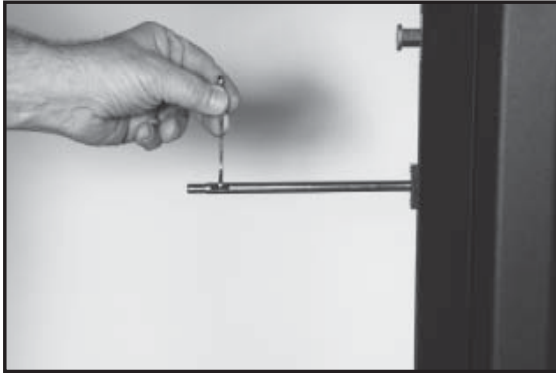

String Reel Installation

The String Reel Holder pin is an 8 mm rod with threads on both ends and flat surfaces machined on one end. Thread the end of the rod without the flat surfaces into the threaded boss on the right side of the Lower Column. Using the M6 open end wrench positioned on the flat surfaces, securely tighten the rod to the Lower Column.

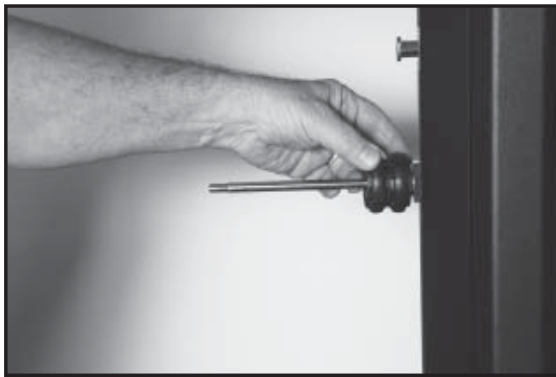

The String Reel Holder can hold up to 4 reels of string (depending on the size of the string reel). Before placing the first reel on the rod, slide two spacers over the pin and slide them to the boss on the Lower Column.

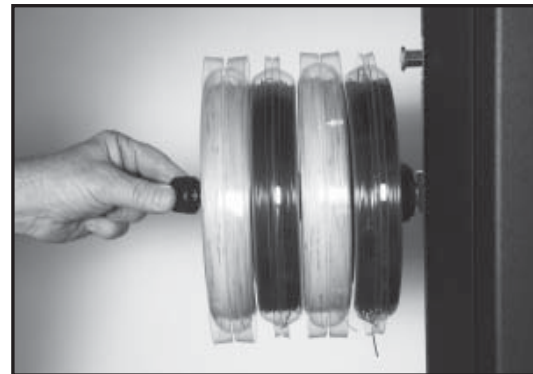
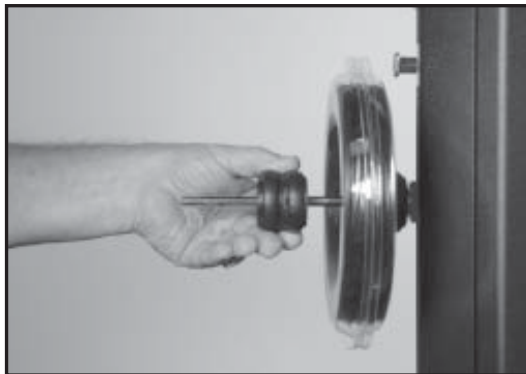

After the first reel is placed onto the rod, place two spacers between each reel to provide enough space between reels to allow them to turn freely without rubbing against one another. (To provide a smooth feed to the String Length Meter, place the reels on the rod so the string spools off the reel from the underside of the reel).

After the last reel is installed, place two washers on the rod and attach the threaded knob to the end of the rod.

Note: The String Reel Holder can be repositioned anywhere you wish on the lower column by loosening the set screws in the threaded boss and repositioning the threaded boss in the lower column.

ASSEMBLY INSTRUCTIONS

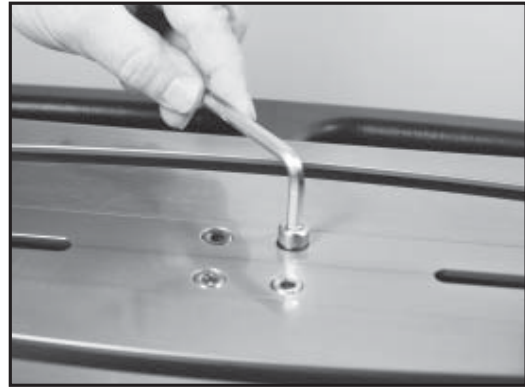
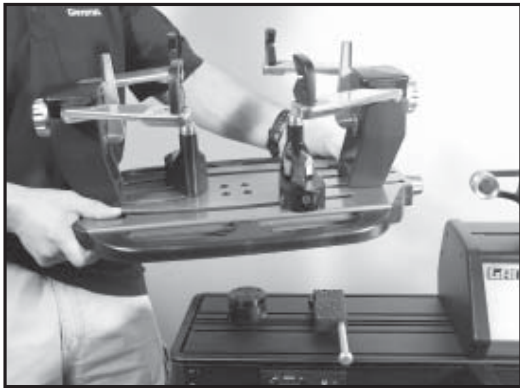

Turntable and Mounting System Installation

To install the Turntable position the Turntable over the turntable pin and align the holes in the turntable with the holes in the turntable pin. Insert the bolts through the holes in the turntable and turntable pin and tighten with an M6 hex wrench.

STRING CLAMP INSTALLATION

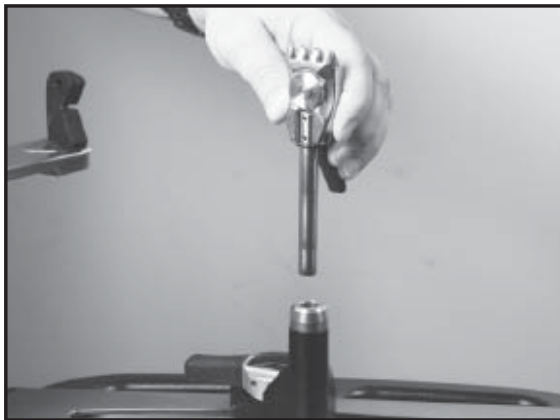

String Clamp Installation

The post of the String Clamp and tube of the String Clamp Base may be treated with grease to provide protection against corrosion during shipping and while in storage. Remove any excessive grease with a clean cloth prior to use. The post and tube may also be cleaned with isopropyl alcohol. After this type of thorough cleaning, the post and tube should be treated with a light coating of machine oil to protect the surfaces against corrosion and to ensure smooth operation.

POWER CONNECTION & CONTROLS

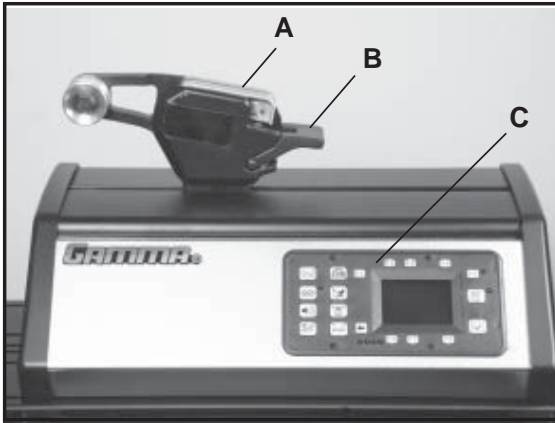

Front Panel Features

- A - String Gripper
- B - Tension Lever Switch
- C - LCD Display and Control Panel

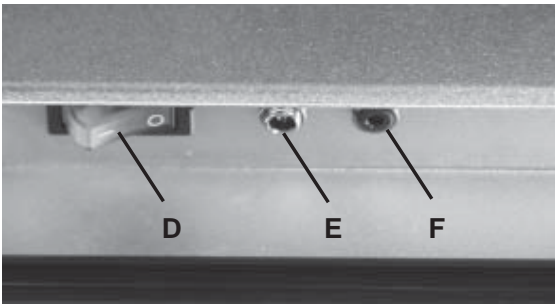

Back Panel Features

- D - Power Switch
- E - A/C Power Cord Socket
- F - Foot Pedal Switch Receptacle

Instructions for Power Connection and Controls

CAUTION ! Before connecting to the power supply, check the voltage source that the machine is being connected to. The acceptable range of input voltages for this machine is between 100 V and 240 V @ 50 to 60 Hz. If you have any questions regarding the input voltage supply for your area, please ask your electric utility company.

To install the power cord, insert the female end of the power cord into the AC Adapter and then insert the female end of the cord from the AC Adapter into the A/C Power Cord Socket "E" located under the back panel of the tensioner. Plug the male end of the power cord into a grounded power outlet. When using extension cords, use grounded heavy duty extension cords rated for 15 AMP service.

To connect the Foot Pedal Switch, insert the male pin at the end of the Foot Pedal Switch cord into the Foot Pedal Switch Receptacle "F" located under the back panel of the Tensioner.

Switch on the machine by pressing the On-Off Power Switch on the back panel. At start-up, the machine will perform a self diagnostics check.

**WARNING! FOR INDOOR USE ONLY.
NEVER OPEN UNIT WITH POWER CONNECTED.
CHILDREN SHOULD NEVER BE PERMITTED TO OPERATE THIS
MACHINE WITHOUT ADULT SUPERVISION.**

CONTROL PANEL FEATURES



ESC Button - Press to return to the Stringing Screen from the Settings Screen, String Length Meter Screen or to cancel a change being made to one of the functional settings.



KNOT Button - Press once to enable and display the Knot Icon - Press again and hold while the Knot icon is displayed to highlight the setting and make changes.



SOUND Button - Press to turn on or turn off beeper. When in the Settings Screen, the Sound Icon will include an "X" when Beeper is disabled and ")))" when the beeper is enabled.



PULLING SPEED Button - Press once to display the Pulling Speed Icon - Press again and hold while the Pulling Speed Icon is displayed to highlight the setting and make changes.



MAIN/CROSS String Button - Press to select and display the Main String Tension Setting or the Cross String Tension Setting.



PRE-STRETCH Button - Press once to enable and display the Pre-stretch Icon - Press again and hold while the Pre-stretch Icon is displayed to highlight the setting and make changes.



STRING LENGTH METER Button - Press to enable and display the String Length Meter - Pressing again will toggle the measurement units between feet (FT) and meters (M).



LBS/KG Button - Press to toggle the Tension Setting between LBS and KG.



ENTER Button - Press to confirm and save changes to any machine settings and to zero the String Length Meter.



RETURN Button - Press to return to the Stringing Screen from the Settings Screen, String Length Meter Screen or to cancel a change being made to one of the functional settings.



MEMORY Button - Press to scroll through 9 programmable Memory Settings (M1-M9) - Press and hold for 5 seconds to enable Basic Stringing Mode (M0).



F1 Button - Press to display the Settings Screen to view and make changes to any of the machine settings. Pressing and holding the F1 button for 5 seconds will display the Information Screen, which includes the total number of strings pulled on the machine. Pressing the ESC or RETURN button will exit from the Information Screen.



F5 Button - Press to reverse the order in which the Memory Settings are scrolled through - When the LED is illuminated the Memory Settings will scroll in decreasing order.



F2-F3-F4 Buttons - Press to increase String Tension values in the tens place (F2), units place (F3) and tenths place (F4) and press to increase setting values for Knot, Pre-stretch and Speed.



F6-F7-F8 Buttons - Press to decrease String Tension values in the tens place (F6), units place (F7) and tenths place (F8) and press to decrease setting values for Knot, Pre-stretch and Speed.

DISPLAY SCREENS



Language Selection Screen

At start-up, if a language other than English is desired, press any one of the F6-F8 buttons when the Start-up Screen appears to change to the Language Selection Screen. Pressing any one of the F2-F8 buttons will scroll through the available languages. When the desired language is highlighted, confirm by pressing the Enter Button.



Self Diagnostic Test Screen

During start-up, the machine will automatically perform a self-diagnostic test as the gripper moves from left to right and back to the left. The diagnostic checks will appear on the display in the selected language.



Settings Screen

Pressing the F1 button will open the Settings Screen to view all current machine settings on the same screen and to quickly make changes to any of the settings. If no buttons are pressed within 10 seconds the Settings Screen will revert to the Stringing Screen.



Stringing Screen

The Stringing Screen displays the tension settings for the main strings and cross strings. The large tension value on the display and the highlighted Main String or Cross String Icon will be the active tension setting. The machine only pulls tension when the Stringing Screen is displayed.

MACHINE FUNCTIONS



Setting Tension

To change the Tension Setting press F2 to increase the Tension Setting in the tens place, F3 to increase the Tension Setting in the units place and F4 to increase the Tension Setting in the tenths place. To decrease the Tension Setting press F6 to decrease the Tension Setting in the tens place, F7 to decrease the Tension Setting in the units place and F8 to decrease the Tension Setting in the tenths place.

NOTE: Continuing to press the buttons for the lower place values will increase or decrease the higher place values.



Setting LBS-KGS

To select LBS (pounds) or KG (kilograms), pressing the LBS-KG Button will toggle back and forth between LBS and KG. The tension setting can be switched between LBS and KG at any time and the tension setting will be displayed accordingly.



Setting Different Tensions for Main Strings and Cross Strings

To preset Tension Settings for the Main Strings and Cross Strings, press the MAIN/CROSS String Button to toggle between the Main String and Cross String tension settings.

To set the tension value for the Main Strings, press the MAIN/CROSS String Button and

when the Main String Icon on the display is highlighted, set the Main String tension value. To set the tension value for the Cross Strings, press the MAIN/CROSS String Button and when the Cross String Icon on the display is highlighted and set the Cross String tension value. Once the desired Main String and Cross String tension values are entered, to save the settings in the active Memory Setting press the ENTER button.

NOTE: The active tension setting is displayed by the large numbers on the screen for whichever string icon is highlighted on the screen.

MACHINE FUNCTIONS



Permanent Memory Settings

There are 9 permanent Memory Settings that can be used to store 9 combinations of machine settings. Pressing the MEMORY button will scroll through the 9 Memory Settings in increasing order. To reverse the scrolling order, press the F5 button. The Blue LED will illuminate and the scrolling order will be in decreasing order.

For any Memory Setting you can enter a specific Main String Tension, Cross String Tension, Knot String Setting, Pre-stretch Setting and Pulling Speed Setting for a specific application, such as type of string or set-up. Each setting can be entered and saved according to the instructions on the previous and following pages.



Basic Stringing Mode

A Basic Stringing Mode can also be enabled by pressing and holding the Memory Button for 5 seconds. When enabled the Blue LED illuminates next to the Memory Button and an M0 appears on the screen above the Speed Icon.

The M0 Basic Stringing Mode is used when you do not wish to use or alter any of the permanent Memory Settings that were pre-programmed and saved for specific applications. Settings are not permanently saved when in the M0 Basic Stringing Mode. When the machine is turned off all settings will revert back to the default settings when the machine is turned back on.

To change back to the Permanent Memory Setting Mode, press and hold the Memory Button for 5 seconds until the Blue LED goes out and one of the 9 permanent Memory Settings appears above the Speed Icon.

MACHINE FUNCTIONS



Setting the Pulling Speed from the Stringing Screen

To change the Pulling Speed Setting while in the Stringing Screen, first press the PULLING SPEED button to display the Pulling Speed Icon and Pulling Speed Setting on the display. Then press and hold the PULLING SPEED button again until the Pulling Speed Setting is highlighted above

the Pulling Speed Icon. Press any of the F2, F3 or F4 buttons to increase the Pulling Speed Setting in 10% increments and any of the F6, F7 or F8 buttons to decrease Pulling Speed Setting in 10% increments. When the desired Pulling Speed Setting is displayed, press the ENTER button to save the Pulling Speed Setting for the active Memory Setting.

NOTE: Selectable Pulling Speeds range from 30% (Slowest Pulling Speed) to 100% (Fastest Pulling Speed) in 10% increments.



Setting the Pulling Speed from the Settings Screen

To change the Pulling Speed Setting from the Settings Screen, first press F1 to display the Settings Screen. After the Settings Screen appears on the display, press the PULLING SPEED button to highlight the Pulling Speed Setting above the Pulling Speed Icon. Press any of the F2, F3 or F4 buttons to increase the Pulling Speed Setting in 10% increments

and any of the F6, F7 or F8 buttons to decrease Pulling Speed Setting in 10% increments. After the desired Pulling Speed Setting is entered press the ENTER button to accept and save the Pulling Speed Setting for the active Memory Setting. If no other buttons are pressed within 10 seconds the display will return to the Stringing Screen. Pressing the ESC or RETURN button will immediately return to the Stringing Screen.

NOTE: The slowest pulling speed should always be used when stringing very stiff strings, such as aramid fiber strings. Stringing at slower pulling speeds will help to reduce tension loss over time for any string types, especially for strings that tend to lose tension more quickly than others.

MACHINE FUNCTIONS



Pre-stretch Function

The Pre-stretch function is used to pre-stretch strings by increasing the applied tension by a set percentage over the tension setting before releasing the string and re-pulling to the desired tension. This function helps to reduce the amount of tension loss in the strings over time.

Pressing the PRE-STRETCH button will toggle the Pre-stretch function on and off and display the Pre-stretch Icon and Pre-Stretch Setting. When the Pre-Stretch function is enabled, a small Pre-stretch Icon will appear on the Stringing Screen below the Tens digit of the tension setting. When the Pre-stretch function is disabled, or when the pre-stretch setting is 0%, the Pre-stretch Icon will not be visible on the Stringing Screen.



Setting the Pre-Stretch from the Stringing Screen

To change the Pre-stretch Setting while in the Stringing Screen, press the PRE-STRETCH button once and while the Pre-stretch Icon is visible on the display, press and hold the PRE-STRETCH button again until the Pre-stretch Setting is highlighted. Press any of

the F2, F3 or F4 keys to increase the Pre-stretch Setting in 1% increments and any of the F6, F7 or F8 keys to decrease the Pre-stretch Setting in 1% increments. When the desired Pre-stretch Setting is displayed, press ENTER to save the Pre-stretch Setting for the active Memory Setting.

NOTE: Selectable Pre-stretch Settings range from 0% to 30% in 1% increments.



Setting the Pre-stretch from the Settings Screen

To change the Pre-stretch Setting from the Settings Screen, press F1 to display the Settings Screen. After the Settings Screen appears on the display, press the PRE-STRETCH button to highlight the Pre-stretch Setting above the Pre-stretch Icon. Press any

of the F2, F3 or F4 keys to increase the Pre-stretch Setting in 1% increments and any of the F6, F7 or F8 keys to decrease the Pre-stretch Setting in 1% increments. When the desired Pre-stretch Setting is displayed, press ENTER to accept and save the Pre-stretch Setting for the active Memory Setting. If no other buttons are pressed within 10 seconds the display will return to the Stringing Screen. Pressing the ESC or RETURN button will immediately return to the Stringing Screen.

MACHINE FUNCTIONS



Knot String Function

The Knot String function is used to increase the applied tension by a set percentage over the tension setting on the last main string or cross string pulled before tying off. This function helps to compensate for tension loss caused by the slack portion of the string from the string clamp to the tie-off knot.

Pressing the KNOT button will toggle the Knot function on and off. When the Knot function is enabled, the Knot Icon will appear on the Stringing Screen and the Blue LED will illuminate next to the KNOT button. The function will be enabled for the next pull and then will automatically disable itself.



Setting the Knot Tension from the Stringing Screen

To change the Knot Setting while in the Stringing Screen, press the KNOT button once and while the Knot Icon is visible on the display, press and hold the Knot button again until the Knot Setting is highlighted above the Knot Icon. Press any of the F2, F3 or F4 keys to increase the Knot Setting

in 1% increments and any of the F6, F7 or F8 keys to decrease the Knot Setting in 1% increments. When the desired Knot Setting is displayed, press ENTER to save the Knot Setting for the active Memory Setting.

NOTE: Selectable Knot Settings range from 0% to 30% in 1% increments.



Setting the Knot Tension from the Setting Screen

To change the Knot Setting from the Settings Screen, press F1 to display the Settings Screen. After the Settings Screen appears on the display, press the KNOT button to highlight the Knot Setting above the Knot Icon. Press any of the F2, F3 or F4 keys to increase the Knot Setting in 1% increments

and any of the F6, F7 or F8 keys to decrease the Knot Setting in 1% increments. When the desired Knot Setting is displayed, press ENTER to accept and save the Knot Setting for the active Memory Setting. If no other buttons are pressed within 10 seconds the display will return to the Stringing Screen. Pressing the ESC or RETURN button will immediately return to the Stringing Screen.

STRING GRIPPER OPERATION

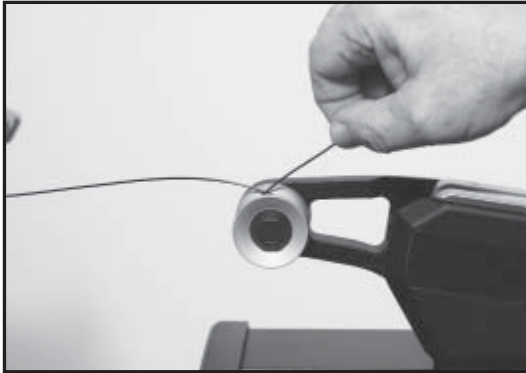

String Gripper Operation

To insert a string into the Quick Closing linear string gripper, wrap the string clockwise around the string guide and insert the string between the string gripper plates. Excessive slack in the string should be removed before applying tension. **Pull the string perpendicular to the gripper plates while pressing the tension lever located at the rear of the gripper.** As tension is applied, the gripper jaws will engage to hold the string. To release tension on the string depress the tension lever switch or use the foot pedal switch.

For adjustment of the parallel plates, see "Setting the Gripper Plate Spacing" on page 22.

CAUTION: NEVER TENSION A STRING WITH YOUR FINGERS BETWEEN THE STRING AND THE STRING GUIDE AS SERIOUS INJURY COULD RESULT IF YOUR FINGER IS CAUGHT BETWEEN THE STRING AND STRING GUIDE DURING TENSIONING. PUSH ANY BUTTON TO RELEASE TENSION.

MOUNTING THE FRAME



Adjusting the Frame Mounting Stands

To adjust the spacing between the Mounting Stands, turn one of the knobs located at either end of the Turntable. There is an arrow on the face of each knob indicating the turning direction that will “Tighten” the mounting points and move the Mounting Stands further apart to bring the posts of the Frame Support Slides closer to the inside surface of the racquet head. Turning the knobs in the opposite direction will move the Mounting Stands closer together. When

mounting a racquet, adjust the Mounting Stand spacing until the posts of the Frame Support Slides fit inside the head of the racquet. Lower the racquet over the posts and adjust the mounting stands until the posts just make contact with the inside surface of the racquet head at its center points located at 6 and 12 o’clock.

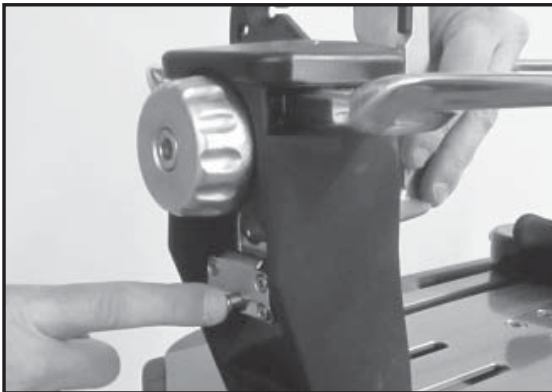

Adjusting the Frame Support Slide

Center the racquet over the Mounting Stands. To adjust the distance from the inside of the mounting stand and the frame support, press the quick release button on the back side of the Mounting Stand, located below the Shoulder Support Knob, and lock the Frame Support Slide into one of the three positions depending on the shape and head size of the racquet. Check to make sure the quick release lock is fully seated in the groove on the Frame Support hex shaft.

Tighten the Frame Supports on the racquet by turning the Mounting Stand Adjustment Knob at either end of the Turntable until they are snug.

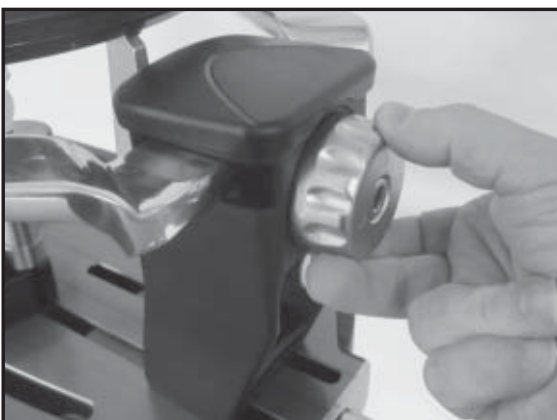

Securing the Shoulder Supports

To secure the racquet frame with the Shoulder Supports, rotate the large Adjustment Knobs on the outside of the Mounting Stands clockwise to bring the mounting arms together. Adjust until firm contact is made between the Shoulder Supports and the frame. Re-adjust the stand position as needed to ensure that the Frame Supports are in firm contact with the racquet at 6 and 12 o’clock. Do not over tighten any of the supports as racquet deformation may occur. The supports should be

tightened to the point where the racquet frame will not move in the Mounting System when the handle is grasped and attempts are made to move it. Should any supports lose contact with the frame while stringing, they should be re-tightened.

MOUNTING THE FRAME



Frame Shoulder Support Adjustment

The shoulder supports are designed to rotate and can be adjusted to provide maximum support to the racquet frame. Rotate the support so that the pads contact the frame squarely when the arms are closed against the racquet. Should the shoulder supports block string holes, adjust the frame support slides to re-position the racquet between the arms so the shoulder supports make contact with the racquet between grommet holes.



Badminton Shoulder Support Cover

When stringing badminton racquets, slide the Badminton Shoulder Support Cover over the Shoulder Supports. There is no need to remove the Tennis Shoulder Supports.

Note: Special three finger Badminton Frame Supports for the head and throat of the racquet are also available as an optional accessory to reduced the pressure between the frame support and badminton frame as strings are installed under tension.

STRING CLAMP OPERATION

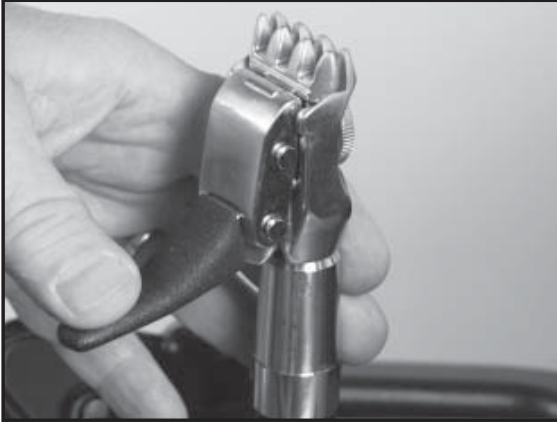

String Clamp Operation

The String Clamps are a dual action design where the String Clamp and Clamp Base operate independently of one another.

To clamp a string, lift the String Clamp and place the string between the jaws and depress the String Clamp Lever to secure the string. The clamping pressure applied to the string should be adjusted to provide sufficient pressure to secure the string when subjected to the desired pulling tension. The textured surface of the teeth provide for increased friction between the clamps and the string to allow for reduced

clamping pressure while securing and holding the string under tension.

Note that excessive pressure can damage both the strings and String Clamp.

AUTO-RELEASE BASE OPERATION



Clamp Base Operation

To lock the Clamp Base to the Turntable, rotate the Clamp Base locking lever clockwise until it locks into place. Note that to lock the clamp base lever, the string clamp must be lifted up to disengage the release mechanism located at the base of the tube.

To release the Clamp Base from the Turntable, lower the string clamp into the tube to engage the release mechanism, or press the rocker lever on the top of the clamp base lever.

To adjust the Clamp Base refer to page 30.

STRINGING THE FRAME

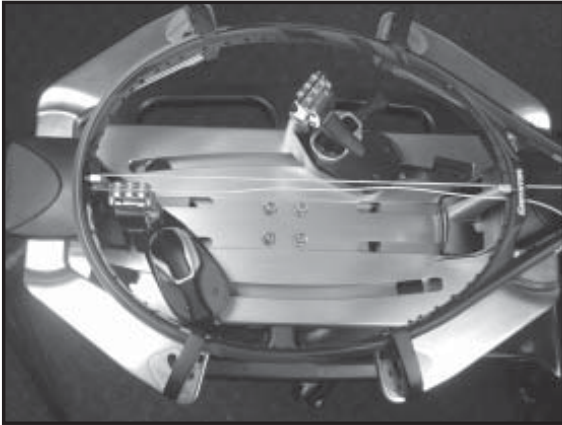

Stringing the Mains

Follow the manufacturer's recommended stringing pattern for one or two piece stringing.

To determine which end of the racquet to start installing the string count the number of grommet holes located in the throat bridge. If there are 2 or 6 holes start main strings at the center 2 holes of the throat bridge. If there are 4 or 8 holes start the main strings at the center 2 holes at the tip of the racquet.

To begin stringing the main strings, thread the two ends of the string through the two center holes at the appropriate end of the frame and continue through the opposite center holes. Thread one end of the string through the adjacent grommet hole and pull excess by hand. Secure one of the strings using a string clamp.

To begin stringing the main strings, thread the



Pulling Tension

Remove excessive slack in the string before applying tension. To apply tension to the main string, wrap the string clockwise around the String Guide to ensure that the proper tension will be applied to the string.



Insert the string between the Auto-Start Gripper Plates and apply tension to the string. Pull the string towards you at a slight angle to engage the sensor in the front of the gripper to automatically tension the string. As the gripper plates slide to the left, they close and will grip the string. The Gripper will move to the right, away from the racquet, and gradually apply tension to the string. To release the tension on the string depress the tension release lever at the rear of the gripper or use the Foot Pedal switch.

For adjustment of the parallel plates, see "Setting the Gripper Plate Spacing" on page 27.

CAUTION: NEVER TENSION A STRING WITH YOUR FINGERS BETWEEN THE STRING AND THE STRING GUIDE AS SERIOUS INJURY COULD RESULT IF YOUR FINGER IS CAUGHT BETWEEN THE STRING AND STRING GUIDE DURING TENSIONING. PUSH ANY BUTTON TO RELEASE TENSION.

STRINGING THE FRAME



Tension Indicator LEDs

As tension is applied to the string, the 4 Tension Indicator LEDs on the Control Panel will progressively flash until all 4 are lit indicating that the set tension has been reached. The 4 LEDs will remain lit and the Gripper will continue to pull to maintain the set tension in the string until the string is clamped off and the tension is released.

To release the string after clamping, press the Tension Lever Switch or Foot Pedal Switch. If the String Gripper does not release the string, push the gripper plates to the right to help disengage and release the string from the Gripper Plates

NOTE: The tensioner has a built in safety that will shut down the motor if a string is not released within 60 seconds from the time the tensioner is activated. After 30 seconds, an alarm will sound and a 30 second count-down will begin on the display. An alarm will sound again at 20 seconds and at every second from 10 until zero. After 60 seconds, the motor will stop pulling, the alarm will sound in a series of beeps and the 4 Tension Indicator LEDs will begin to flash until the string is released. To release the string, press the Tension Lever Switch or Foot Pedal Switch. Note that after the motor is shut down, the set tension in the string will no longer be maintained.

STRINGING THE FRAME

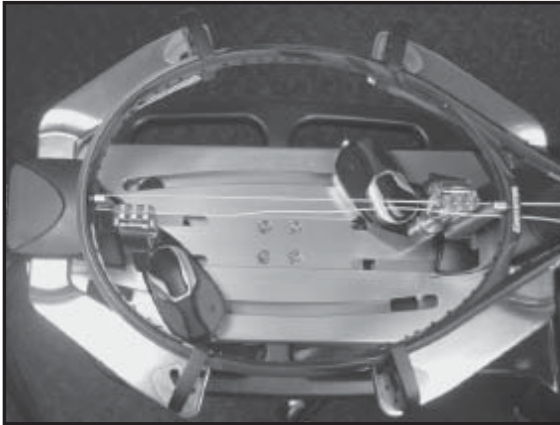

Clamping the First Main String

Secure the tensioned main string using the remaining fixed clamp. Repeat the procedure for all of the remaining main strings and tie off at the appropriate holes following the racquet manufacturers specifications.

This will determine the starting point for the cross strings. If applicable, tie the first cross string using an appropriate starting knot.



Weaving the Cross Strings

Weave the cross strings over and under the main strings being careful to alternate the weave of each consecutive cross string to be opposite of the previously installed cross string.

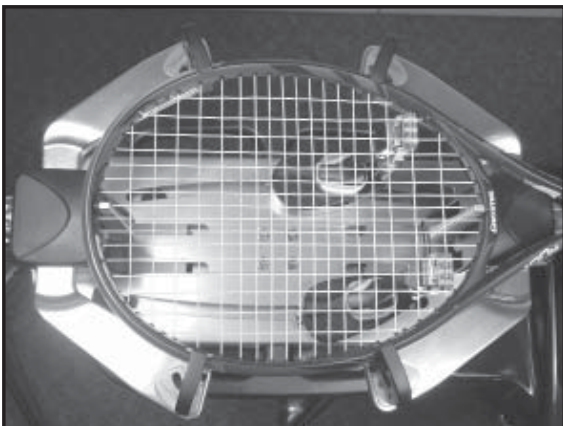

Completing the String Job

Once the final cross string is tensioned and clamped, tie off at the appropriate hole specified by the racquet manufacturer. Remove the frame from the Mounting System by loosening the Shoulder Supports and Frame Supports.

STRING LENGTH METER OPERATION



String Length Meter

Press the String Length Meter (SLM) button to enable the SLM function and display the SLM screen. To change the measurement units from Feet (FT) and meters (M) press the SLM button to toggle between FT and M.

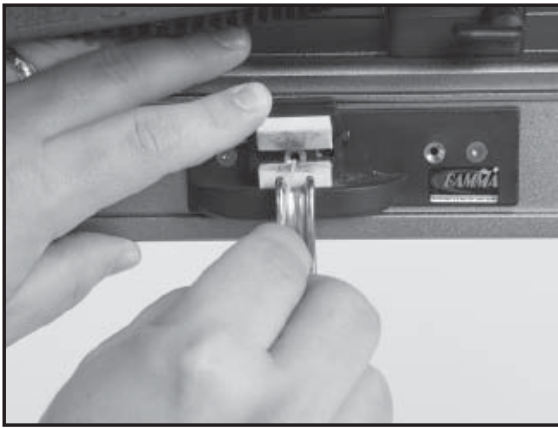

To measure a length of string from a reel or set of string, insert the end of the string through the loop from the backside of the string guide attached to the front of the SLM. Lift the clamp pad and insert the string through the entry hole on the face plate of the SLM. Continue to feed the string into the entry hole until it exits the SLM through the hole on the right side and release the clamp pad. (In addition to aligning the strings with the entry to the SLM, the felt clamp pads apply a slight amount of pressure to the string and wipe down the surface of the string to prevent debris from entering the SLM).

NOTE: When measuring thin strings such as badminton strings, apply light finger pressure to the clamp pad to provide some back pressure while pulling the string through the meter to prevent slipping and obtain more accurate measurements.



When the end of the string exits through the hole on the right, press the ENTER button to “Zero” the String Length Meter, and the length of string will be measured from the point on the string located at the edge of the exit hole. Pull the end of the string at a slow steady rate and the SLM will begin measuring the length of string as it is pulled through the SLM and indicate the measurement on the display. When the desired length of string is measured, cut the string at the edge of the exit hole.

NOTE: When reaching the end of a string, pull the string through the SLM slowly to avoid inaccurate measurement.

The measurement accuracy of the SLM is approximately +/- 0.5% of the indicated value for thicker strings when the tension is set for 35 lbs and higher and badminton strings when the tension is set for under 35 lbs prior to measurement.

ADDITIONAL FEATURES



Turntable Brake

The Turntable may be locked in any position.

To lock the Turntable Brake pull the brake lock pin OUT.

To release the Turntable Brake push the brake lock pin IN.



Storage Drawers

There are two Storage Drawers located in the base of the machine. The drawers open from the right side of the base and lock into the end cap with a spring loaded latch.

To open the drawers depress that latch in the face of the drawer and slide them out to the right. To close the drawers simply slide the drawers back inside the base and the latch with automatically lock into place.



Turntable Clutch

To adjust the free rotation of the turntable, turn the Turntable Clutch bolt located on the left end of the base clockwise to add friction and restrict rotation or turn the Turntable Clutch bolt counter-clockwise to reduce the friction and allow the turntable to rotate more freely.

PATHFINDER AWL

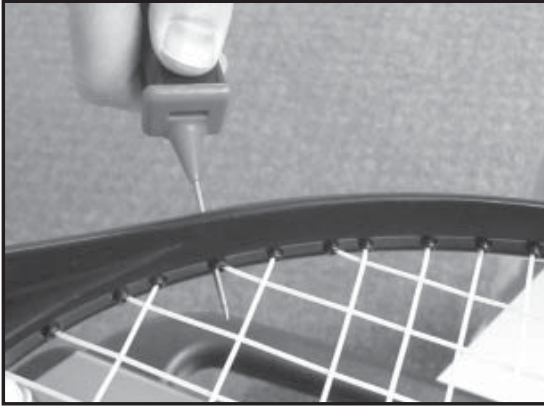

The machine includes the Pathfinder Stringing Awl which creates a pathway between or around strings to make inserting a string through blocked grommets easier and quicker.

Insert the awl through the grommet hole in the same manner as for traditional awls. The Pathfinder Awl must be in the closed position before insertion.

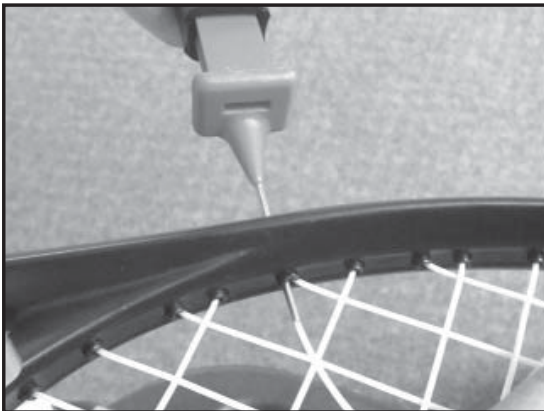

Once the awl is inserted, pull the handle of the awl outward while holding the tip section in place. This leaves the outer sheath in the grommet hole. Insert the end of the string into the outer sheath.

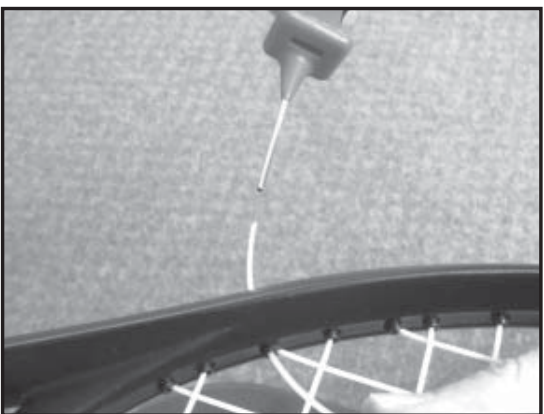

While holding the string, slowly pull the sheath out of the grommet hole to leave the free end of the string exposed.

MAINTENANCE & ADJUSTMENTS



Tension Calibration Procedure

During power up press both ESC and ENTER buttons to enable the calibration mode.

The display will show 22 lbs or 10 kgs. KG/LBS can be changed at any time by pressing the LB/KG Button.

Using a Tension Calibrator, apply tension to the calibrator and adjust the value on the display up or down to match the reading on

the calibrator. Press the ENTER button to confirm and release the tension on the calibrator.

When the Gripper returns to the home position the display will now show 44 lbs or 20 kgs. Apply tension to the calibrator and adjust the value on the display up or down to match the reading on the calibrator. Press the ENTER button to confirm and release the tension on the calibrator.

When the Gripper returns to the home position the display will now show 66 lbs or 30 kgs. Apply tension to the calibrator and adjust the value on the display up or down to match the reading on the calibrator. Press the ENTER button to confirm and release the tension on the calibrator.

When the Gripper returns to the home position the display will now show 88 lbs or 40 kgs. Apply tension to the calibrator and adjust the value on the display up or down to match the reading on the calibrator. Press the ENTER button to confirm and release the tension on the calibrator. The Calibration procedure is now complete.

NOTE: If ESC is pressed at any time during calibration, the calibration procedure will be terminated and no new calibration data will be saved.

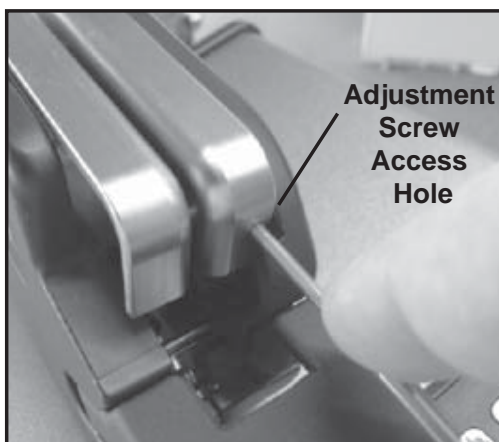

Gripper Plate Spacing Adjustment

The Gripper Plates of the String Gripper are adjustable to accommodate various string gauges and types of string. If the string slips through the Gripper Plates while pulling tension, insert a 2.5mm hex wrench through the access hole on the back of the right Gripper Plate and into the Adjustment Screw. Turn the Adjustment Screw clockwise to increase the compression on the string. If too much pressure is applied to the string while pulling tension, rotate the Gripper Adjustment Screw counter-clockwise to reduce the compression on the string. The Gripper Plates are properly adjusted when there is enough pressure to securely hold the string without slipping and without excessively compressing the string.

TIP: If you turn off the machine with the Gripper located at the far right side of the track, it is easier to access the Adjustment Screw.

MAINTENANCE & ADJUSTMENTS

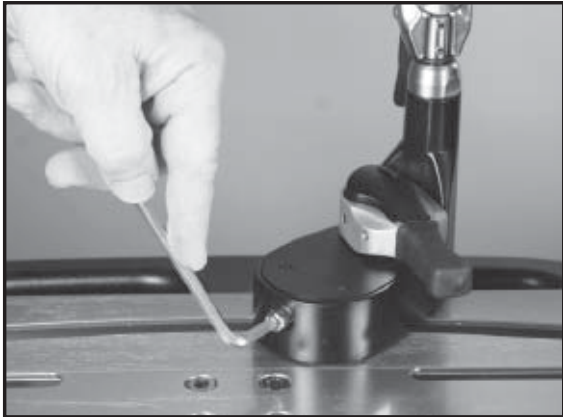

Auto-Release Clamp Base Adjustment

If the Clamp Bases slip on the Turntable, the base locking levers may need adjusted. Turn the cap screw located on the end of the Clamp Base clockwise to increase clamping pressure and counterclockwise to reduce it. If frequent adjustment is needed, try loosening the Locking Lever Adjustment Screw and tighten the two screws located on the underside of the Clamp Base. Re-tighten the Locking Lever Adjustment Screw and adjust as needed.



Clamp Base Removal

Clamp Bases can be removed from the Turntable for maintenance or cleaning by removing the Clamp Stop located at the end of the slot in the Turntable. To remove the Clamp Stop, remove the two screws holding the Clamp Stop in place from the underside of the Turntable. Lift the Clamp Stop out of the slot, slide the Clamp Base to the end of the slot and lift it out. Replace the Clamp Base and clamp stop in reverse order.

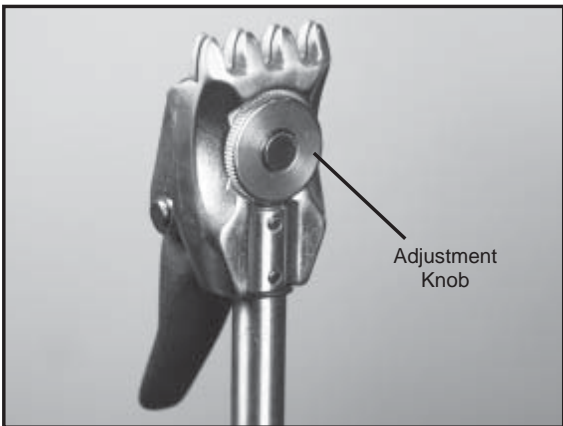

Adjusting String Clamp Jaw Spacing

The String Clamps will need minor adjustments according to what string type, construction, and gauge you are using. To adjust the gap (clamping pressure) between the clamp jaws, insert the string through the racquet as if you were beginning the main strings. Clamp the strings and pull tension. If the string slips through the jaws of the clamp, tighten the clamp by turning the Adjustment Knob, in the clockwise direction. If the clamp leaves impressions in the string, it may be excessively tight and should be adjusted by

turning the Adjustment Knob counter clockwise to increase the gap between the jaws.

NOTE: Due to the bearings used in the clamp lever the action of the clamp lever is very light making it easy to apply excessive clamping pressure. Clamps that are set too tight can damage the string as well as the string clamp jaws.

The clamp jaws should be cleaned periodically to be free from dirt, oil, and any residual string coating for them to grip properly. The cleaning stone supplied with the machine is excellent for removing build-up on the diamond coated surfaces. Rub the gripping surfaces with the cleaning stone and remove any residual dust with a brush or cloth and isopropyl alcohol.

TROUBLESHOOTING TIPS

<u>PROBLEM</u>	<u>SOLUTION</u>
String slips in clamps	<ul style="list-style-type: none">- Adjust gap between clamp jaws- Clean clamp jaws
String slips in gripper	<ul style="list-style-type: none">- Adjust gripper jaw stop screw- Clean gripper jaws
String clamp base slips on turntable	<ul style="list-style-type: none">- Clean bottom of clamp & top of turntable with alcohol- Adjust clamp base locking nut
String tension too tight or too loose	<ul style="list-style-type: none">- Check tension using a tension calibrator, adjust machine calibration if necessary
Electrical system does not function	<ul style="list-style-type: none">- Check power source- Check power cord connections

CARE & CLEANING

With time and use, the clamping surfaces of your machine may become oily or dirty and result in string or clamp slippage while stringing. Periodic cleaning of the String Clamps, String Clamp Base and String Gripper is recommended. The supplied Cleaning Stone or a knife sharpening stone works well for cleaning the diamond coated string clamping surfaces. Cleaning with a solvent such as isopropyl alcohol and a mild abrasive tool such as a toothbrush also works well to remove oily or greasy build up.

PARTS SUMMARY

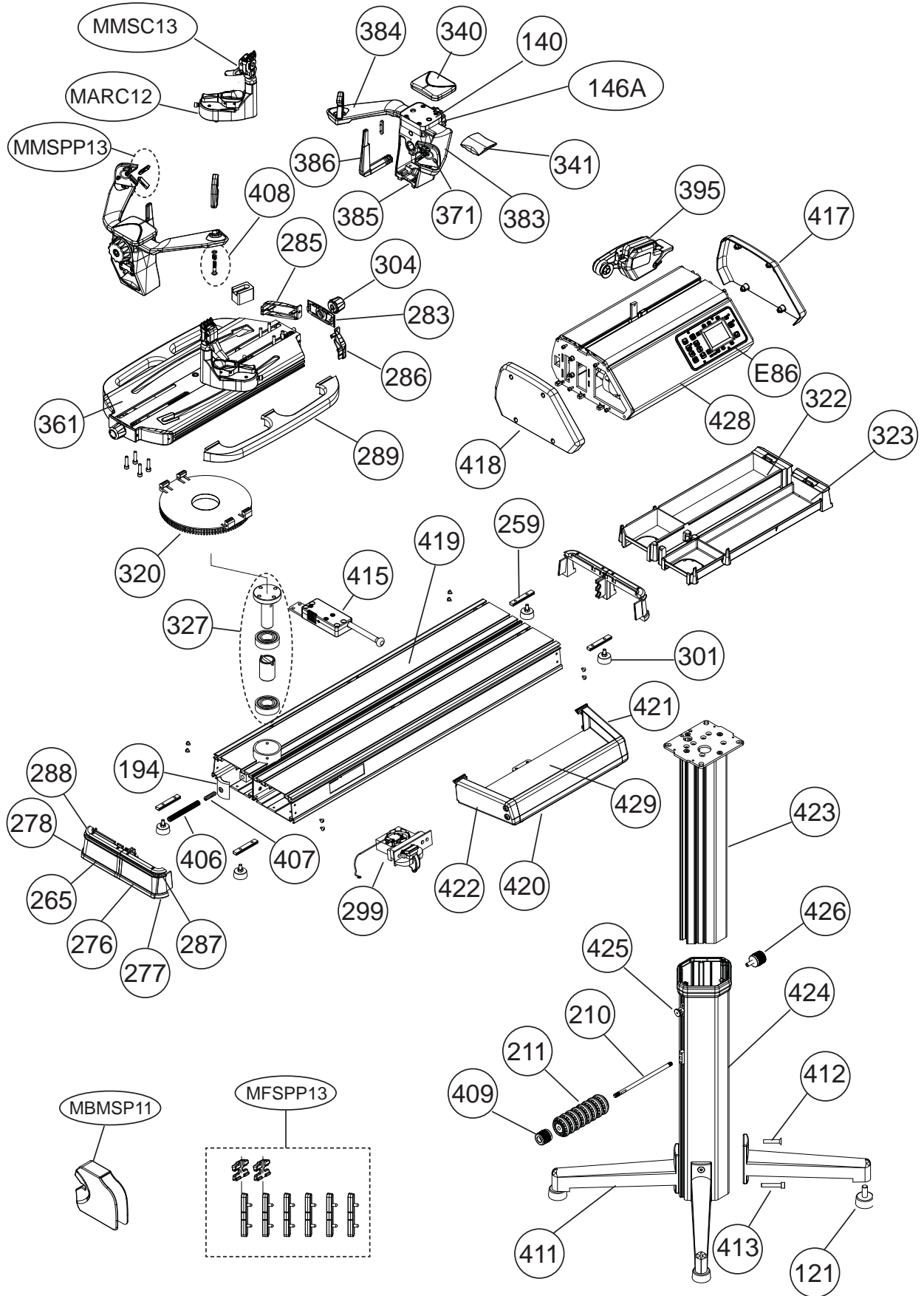

NOTES

NOTES



MMAN-54
(MG89E-10)

GAMMA SPORTS

200 Waterfront Drive
Pittsburgh, Pennsylvania 15222
Phone: 800.333.0337 Fax: 412.323.0317
Visit our website at www.gammasports.com