

GAMMA®

6900 EIs **STRINGING MACHINE** **2 POINT SC MOUNTING**



OWNER'S MANUAL
Issue 4B - February 2014



6900 EIs

OWNER'S MANUAL

TABLE OF CONTENTS

WARRANTY	PAGE 3
FEATURES.....	PAGE 4
UNPACKING & ASSEMBLY INSTRUCTIONS	PAGE 5
POWER CONNECTION & CONTROLS	PAGE 10
MOUNTING THE FRAME	PAGE 12
STRINGING THE FRAME.....	PAGE 13
ADDITIONAL FEATURES	PAGE 16
STRING LENGTH METER.....	PAGE 17
PATHFINDER AWL.....	PAGE 18
MAINTENANCE & ADJUSTMENTS	PAGE 19
TROUBLESHOOTING TIPS	PAGE 21
PARTS LIST	PAGE 22
PARTS DRAWING.....	PAGE 23

LIMITED WARRANTY

GAMMA Sports (GAMMA) warrants to the original purchaser that the 6900 EIs stringing machine ("EQUIPMENT") purchased is free from defects in materials and workmanship for a period of five (5) years from the date of original purchase for mechanical parts and for a period of one (1) year from the date of purchase for all electrical parts and string clamps. Should any defects develop under normal use within the specified time periods, GAMMA will at its option, repair or replace the defective EQUIPMENT provided it is returned to GAMMA prepaid at the purchaser's expense. This warranty does not apply to any damage or defect caused by negligence, abuse, misuse, unauthorized alteration, shipping, handling, or part wear and tear as a result of normal use.

Routine maintenance, adjustment, and cleaning required to ensure proper operation are the responsibility of the purchaser and are not covered under the terms of this warranty. These include, but are not limited to: String Clamp adjustment, as described on page 20, Quick Action Clamp Base adjustment, as described on page 20 and the cleaning procedures listed on page 21.

GAMMA's obligation under this warranty is limited to repair or replacement of defective EQUIPMENT, and no one is authorized to promise any other liability. GAMMA shall in no event be liable for any incidental or consequential damages.

To return defective EQUIPMENT, a return authorization (RA#) must be obtained from a GAMMA customer service representative. The RA# must be marked on the outside of the shipping carton being returned. All returns must be shipped prepaid by the customer to GAMMA. Please retain the original shipping carton and packing materials for any future shipments. GAMMA will not be responsible for machines which are not sent in the original undamaged packaging.

A GAMMA Care Service Plan is also available through GAMMA customer service, call 800.333.0337 for details.

FEATURES



MACHINE FEATURES

- ❖ Electronic Constant Pull Tensioner with 11.0 to 90.0 lbs Tension Range
- ❖ Digital Tension Setting with LED Display
- ❖ Professional Self-Centering Two Point Racquet Mounting System- Accommodates All Racquets
- ❖ Parallel Jaw Rotating Gripper with Diamond Dust Coated Gripping Surfaces
- ❖ Professional “Quick Action” Dual Action, Rotating, Metal Fixed String Clamps with Diamond Dust Coating
- ❖ Fiberglass Cover with Convenient Padded Tool Tray enclosing a High Strength Aluminum Frame
- ❖ Convenient Foot Actuated Tensioner Switch



6900 Eis

Unpacking Instructions & Contents

Instructions for Unpacking and Preparing for Assembly

The stringing machine is shipped in three cartons, a large master carton for the stringing machine base with tensioner module and accessories, a medium carton for the turntable and mounting system and a smaller carton for the floor stand post and base legs. Please save the cartons and packing materials for possible shipments in the future. Gamma Sports cannot be responsible for machines that are not returned, shipped in their original, undamaged packaging. The tools you will need to assemble the machine are provided with the machine. Due to the weight of the tensioner unit, you may need the assistance of someone to help lift the tensioner unit out of the carton.

Once the cartons are opened, remove all inner cartons and check to be sure that all parts are present and accounted for.

Contents of Floor Stand Carton (MMU2-16)

- (1) Lower Column
- (1) Upper Column with Flange Plate
- (4) Legs
- (1) Locking Knob Screw
- (4) M8 x 25 Flat Head Screws
- (4) M8 x 30 Cap Screws
- (8) M8 Nuts
- (1) 12mm Wrench
- (4) M6 x 20 Cap Screws
- (1) M8 x 25 Cap Screws for Height Adjustment
- (1) String Reel Holder (M8 Threaded Pin), (1) Knob, (10) Spacers, & (2) M8 Washers

Contents of Mounting System Carton (MMU2-67)

- (1) Turntable Assembly w/String Clamp Bases and Mounting Stands
- (2) String Clamps
- (1) 17mm Socket

Contents of Large Master Carton (MMU2-12)

- (1) Stringing Machine Base w/ Tensioner Module
- (1) Power Cord
- (1) Foot Pedal Tensioner Switch
- (1) Tool Kit (contains side cutter, bent nose pliers, needle nose pliers, starting clamp)
- (1) Straight Stringers Awl & (1) Pathfinder Specialty Awl
- (1) Tools for assembly and maintenance

ASSEMBLY INSTRUCTIONS

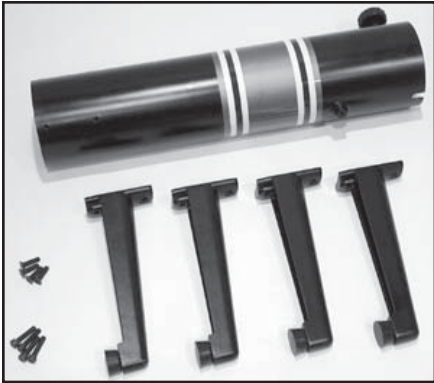

Floor Stand Assembly

The stringing machine uses a four leg floor stand design. The legs must be assembled to the lower column before use. Remove all parts from the shipping carton to confirm that contents match the list of parts on Page 5.



Floor Stand Leg Assembly

Align the holes in the leg flange with the matching holes in the lower column. Secure the leg with one M8 FLAT HEAD screw through the upper hole, and one M8 SOCKET HEAD cap screw through the bottom hole. Install one 8mm nut on each screw. Repeat this procedure for the three remaining legs.



Floor Stand Assembly (Continued.)

To complete the floor stand, screw the height adjustment locking knob ("A") into the side of the lower column. The locking knob should not protrude beyond the inside surface of the lower column at this time.

ASSEMBLY INSTRUCTIONS



Height Adjustment

The height of the machine is adjustable from 39" to 46" in approximate 1" increments. To change the height, remove the socket head cap screw from its current position and place it in the appropriate hole to set the desired height of the machine. Be sure to thread the screw completely into the upper column so the head of the cap screw rests in the notch of the lower column that is parallel to the string reel holder.



Stand Upper Post Installation

With the height adjustment cap screw on the upper column facing the string reel holder, align the four holes in the upper column flange with the threaded holes in the machine base. Lift the machine base and insert the upper post into the lower column until the head of the cap screw rests in the notch of the lower column and tighten the locking knob.

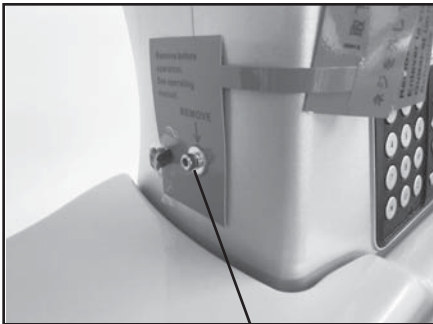

Remove this Screw

Transportation Screw

The machine has been shipped with a motor and load cell protection screw. Remove the screw before using the machine. Retain the screw for future shipment. Install the included rubber grommet into the hole.

ASSEMBLY INSTRUCTIONS

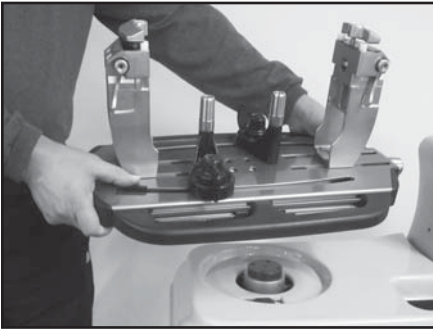

Turntable and Mounting System Installation

To install the turntable position the turntable over the turntable pin and align the bolts, located in the poly bag, with the holes in the flange. Secure them with the included allen wrench.

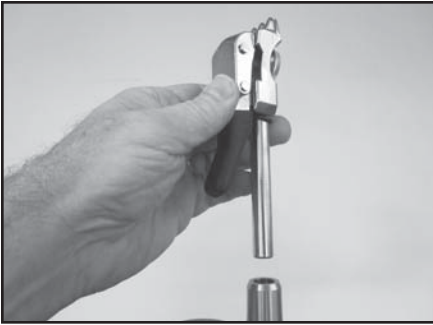

String Clamp Installation

The post of the string clamp and tube of the string clamp base are treated with grease to provide protection against corrosion during shipping. Remove any excessive grease with a clean cloth prior to use. The post and tube may also be cleaned with isopropyl alcohol. After this type of thorough cleaning, the post and tube should be treated with a light coating of machine oil to protect the surfaces against corrosion and to ensure smooth operation.

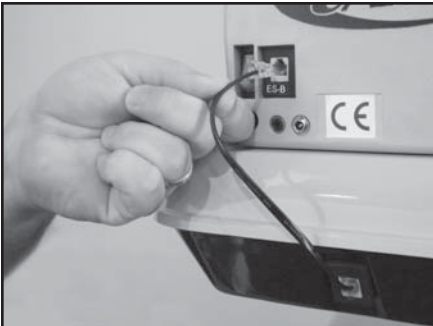

String Length Meter Wire Installation

Connect the black string length meter wire to the receptacle in the black FRP base and to the back of the tensioner.

STRING REEL HOLDER INSTALLATION

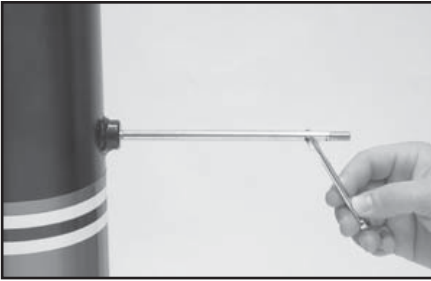

The string reel holder is an 8 mm rod with threads on both ends, and flat surfaces machined on one end. Thread the end of the rod without the flat surfaces into the threaded boss on the side of the lower column. Using the M6 open end wrench positioned on the flat surfaces, securely tighten the rod to the lower column.



The string reel holder can hold up to 5 reels of string (depending on the size of the string reel). Before placing the first reel on the rod, slide two M8 washers over the pin and slide them to the boss on the lower column. After the first reel is placed onto the rod, place two spacers between each reel to provide enough space between reels and allow them to turn freely without rubbing against one another. (To provide a smooth feed to the String Length Meter, place the reels on the rod so the string spools off the reel from the underside of the reel).

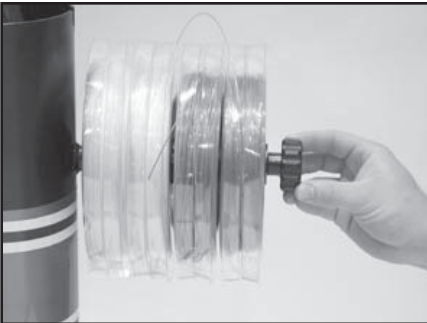

After the last reel is installed, place the remaining spacer(s) on the rod and attach the threaded knob to the end of the rod.

POWER CONNECTION & CONTROLS

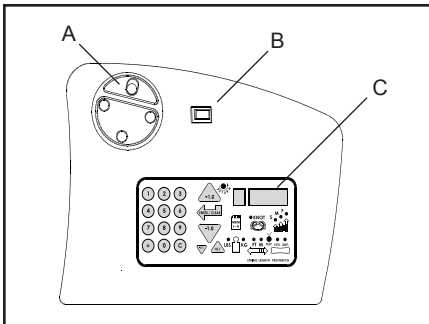

Front Panel Features

- A - String Gripper
- B - Tension Switch
- C - Control Panel

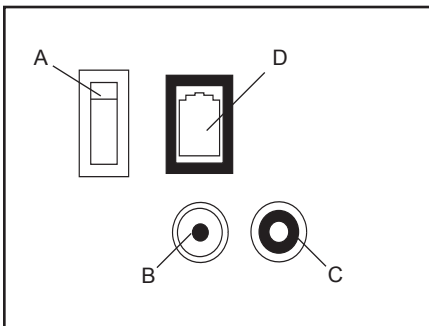

Back Panel Features

- A - Lighted Power Switch
- B - Foot Pedal Switch Receptacle
- C - A/C Power Cord Socket
- D - String Length Meter Socket

Instructions for Power Connection and Controls

CAUTION ! Before connecting to the power supply, check the voltage source that the machine is being connected to. The acceptable range of input voltages for this machine is between 100 V and 240 V @ 50 to 60 Hz. If you have any questions regarding the input voltage supply for your area, please ask your electric utility company.

To install the power cord, insert the female end of the power cord into the AC Adapter and then insert the female end of the cord from the AC Adapter into the A/C Power Cord Socket "C" located on the back panel of the tensioner. Plug the male end of the power cord into a grounded power outlet. When using extension cords, use grounded heavy duty extension cords rated for 15 AMP service.

To connect the foot pedal switch, insert the male pin at the end of the foot pedal switch cord into the Foot Pedal Switch Receptacle "B" located on the back panel of the tensioner.

Switch on the machine by pressing the Lighted On-Off Power Switch on the back panel. At start-up, the LED will display a countdown from "9.0" to "0.0" while the machine performs a self diagnostics check at start-up.

WARNING! FOR INDOOR USE ONLY.
NEVER OPEN UNIT WITH POWER CONNECTED.
CHILDREN SHOULD NEVER BE PERMITTED TO OPERATE THIS MACHINE WITHOUT ADULT SUPERVISION.

CONTROL PANEL FUNCTIONS AND FEATURES

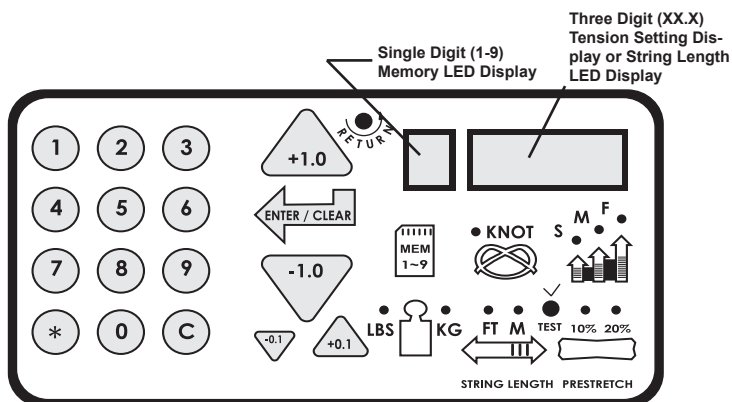

Tension Index Buttons - Changes tension setting in +/- 1.0 or +/- 0.1 Lb or Kg increments. Holding the button down will scroll the tension setting values up or down. Tension settings entered with the tension index buttons are placed into temporary memory setting "0".

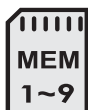

Memory Button - Indexes from 9 preset tension settings that can be stored in memory. Settings are retained even if machine is turned off. Each press of the button indexes to the next memory setting. Memory settings 1-9 must be entered using the keypad followed by pressing the "ENT" button.



Clear Button - Clears display to enter a new tension or to reset String Length Meter measurement.



Enter Button - Saves displayed tension for Memory setting - when tension is entered using the keypad display flashes until this button is pressed to save the setting. Also Clears display for String Length Meter measurements.



Test Button & Racquet Strung - Press once for approximate number of racquets strung. Press again to return. Press and hold for 5 seconds and the machine does an internal diagnostic check, such as the one performed at start-up.



Knot Function - Increases pulling tension by 10% over the setting value (max 90 lbs / 40.8 kgs) for one pull. During the pull the LED stays lit to indicate the Knot function is enabled.



Lbs/Kgs Button - Changes tension display from Lbs to Kgs. Each press of the button toggles back and forth between Lbs and Kgs.



Speed Button - Changes pulling speed of winder from Fast (default) to Medium to Slow. Slow speed is recommended for low stretch strings, such as Kevlar. Each press of the button toggles between Fast, Medium and Slow speeds.



Pre-Stretch Function - Pulls string 10% or 20% over the tension setting (up to 90 lbs / 40.8 kgs), releases the string, and repulls to the tension setting. Each press of the button toggles between 10%, 20% or no pre-stretch.

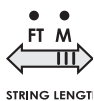

String Length Meter Button- Enables string length meter function. Each press of the button toggles between Meters and Feet. To switch back to tensioning function, press the "Lbs/Kgs" button.

MOUNTING THE FRAME



Adjusting the Inner Racquet Supports

The white racquet supports are adjustable to accommodate all racquets and provide maximum support to the racquet frame. Screw the pads up or down so they contact the frame at a maximum height without blocking the grommet holes.

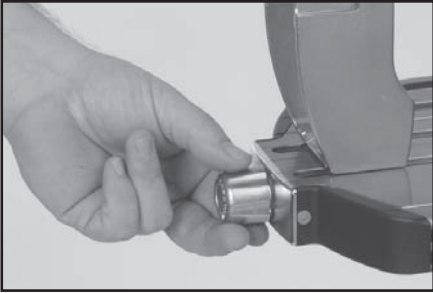

Mounting Stand Adjustment

When mounting a racquet, adjust the Mounting Stands so that the white Racquet Supports on top of the Mounting Stands fit inside the hoop of the racquet. Lower the racquet over the Racquet Supports and adjust the Mounting Stands until the supports just make contact with the inside surface of the racquet at the head and throat. There is an arrow on the face of each knob indicating the turning direction that will "Tighten" the mounting points by moving the 2pt Mounting Stands further apart to bring the

Racquet Supports closer to the inside surface of the racquet at the head and throat. Turning the knobs in the opposite direction will move the Mounting Stands closer together and will allow the Racquet Supports to move away from the racquet frame.

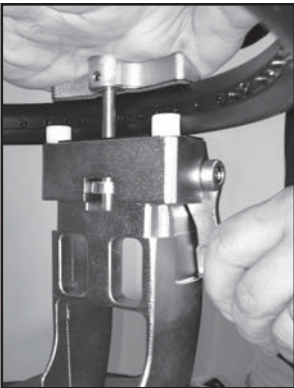

Racquet Hold Down Clamp Operation

With the lever in the up position, insert the racquet hold down clamp pin into the hole in the center of the mounting stand. Lower the hold down clamp until it just makes contact with the surface of the racquet. Using slight palm pressure on the hold down clamp depress the racquet hold down lever completely to secure the racquet frame to the stand.

MOUNTING THE FRAME

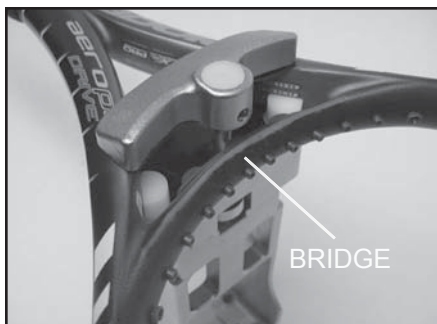

Special Throat Mounting

For racquets with a bridge that is thinner than the rest of the frame or are tapered from head to throat you may need to mount the racquet with the shafts of the racquets supported by the white support pads as pictured.

STRINGING THE FRAME



String Clamp Operation

The string clamps are a dual action design where the string clamp and clamp base operate independently of one another.

To clamp a string, lift the string clamp, place the string between the jaws and depress the string clamp lever to secure the string. The clamping pressure applied to the string should be adjusted to provide sufficient pressure to secure the string when subjected to the desired pulling tension. The diamond coated gripper plates provide for increased friction between the clamps and the string

to allow for reduced clamping pressure while securing and holding the string under tension.

Note that excessive pressure can damage both the strings and String Clamp.



Clamp Base Operation

To lock the string clamp base to the turntable, rotate the clamp base locking lever clockwise.

To release the string clamp base from the turntable, rotate the clamp base locking lever counter-clockwise.

The Locking Lever should be tightened enough to prevent clamp base slippage on the turntable when the desired tension is placed on the string.

STRINGING THE FRAME

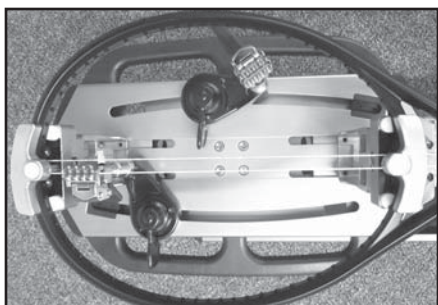

Getting Started

To begin stringing the main strings, thread the two ends of the string through the two center holes at the appropriate end of the frame and continue through the opposite center holes. Thread one end of the string through the adjacent grommet hole and pull excess by hand.

Secure one of the strings using a string clamp.

Handy tip: The tear drop shaped holes towards the back of the shoulder supports are handy for holding the loose end of the string while tensioning the string. Simply insert the loose end into the tear drop shaped holes and slide the string toward the point of the hole.

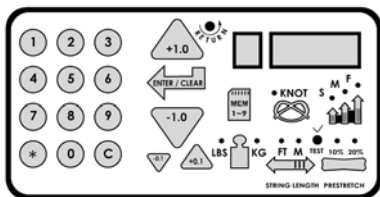

Setting the String Tension

String tensions may be entered and stored into one of nine memory storage settings (See section on Control panel Functions and features) by using the keypad or the tension index buttons. While a tension setting is entered, the value displayed will be temporary until the "Enter" button is pressed to store it in one of the nine permanent memory settings.

Aramid fiber and metallic strings will generally string up tighter on the machine compared to synthetic or natural gut strings. Therefore, when stringing with Aramid (Kevlar, Technora) hybrid strings or metallic strings, we recommend setting tension 4-5 lbs. lower than you would normally use for synthetic or natural gut strings.

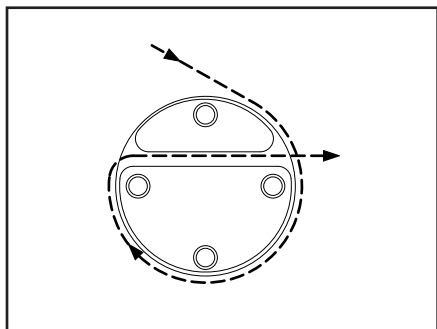

Applying Tension

To apply tension, wrap the string clockwise around the gripper drum and position the string between the gripper jaws.

The string must pass over the upper gripper jaw before being placed between the gripper jaws, as the tension on the string provides the clamping force to the gripper jaws.

Before applying tension, gently pull the string until all slack is removed.

CAUTION: NEVER TENSION A STRING WITH YOUR FINGERS BETWEEN THE STRING AND THE UPPER GRIPPER JAW AS SERIOUS INJURY COULD RESULT IF YOUR FINGER IS CAUGHT BETWEEN THE STRING AND THE UPPER JAW DURING TENSIONING. PUSH GRIPPER REVERSING SWITCH OR ANY BUTTON IN CASE OF EMERGENCY.

STRINGING THE FRAME



To apply tension to a string, push the tension switch or the foot pedal. The string gripper will rotate and slowly apply tension to the string. When the set tension has been attained, the gripper will stop rotating and the display will flash. As the tensioned string stretches, the gripper will continue to pull and rotate intermittently, maintaining the set tension.

To release the string after clamping, push the tension switch or foot pedal. If the string gripper does not release the string, depress and hold the return button to release the string.

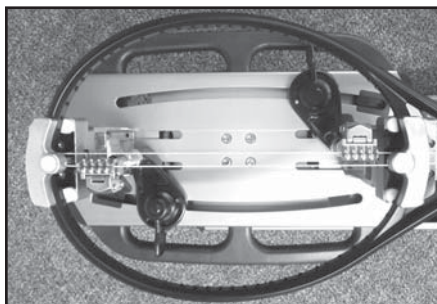

Clamping the First Main String

Secure the tensioned main string using the free fixed clamp. Repeat the procedure for all of the remaining main strings and tie off following the racquet manufacturers recommendations.

Follow the manufacturer's recommended stringing pattern for one or two piece stringing. This will determine the starting point for the cross strings. If applicable, tie the first cross string using an appropriate starting knot.

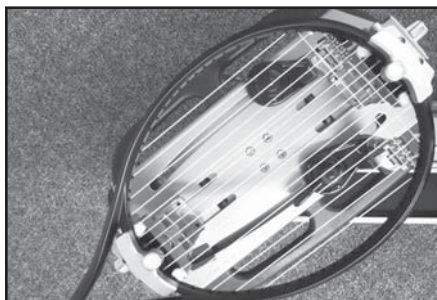

Weaving the Cross Strings

Weave the cross strings over and under the main strings being careful to alternate the weave direction of each consecutive cross string so as to be opposite of the previously installed cross string.

STRINGING THE FRAME

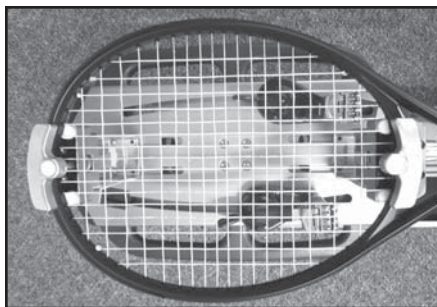

Completing the String Job

Once the final cross string is tensioned and clamped, tie off at the appropriate hole specified by the racquet manufacturer. Remove the frame from the mounting system by releasing the racquet holddowns and loosening the mounting stands.

ADDITIONAL FEATURES



Locking the Turntable

The turntable may be locked in any position.

Rotate the lever down to lock the turntable and up to release the turntable.

STRING LENGTH METER OPERATION

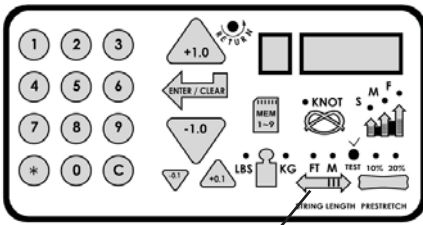

SLM Button

To enable the String Length Meter (SLM) function, press the String Length button on the keypad. When the String Length button is pressed, one of the LED indicators above "M" or "FT" will light up to indicate that the SLM function is enabled. Pressing the String Length button will toggle between "M" and "FT" to set the measurement units for either Meters ("M") or Feet ("FT"). Measurements are displayed in 0.1 increments.



To measure a length of string from a reel or set of string, insert the end of the string through the loop from the backside of the string guide attached to the front of the SLM. Lift the clamp pad and insert the string through the entry hole on the face plate of the SLM. Continue to feed the string into the entry hole until it exits the SLM through the hole on the right side and release the clamp pad. (In addition to aligning the strings with the entry to the SLM, the felt clamp pads apply a slight amount of pressure to the string and wipe down the surface of the string to prevent debris from entering the SLM).



When the end of the string exits through the hole on the right, press the "C" or "Enter/Clear" button on the keypad to "Zero" the display. The length of string will be measured from the free end to the edge of the exit hole. Pull the free end of the string at a slow steady rate and the SLM will begin measuring the length of string as it is pulled through the SLM and indicate the measurement on the LED display. When the desired length of string is measured, cut the string at the edge of the exit hole.

Note: When reaching the end of a string, pull the string through the SLM slowly until it exits the SLM to avoid inaccurate measurement.

The string length meter was designed to measure strings between 1.10 mm (18 ga) and 1.45 mm (15 ga) at an accuracy of $\pm 0.3\%$ of the indicated value and ± 2 inches (50 mm) absolute. When measuring strings smaller than 1.10 mm (such as badminton strings) the error will be -2.5% of the indicated value (up to 6" short in 40 ft) and ± 2 inches (50 mm) absolute.

PATHFINDER AWL

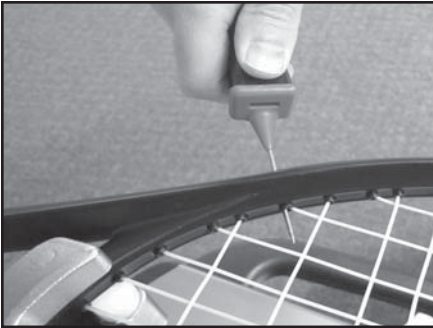

The machine includes the Pathfinder stringing awl which creates a pathway between or around strings to make inserting a string through blocked grommets easier and quicker.

Insert the awl through the grommet hole in the same manner as for traditional awls. The Pathfinder awl must be in the closed position before insertion.

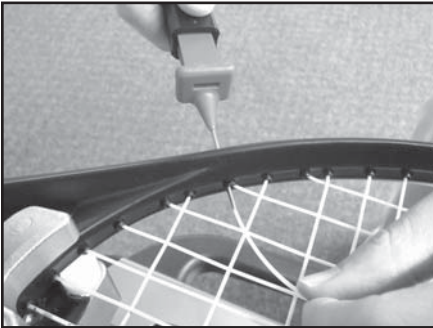

Once the awl is inserted, pull the handle of the awl outward while holding the tip section in place. This leaves the outer sheath in the grommet hole. Insert the end of the string into the outer sheath.

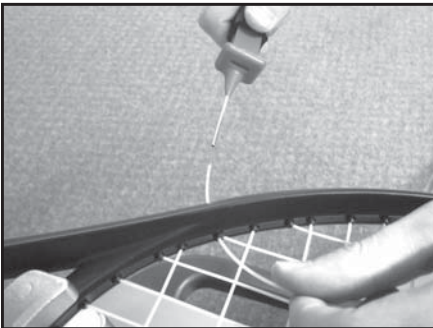

While holding the string, slowly pull the sheath out of the grommet hole to leave the free end of the string exposed.

MAINTENANCE & ADJUSTMENTS

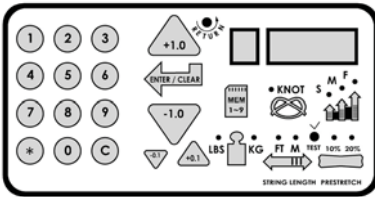

Tension Calibration Procedure

Each stringing machine has been checked and calibrated at the factory using accurate load sensing devices to ensure that the machine pulls at the correct tension. However, if you suspect that your machine may not be pulling at the correct tension you can check the pulling tension with a calibrator and make adjustments if needed.

Most tension calibrators (such as a Gamma Tension Calibrator) function by clamping off the string attached to one the end of the calibrator and applying tension to the string located on the opposite end of the calibrator. The tension measured by the calibrator will then display the tension being applied to the calibrator by the machine. If the calibrator and tensioner do not match then you can adjust the tensioner as follows:

(1) Turn the machine off and restart the machine while holding down the Test button until the count down is complete. 22 lbs should appear on the display. (2) Apply tension to the calibrator. (3) If the tension reading on the calibrator does not match the tension displayed on the machine, use the tension indexing buttons to match the display to the calibrator reading and press the Enter/Clear button (4) Release the tension applied to the calibrator and 44 lbs should appear on the display. (5) Repeat steps #2-#4 for 44, 66 & 88lbs. (6) After completing the adjustment at 88lbs the display will show 00 lbs. (7) Restart the machine without holding any buttons and the calibration adjustment will be complete.

Switching the Buzzer Off and On

The stringing machine is equipped with a buzzer that sounds when any key or button is pressed or when there is a problem with some function of the machine. The buzzer can be disabled if desired for normal keypad entries.

To disable the buzzer, turn the machine on and while the display is counting down from 9 to 0, press and hold the Enter/Clear button for at least 5 seconds. The buzzer will be disabled and will remain disabled. It can be enabled again by following the same steps listed above.

Note: Even when disabled, the buzzer will sound if the tensioner has a problem and the machine requires attention. This is meant to alert the user of a problem, and can not be disabled.

MAINTENANCE & ADJUSTMENTS

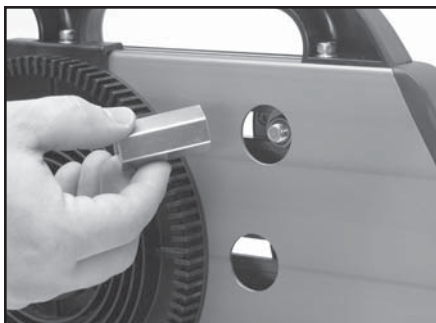

Clamp Base Locking Nut Adjustment

In the event the Locking Lever rotation is insufficient to ensure smooth operation of the clamp base, very minor adjustments to the Clamp Base Locking Nut can be made with the supplied 17mm socket and a hex wrench as a lever. Tighten or loosen the locking nut in very small increments to provide more clamping pressure or running clearance as needed.

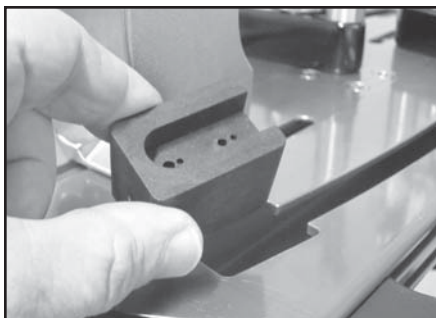

Quick Action Clamp Base Removal

Quick Action clamp bases can be removed from the turntable for maintenance or cleaning by removing clamp stop located at the end of the slot in the turntable. To remove the clamp stop, remove the two screws holding the clamp stop in place from the underside of the turntable. Lift the clamp stop out of the slot, slide the clamp base to the end of the slot and lift it out. Replace the clamp base and clamp stop in reverse order.

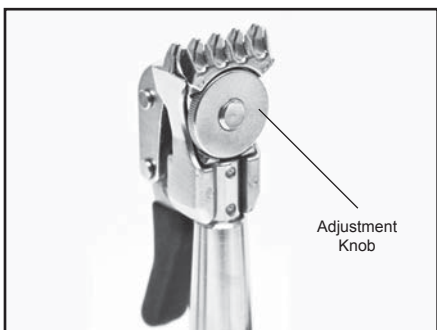

Adjusting the String Clamp Jaw Spacing

The string clamps will need minor adjustments according to what string type, construction, and gauge you are using.

To adjust the gap (clamping pressure) between the clamp jaws, insert the string through the racquet as if you were beginning the main strings. Clamp the strings and pull tension. If the string slips through the jaws of the clamp, tighten the clamp by squeezing the clamp jaws together by hand while turning the Adjustment Knob, in the clockwise direction. If the clamp leaves impressions

or damages the string, it may be excessively tight and should be adjusted by turning the Adjustment Knob counter clockwise to open the gap between the jaws.

NOTE: Due to the bearings used in the Clamp Lever the action of the Clamp Lever is very light making it easy to apply excessive clamping pressure. Clamps that are set too tight can damage the string as well as the string clamp jaws.

The clamp jaws should be cleaned periodically to be free from dirt, oil, and any string coating residue to grip properly. Knife sharpening stones are excellent for removing build-up on the diamond coated surfaces and are available.

MAINTENANCE & ADJUSTMENTS

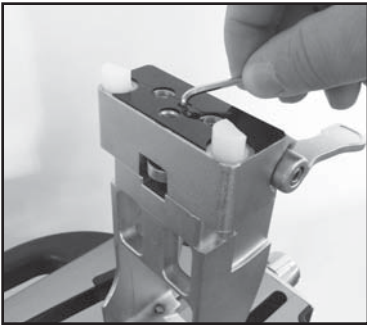

2pt Hold Down Clamp Adjustment

The 2pt hold down clamps have been adjusted at the factory. However, depending on the racquet frame thickness, the hold down clamp may require adjustment. Use a 3 mm hex wrench and turn the set screw clockwise to reduce the hold down clamp pressure and counter clockwise to increase the hold down clamp pressure.

Note: To avoid potential damage to the racquet only make small adjustments at a time by slightly turning the set screw by no more than 1/4 of a turn. Test the hold down lever to insure the racquet is held

snuggly but without applying excessive force to the lever.

Periodically clean the hold down clamp pin using rubbing alcohol to remove residue or dirt, that may build up over time.

TROUBLESHOOTING TIPS

PROBLEM

SOLUTION

String slips in clamps

- Adjust gap between clamp jaws
- Clean clamp jaws

String slips in gripper

- Clean gripper jaws
- Make sure string is wrapped over top gripper prior to inserting between gripper jaws

String clamp base slips on turntable

- Clean bottom of clamp & top of turntable with alcohol
- Adjust clamp base locking nut

Electrical system does not function

- Check power source
- Check power cord connections

String tension too tight or too loose

- Check tension using a tension calibrator, adjust machine calibration if necessary

CARE & CLEANING

With time and use, the clamping surfaces of your machine may become oily or dirty and result in string or clamp slippage while stringing. Periodic cleaning of the String Clamps, String Clamp Base and String Gripper is recommended. Knife sharpening stones work well for cleaning the diamond coated string clamping surfaces. Cleaning with a solvent such as isopropyl alcohol and a mild abrasive tool such as a toothbrush also works well to remove oily or greasy build up.

NOTES

PARTS LIST

PART #	DESCRIPTION	TOOLS & ACCESSORIES	
5	RUBBER FOOT*	109	NEEDLE NOSE PLIERS*
6B	CAP SCREW- M8x30	110	BENT NOSE PLIERS*
106	STAND BRAKE KNOB	171	DIAGONAL CUTTERS*
114	SHORT LEG	196	17MM SOCKET*
115	FLAT HEAD SCREW- M8x25	221	SLM PADS*
121	LEVELING FOOT	251	HEX WRENCH SET*
203	TT BOLTS*	324	FOOT PEDAL SWITCH*
210	STRING REEL HOLD BOLT	E16	A/C POWER CORD*
211	STRING REEL HOLD SPACER	E23	AC ADAPTER*
212	STRING REEL HOLD KNOB	MA	STRINGER'S AWL*
283	TT END CAP	MPG	STARTING CLAMP*
285	TT END CAP- RIGHT	MPS	CLEANING STONE*
286	TT END CAP- LEFT	MPSA	PATHFINDER AWL*
289	TT HANDLES	MGEMC	MACHINE COVER *
299	STRING LENGTH METER		* (NOT SHOWN)
304	SC TT KNOB		
309	2 PT PAD		
310	2 PT HOLD DOWN		
311	2 PT RQT SUPPORTS	MFSC	FLOOR STAND CASTERS
312	2 PT LEVER	MTC	CALIBRATOR
313	2 PT MOUNT STAND	SGSM	STRINGER'S MAT
314	2 PT MOUNTING ASSY		
315	2 PT GRABBER PLATE		
320	BRAKE RING		
327	TT PIN		
337	BRAKE BOX		
329	GRIPPER DRUM		
343	FRP- CHAMPAIGN		
344	FRP- BLACK		
345	TOOL TRAY PAD		
346	LOWER COLUMN SUPP		
347	UPPER COLUMN SUPP		
348	ALUMINUM FRAME		
349	TENSIONER		
362	SC TURNTABLE TT9 2PT		
389	2PT TOP CAP w/ADJ SCREW		
390	2 PT STICKER		
E82	KEY PAD / ELECTRONICS		
MDCSC13	UNIV DIECAST STRING CLAMP		
MMSGD	DIE CAST GRIPPER		

PARTS DRAWING

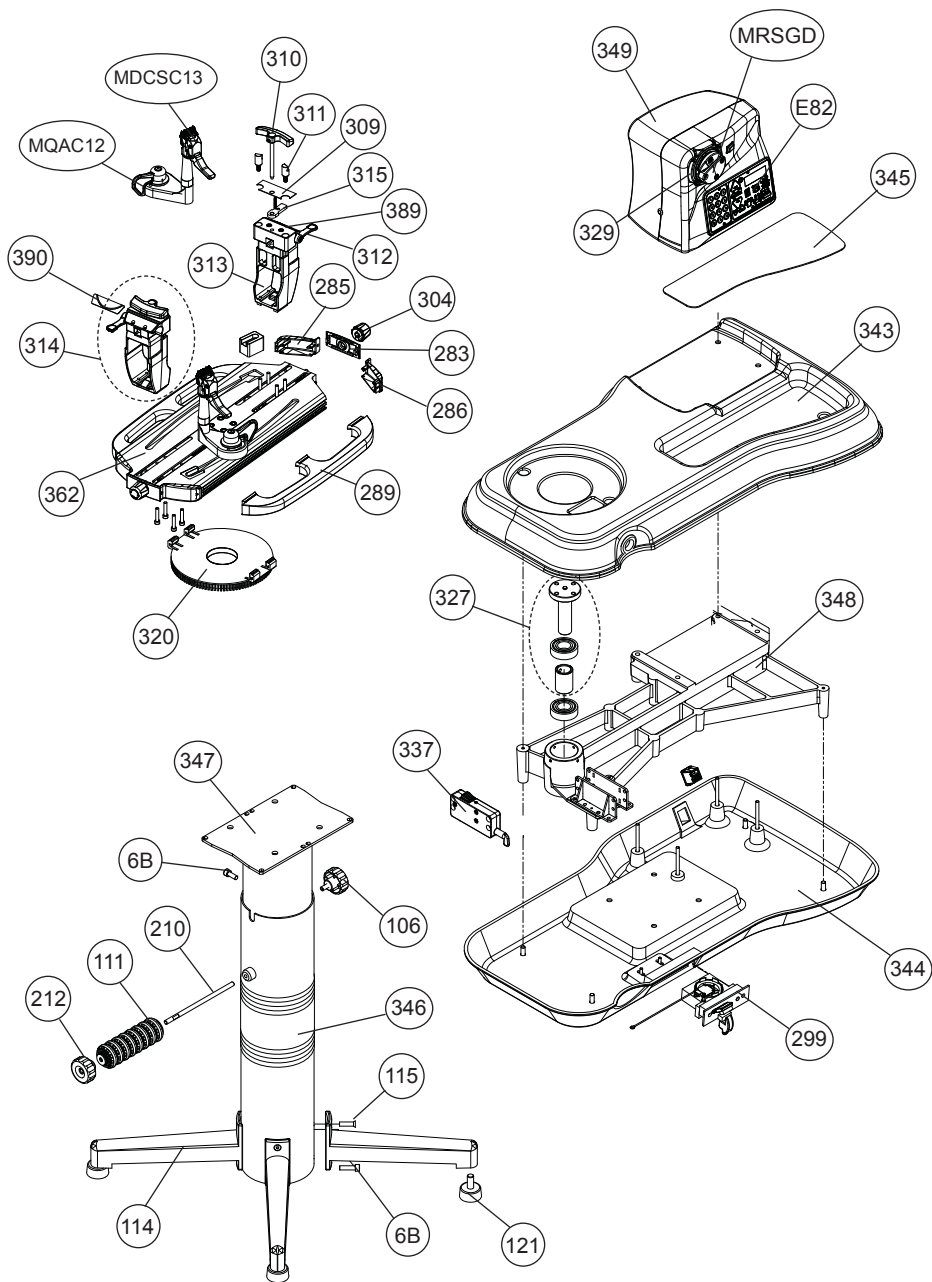



MMU2-81
(MG692-13)

GAMMA SPORTS

200 Waterfront Drive
Pittsburgh, Pennsylvania 15222
Phone: 800.333.0337 Fax: 412.323.0317
Visit our website at www.gammasports.com