

DROP

PROTECT WHAT MATTERS



Installation Manual

City Softener



INTRODUCTION

Thank You for Purchasing a DROP System!

We know you'll love your improved water quality, leak detection ability and water conservation benefits of your new DROP Water Management System from Chandler Systems. You'll soon wonder how you ever lived without it. Improving your water and protecting your home are just a few of the ways that the DROP Water Management System can improve your water system.

Be sure to check out the dropconnect.com website periodically for more information about additional DROP products as they are released.



833.BUY.DROP
(833.289.3767)



dropconnect.com

To further help you operate your new DROP system, we have provided you with many other resources for you to learn more. Feel free to call Chandler Systems when you need additional help. We also have many resources located on our website including instructional videos, and images.

DROP Connect is also active on various social media pages! Feel free to follow us for the most up to date information and news!



@dropconnect



Privacy Statement

For more information about privacy, visit our [privacy policy](#) online.

DROP Patents

For the most up-to-date list of patents, visit our patents on our website: dropconnect.com/patents.

FCC Compliance Statement:

https://dropconnect.com/sites/default/files/FCC_Compliance_Statement.pdf

Industry Canada Compliance Statement:

https://dropconnect.com/sites/default/files/Industry_Canada_Compliance_Statement.pdf

TABLE OF CONTENTS



Introduction.....	2
Table of Contents.....	3
How to Use Soft Water.....	4
How to Use Your System.....	6
System Operation Modes.....	6
Additional Features.....	6
System Maintenance and Adjustments.....	7
Installation Instructions.....	8
Contents of Carton.....	8
Precautions.....	9
System Set Up.....	10
System Start Up.....	15
DROP Remote.....	18
Common Questions.....	19
DROP Limited Warranty.....	23

Your Water Test Results

Hardness _____	gpg
Iron _____	ppm
pH _____	number
Chlorine _____	ppm

CAUTION:

- Do not subject tank to any vacuum. If there is a possibility that a vacuum could occur, a vacuum breaker must be installed.
- Do not locate unit where the tank or any lines (including drain lines) will be subject to temperatures below freezing.
- If there is not at least 10' of line between the water heater inlet and the outlet of the closest softener/filter, an expansion tank should be installed.
- Do not use Vaseline or any petroleum-based lubricants on O-rings or rubber seals. Only use food-grade silicone lubricant.
- O-rings are lubricated before leaving the factory and do not require additional lubrication before installation in most cases.
- Do not use pipe dope or any sealant other than Teflon tape on threaded connections. Threads on the control valve and on the bypass nut connections do not require any tape because they use an O-ring seal. Tape is only required on the inlet/outlet adapter fittings and on the drain line fitting (if applicable).

HOW TO USE SOFT WATER

Household Cleaning

Use less soap, detergent and household cleaners. Hardness minerals in water interfere with soap's cleaning ability. That's why most leading brands of soap, shampoo, laundry detergent and household cleaners contain chemicals that aren't necessary with soft water.

You can significantly reduce the amount of these products that you use. You may find you can use as little as one quarter of the amount you were using before you had soft water! Even though you'll use less soap, you'll get more suds and better cleaning results.



Bathing

Reduce your use of soaps and shampoos by half or more. Adjust according to your preference and results.



After bathing in soft water, your skin will feel "silky." What you'll feel is your own smooth skin without any leftover soap residue. When you bathed in hard water, you were never able to rinse this residue completely. The soap curd that left a ring on your bathtub also remained on your skin and hair, possibly causing drying and cracking. Now that you have soft water, you'll feel soft, smooth and clean. And you'll promote healthier skin and hair by eliminating the drying effects of hard water.

Laundry

Reduce or eliminate the use of fabric softeners. Fabrics washed in hard water retain soap residue making them "crackle" when removed from the dryer or stiff if air-dried. Fabric softeners are necessary with hard water to keep your clothing soft, but with soft water, you can reduce your use of fabric softeners or eliminate them altogether.

It's especially important to reduce the amount of laundry detergent you use by half or more. Washing clothes in soft water means you'll need less soap to get your clothes clean and it will rinse completely. Washing in soft water makes your clothes look whiter and brighter, and they'll last longer, too.



HOW TO USE SOFT WATER



Dishwashing

Reduce the amount of dishwashing detergent you use by half or more, too. Your dishes will get nice and clean without all of the hardness minerals left over by hard water.

Take special precautions with dishwashers. Caustic phosphates in some dishwasher detergents and very high temperatures in the dry cycle can etch dishes and glassware if you use soft water. To prevent this possibility:

- Use the “no heat” dry cycle on your dishwasher.
- Use the minimum amount of a good quality, low phosphate dishwasher detergent needed to clean your dishes.
- Wash good china and crystal by hand.



Other Considerations

Special care for plants and fish. Water your lawn, shrubs and outside plants from an outside hard water faucet, or turn off treatment from your DROP App. You may also prefer to water houseplants with hard water or water from a reverse osmosis system.



Fish accustomed to hard water may have trouble with an abrupt change to soft water. Make the change gradually over a period of seven to 14 days by blending hard and soft water until the tank contains 100 percent soft water. Once you begin using soft water, you should notice that your fish tank stays cleaner longer.

HOW TO USE YOUR SYSTEM

Your DROP Water Management System was selected to address your specific water conditions. Your system uses advanced technology to deliver effective and efficient water softening to protect your home plumbing system, deliver optimal water quality to you and your family, protect your home from leaks, and save you money, all while providing years of trouble-free operation.

Your system operates in two primary modes:

In Service: Your water passes through the softening resin in your system's media tank to remove the hardness minerals quickly and effectively.

Regeneration: Your system cleans itself by drawing a salt solution through the softening resin to dislodge all hardness minerals, backwashing the resin to remove the dislodged hardness minerals and using a final rinse to ensure the system is clean, before returning to In Service Mode. Water to your home is not treated while in regeneration.

Additional Features You'll Find on Your DROP System

- **Advanced Electronic Control Valve:** Incorporates the latest softener control technology for optimal performance, efficiency and longevity.
- **Optical Sensor Technology:** Optical sensors control regeneration for precise performance.
- **Demand Operation:** Your DROP system meters your water use and regenerates itself when necessary, saving you salt, water and money. Your system automatically adjusts to heavier or lighter water use.
- **High Flow Media Tank:** Your DROP system delivers the high flow rates required by today's demanding households.
- **High Efficiency Softening Media:** DROP softening media minimizes salt and water use to minimize operating expense.
- **Soft Water Brining:** Treated water refill for better brine saturation and a cleaner brine tank.
- **Integrated By-pass Valve:** Allows you to take your system out of service if necessary.
- **Power Backup:** To continue to protect your home during power outage
- **Water Usage Monitoring** - DROP monitors your water usage and provides real time information including: current water flow, peak flow today, daily average of the last 90 days, as well as many useful historical charts.





HOW TO USE YOUR SYSTEM

- **Automatic Low Salt Notifications** - The DROP salt sensor allows the system to provide notifications when you are running low on salt BEFORE you run out.
- **Automatically integrates with other components on your DROP System** - DROP is a water management system that integrates all of the water related devices in your home including: water softeners, backwashing filters, leak detectors, sump pump alarms, and many more to come!
- **Convenient User Interface on your Smart Phone or Tablet**
- **LED Light Codes:** Alert you to system status at a glance.
- **Regeneration Status:** During a regeneration, the App will show the cycle and the time remaining in that cycle.
- **Regeneration Cycle Override:** During regeneration, you can force the system to move to another cycle step immediately by selecting a different cycle step in the App.

System Maintenance and Adjustments

Adding Salt: Maintain salt in your system at all times to ensure your softener can properly soften your water. Only use a quality grade of salt processed especially for use in water softeners. Ensure that the salt level in the brine tank is always above the water level. If your system ever runs out of salt, refill it, wait 30 minutes and then follow the procedures in the Extra Cycle / Manual Regeneration section of this manual.



NEVER USE ROCK SALT in your DROP system; the dirt and rocks inherent in rock salt will damage your system.

Manually Bypassing Your System: DROP's integrated bypass valve allows you to bypass your system should you ever wish to take it out of service. To bypass your system, turn both handles until they are perpendicular to the system inlet / outlet. To place your system back in service, turn both handles until they are parallel with the system inlet / outlet.

SERVICE

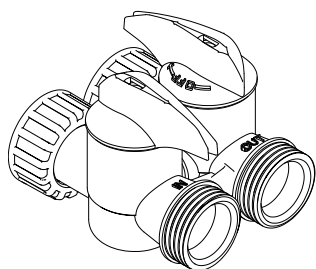

System In Service -Water to home is being treated

OFF

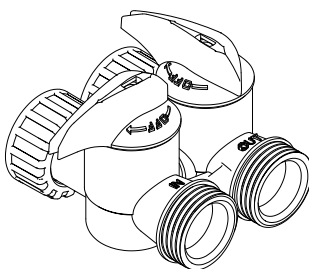

Water to home and softener is off

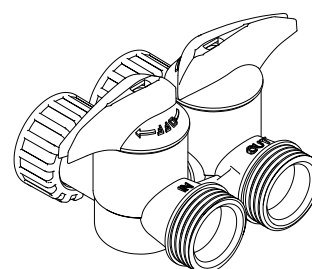

BYPASS



System Out of Service -Water to home is on and untreated

INSTALLATION INSTRUCTIONS

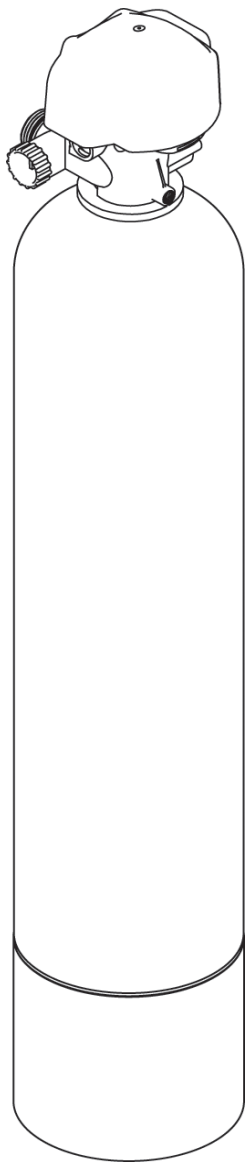
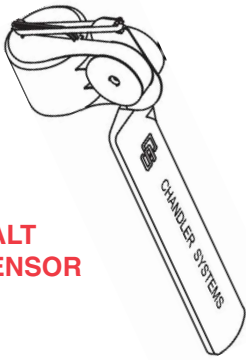
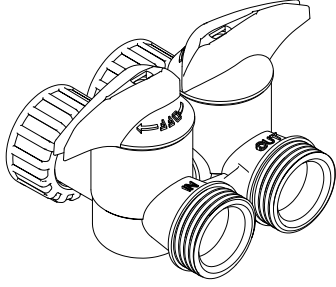
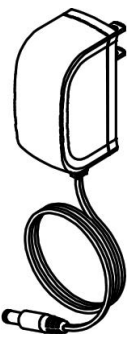
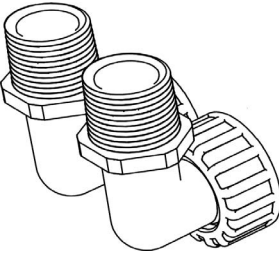
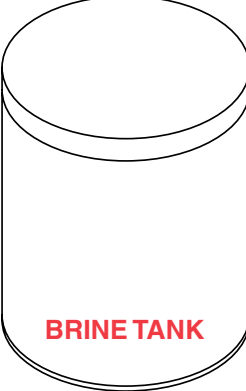
Contents of Carton

 <p>A tall, cylindrical water softener tank with a control head on top.</p> <p>SOFTENER</p>	 <p>A handheld device with a probe and a label that reads "CHANDLER SYSTEMS".</p> <p>SALT SENSOR</p>	 <p>A valve assembly with multiple ports and a handle.</p> <p>BYPASS</p>
	 <p>A small rectangular box with a cable attached.</p> <p>POWER SUPPLY (2)</p>	 <p>Two different types of threaded pipe connectors.</p> <p>CONNECTORS</p>
	 <p>A smaller, shorter cylindrical tank.</p> <p>BRINE TANK</p>	 <p>A small rectangular remote control with a cable.</p> <p>REMOTE</p>

INSTALLATION INSTRUCTIONS



Precautions

1 Read



The image shows the cover of the 'DROP Installation Manual' for 'Task 2020'. The cover features the 'DROP' logo with the tagline 'PROTECT WHAT MATTERS' and the text 'Installation Manual For Task 2020'. Logos for 'CHARVALLON ELECTRIC' and 'Apple' are also visible.

2 Ventilate

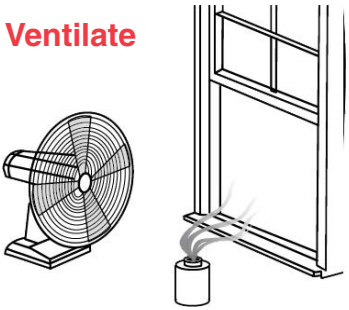

The illustration shows a box fan on the left and a window on the right. A candle is lit on a surface in front of the window, with smoke rising from it, indicating the need for ventilation during soldering.

3 Use Eye Protection



The illustration shows a pair of safety goggles with a strap, used to protect the eyes during the installation process.

4 Protect nearby materials when soldering.

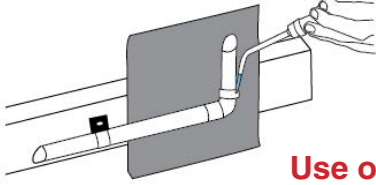

The illustration shows a person soldering a pipe. A grey heat shield is placed between the pipe and the soldering iron to protect nearby materials from heat. Below the illustration, the text reads: **Use only lead-free solder**

5 If existing plumbing is copper, install grounding strap before creating plumbing gaps.

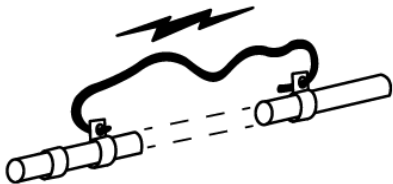

The illustration shows a copper pipe with a grounding strap attached to it. A lightning bolt symbol is shown above the pipe, indicating the need for grounding to prevent electrical hazards.

6 Don't reach.



The illustration shows a person reaching for a ladder. A red circle with a diagonal slash is drawn over the person's arm, indicating that reaching is prohibited. A ladder is shown to the right.

INSTALLATION INSTRUCTIONS

System Setup

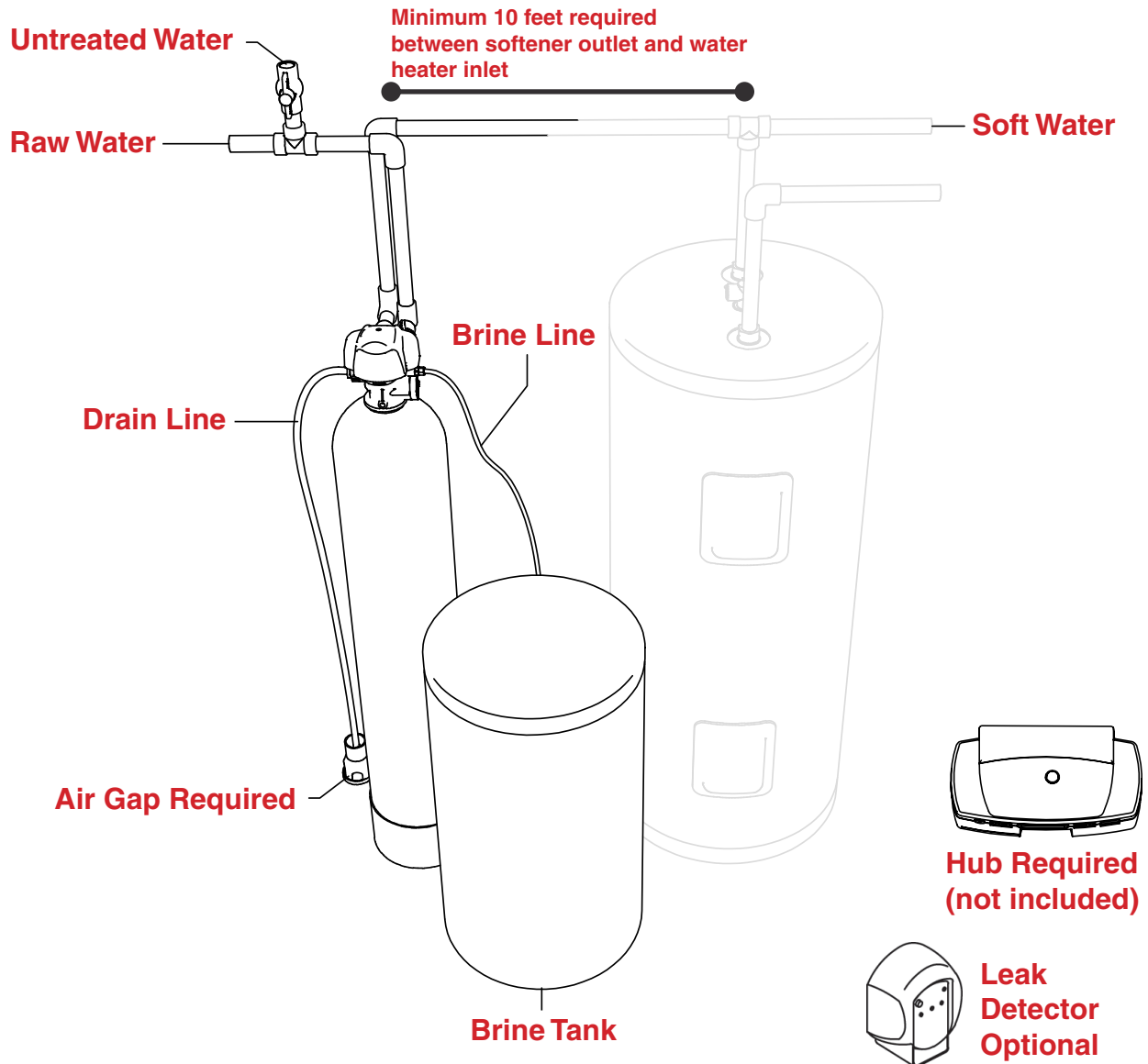

Note: Your installation may vary. Follow all local plumbing codes.

INSTALLATION INSTRUCTIONS



System Setup

Unpack equipment. Connect bypass valve, connectors. Attach components by pushing the adapters together and tightening the nuts by hand until they feel snug. Position system on a hard level surface with access to inlet plumbing, drain and electrical outlet.

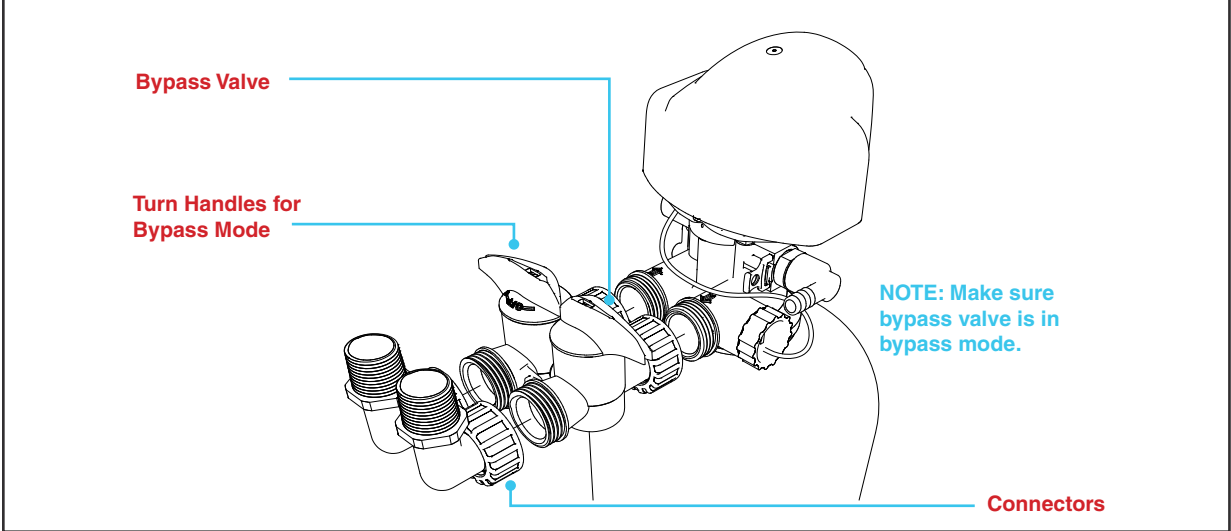

Turn off main water supply and open nearest cold faucet to relieve pressure. Cut water supply line, and connect plumbing to the inlet and outlet accordingly. Note: Inlet and outlet connections are 1" NPT. Additional piping and / or fittings may be necessary

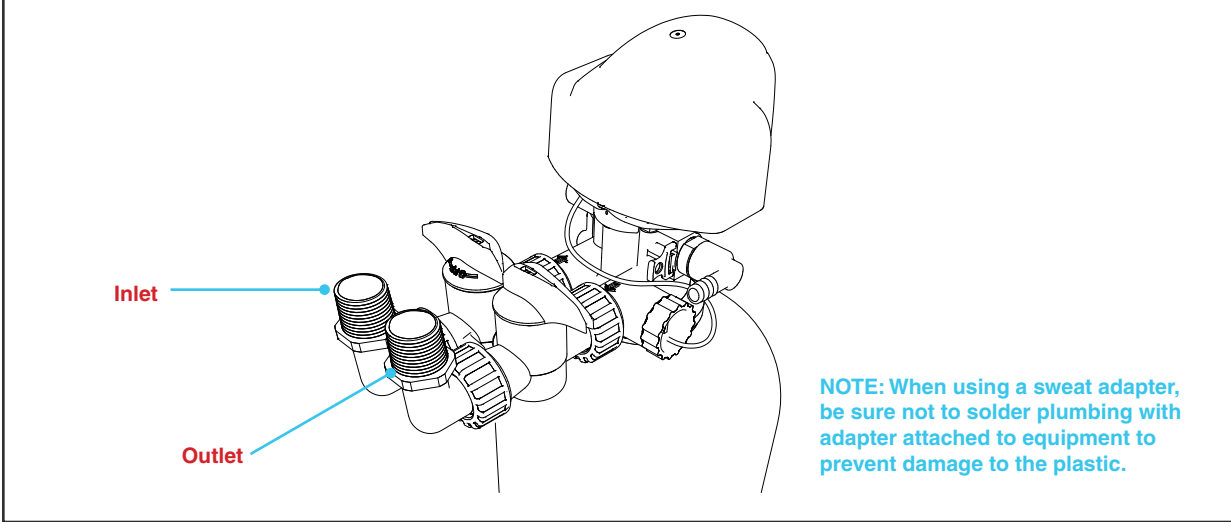

INSTALLATION INSTRUCTIONS

System Setup

Connect drain line to barbed drain adapter and run to appropriate discharge point. Use a 1/2" minimum pipe size for the drain. Use a 3/4" drain line for runs that exceed 20 feet. Make connection to a sanitary waste system through an air gap of 2 pipe diameters or 1", larger. Do not tee into any other drain lines.

Discharge Options

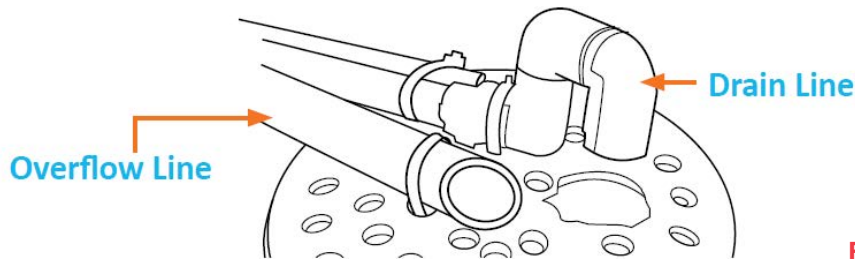
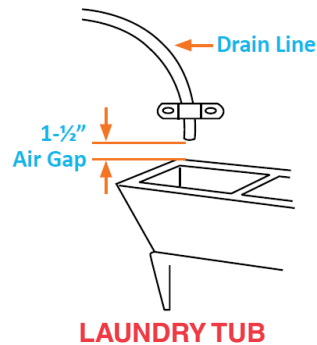
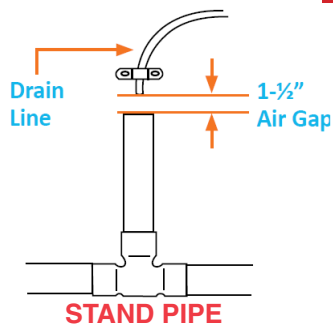

Remove brass compression nut from the softener control valve. Take brine tubing (packaged with brine tank) and slide the brass nut and plastic ferrule onto one end of the tubing. Find the plastic tubing insert (taped to the brine well cap inside the brine tank) and insert it into the end of the tubing. Next, insert the tubing into the control valve and tighten the nut.

Inside the brine tank, remove the cap from the top of the brine well. Feed the other end of the brine tubing through the hole in the side of the brine tank, and firmly insert it all the way into the push-lock elbow fitting inside the brine well. When this tubing is fully inserted, the fitting will grab the tubing and hold it in place.

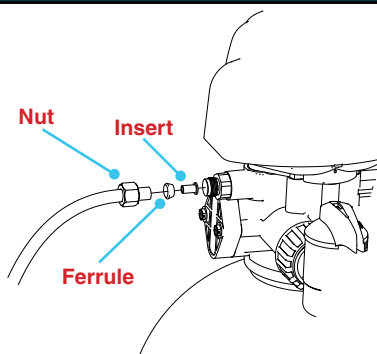

BRINE LINE CONNECTION TO CONTROL VALVE

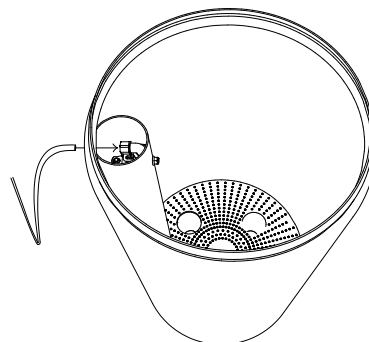

BRINE LINE CONNECTION TO BRINE TANK

INSTALLATION INSTRUCTIONS



System Setup

Attach safety overflow line (1/2" tubing) to barbed fitting on side of brine tank and run to appropriate discharge point that is lower than the overflow connection on the brine tank. Do not tee into any other drains.

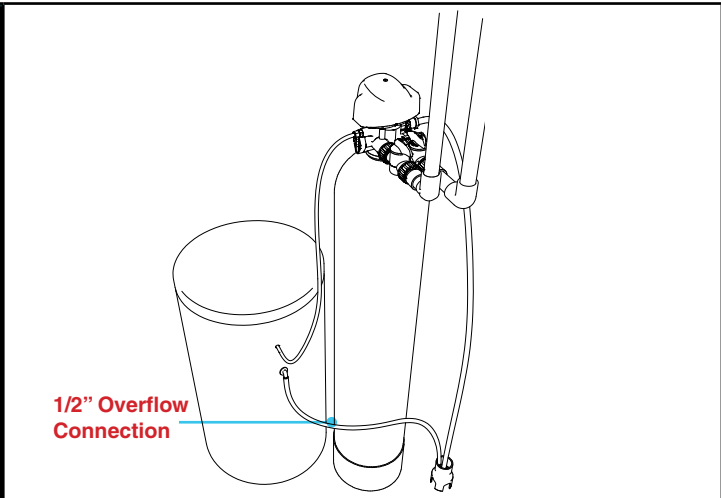

Pass the salt sensor power cord through the provided hole from the inside of the brine tank. Install the salt sensor unit onto the top of the brine well. Install the cord grip around the salt sensor power cord and insert it into the hole in the brine tank. Install the supplied rubber band onto the hooks on top of the salt sensor unit.

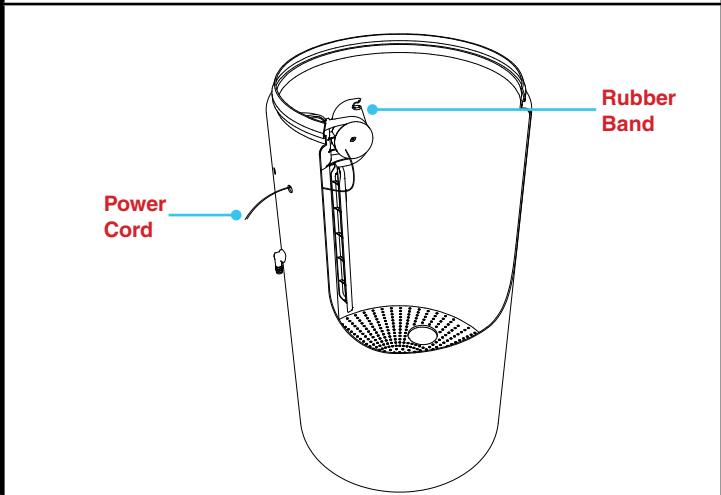

Add water to brine tank approximately 1" above the grid plate. Do not add salt to the brine tank at this time.

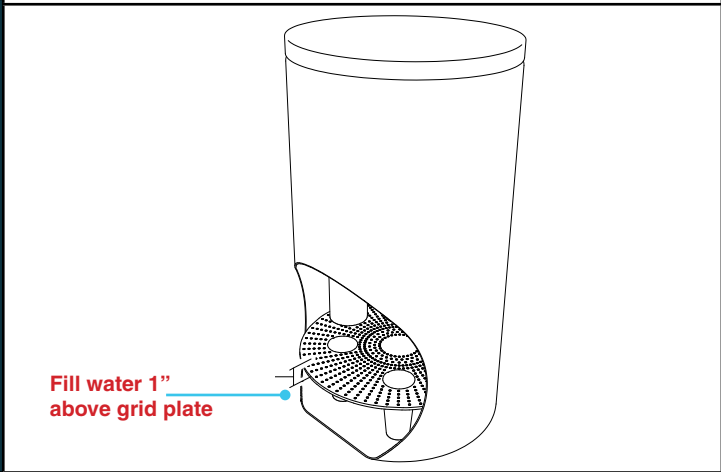

INSTALLATION INSTRUCTIONS

System Setup

This information is available in more detail in the **USER GUIDE**.

With the bypass valve in bypass position, turn on the main water supply. Open a cold soft water tap nearby and let run a few minutes or until the plumbing is free from foreign material (usually solder) that may have resulted from the installation. Once clean, close the water tap.

Place the DROP Hub in a central location in your home and plug it in. At this point, you can download the DROP Connect App on your device. When you open the app, it will walk you through the process of connecting to your Hub and connecting to WiFi, if desired.

Adding devices to the DROP system

Once you have connected to the Hub, you can use the app to connect your devices (softener, leak detectors, salt sensor, etc) to the Hub. First, unplug and remove any batteries from the DROP device you wish to add. Next, navigate to the 'System' (selection on left) > 'Advanced' (selection at top) page in the app and enable the 'Add Device Components' mode. The hub will enter a state where it will accept new connections. Plug in the device(s) that you are adding, or for a leak detector, simply install the batteries. After the device has joined the DROP network you will see it added to the "Manage Device Components" table, you can then disable the 'Add Device Components' mode or simply wait for it to automatically disable.

When a new device is added to the system, you can rename that device by choosing "System" on the left navigation menu and scrolling to the bottom of the System Status page. Devices such as the softener and salt sensor will already be labeled appropriately, but in the case of leak detectors, each individual leak detector will simply be labeled "leak detector." In this case, you can rename each leak detector according to where you put them, such as "water heater" or "kitchen sink."

Softener Programming

Your softener's control valve is setup from the factory with some default values that may need to be adjusted according to your water quality and personal schedule.

System Settings

The first settings that should be reviewed are the Regeneration Time and System Water Source. Choose "System" on the left navigation menu and it will bring you to the System Status page, where these settings can be adjusted if needed.

Regeneration Time

This setting controls the time of day when the system will begin to regenerate. While a softener is in its regeneration cycle, any water used in the house will not be treated. Therefore, it is important to choose a time of day where water use is least likely. It is also important to understand how long the regeneration of your system will take. For a softener with standard settings it will take approximately 1 hour and 30 minutes. Some DROP installations will require multiple filters and/or softeners. These stages can require regeneration on the same day and would occur one after the other starting at the regeneration time, so you should select a regeneration start time that would take these times into consideration along with your water usage schedule.

INSTALLATION INSTRUCTIONS



System Start Up

System Water Source

The system water source setting is used by the DROP system to know how to respond to power outages. It can be set to Private Well or Municipal Supply. If your water supply is not one of these choices, if your water supply is dependent on power to be available (i.e. it is supplied by an electric pump) set it to Private Well, otherwise set it to Municipal Supply.

Water Hardness Setting

The most important setting to adjust when setting up your DROP softener is the water hardness setting—this setting impacts the efficiency of your softener as well as the ability of your softener to correctly soften your water. To set the water hardness, select “Devices” on the left navigation menu and then select the softener from the devices list. You should then be viewing the Softener Status page. On this page you will be able to adjust your water hardness setting. The water hardness is a measurement of mineral content (calcium and magnesium) in the water and is measured in **Grains Per Gallon (gpg)**. A water test should have been done on your water to determine the hardness measurement of your water source. Use this measurement as the value for the water hardness setting on your system.

Note: If you have had a water test performed, but the results are listed in Parts Per Million (ppm) or Milligrams Per Liter (mg/l), you can convert this number to Grains Per Gallon by dividing the ppm or mg/l by 17.1, and then rounding up to the nearest whole number.

Note: If the water contains iron and / or manganese, add together the total ppm or mg/l of iron and manganese, and multiply this number by 4. Then add this number to the grains per gallon (gpg) of hardness to calculate your compensated hardness. Use this compensated hardness level when programming the hardness.

System Startup Procedure

Note: In the steps following it is necessary to skip regeneration cycle steps. To accomplish this, first you must be on the **DEVICES > SOFTENER > STATUS** page of the app. At the top, just below the Softener Status title, tap the softener unit that you are starting up (usually there will only be one choice, Unit 1). Once the unit is selected, the Unit Status Details will appear. When the unit is in regeneration, a Current Position will appear on the left. Tap on the Current Position and a list of all the regeneration positions will expand (see screenshot next page), they will be in order of the regeneration steps. Simply choose the step that you would like the valve to be in. You can even go back to a previous step if needed.

INSTALLATION INSTRUCTIONS

System Start Up

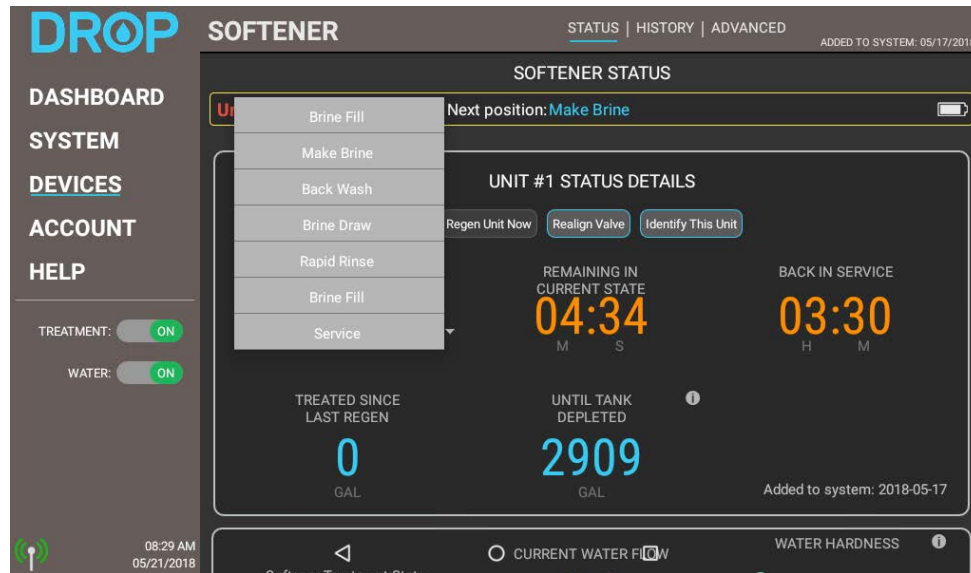

1. Navigate to the **DEVICES > SOFTENER > STATUS** screen in the app and select the “Start Regeneration Now” button. Skip the “Brine Fill” and “Make Brine” steps to cycle the softener to the backwash position.
2. Partially open the inlet valve on the bypass—about halfway—to allow water to slowly begin entering the softener tank. As water enters the tank, excess air will be expelled out of the drain line.
3. Once there is a steady flow of water coming out of the drain line, slowly open the inlet valve the rest of the way. After 10 minutes, the softener will enter the brine draw stage of the regeneration cycle. You do not need to stay in this step for long, but before you skip to the next step, look inside the brine tank and verify that water is being drawn out in this step. If there is no sign of water being drawn out, you may need to check the brine tubing connections.
4. Next, you can use the app to the “rapid rinse” step. In this step, there should be a strong flow of water coming out of the drain line, as there was in the first step. Stay in rapid rinse until the water runs clear.
5. After “rapid rinse”, you can skip to brine fill. The softener does not need to go through a complete refill, since you already filled the brine tank earlier, but you should stay in this step long enough to observe that water is entering the brine tank, and to make sure that the water level is at least 1” above the salt grid plate. Then you can return the control valve to the “Service” position.
6. Open the outlet valve of the bypass so that water is now able to flow through your softener and into your service lines. Your softener will now begin softening your water.

INSTALLATION INSTRUCTIONS



System Start Up

7. Last, add salt to your brine tank. When adding salt, make sure that you remove the rubber band from the top of the salt sensor, and that the salt sensor paddle is laying flush with the brine well. Add several bags of salt, pouring toward the salt sensor paddle. Once the salt level is high enough to hold the paddle in place, you can attach the rubber band to the top of it. When your salt level drops below the paddle, the paddle will flip out and send a signal to the DROP Hub, telling you that you need to add salt. When you receive a “low salt” indication—don’t panic—you still have several regeneration cycles worth of salt; it reminds you early enough to make sure that you have plenty of time to remember to get salt. If you ever run out of salt completely, just add salt and then select the “Start Regeneration Tonight” button in the Softener Status menu of the app.

Resin Grains Capacity and Salt Settings

The settings used to configure your softener to correctly regenerate the resin in your softener treatment tank are found in the app by going to **DEVICES > SOFTENER > ADVANCED**.

The first setting to verify is the Resin Grains Capacity for each softener unit, located in the ‘Unit Settings’ section at the bottom of the Advanced page. Each valve should be preconfigured at the factory to match the capacity of the resin in the treatment tank. Match the model number and resin grains capacity values in the table below and confirm that the resin grains capacity of your DROP system is configured correctly.

The length of the Brine Refill regeneration step determines how much salt is used per regeneration. The recommended default brine fill time for each model is listed in the table below. Decreasing the amount of salt used during a regeneration makes the softener more efficient because each pound of salt used is more effective, but this uses more water during regeneration because the unit must regenerate more frequently. After selecting a Brine Refill step time, the app will display how much salt will be used for each regeneration, the effective resin grains capacity of the treatment tank, and a simple graph that illustrates the relationship between salt and water consumption during the regeneration.

It is recommended to begin using your softener with the default brine refill time. If you wish to increase salt efficiency (by decreasing the Brine Refill time) or increase water efficiency (by increasing the Brine Refill time), adjust the Brine Refill time incrementally and observe the effect on salt usage and regeneration frequency before making further changes.

RECOMMENDED SALT SETTINGS

MODEL	CAPACITY	BRINE REFILL TIME	SALT LBS. USED PER REGENERATION
SC-32	32,000	5:52	8.8
SC-48	48,000	8:48	13.2

INSTALLATION INSTRUCTIONS

You will need to check your Brine Refill time setting and resin grains capacity setting and set them according to the table above. The Brine Refill time setting can be found in the app by going to **DEVICES > SOFTENER > ADVANCED**. This setting determines how much salt is used per regeneration. Do not change this setting away from the recommendation unless you understand the effects of the changes. Changes to this setting can great effect efficiencies and the softeners ability to make soft water.

Extra Cycle / Manual Regeneration: Should you ever need to initiate an extra regeneration due to unexpected higher water use, use the **Regenerate Now** button in the App.

NOTE: If your hot water tank has refilled with hard water, it may take several days for it to empty and for your water to feel soft again.

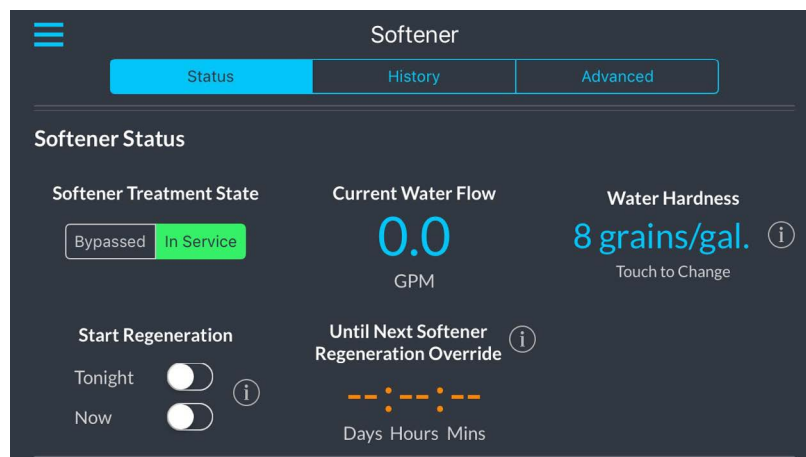

DEVICES > SOFTENER > STATUS

(Navigation description examples can be found in the User Guide)

THE DROP REMOTE



Every DROP System sold as a bundle comes with one DROP Remote.

In addition to acting as a DROP Link mesh network extender, the DROP Remote has additional features:

At a glance the remote can provide the status of your water system through color codes.

Color codes for normal operation

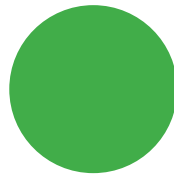

Water is in Service

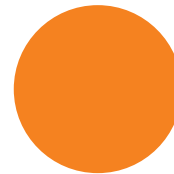

Water is Shutoff

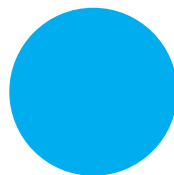

Slow blinking indicates you have a notification in your DROP App that has not been seen

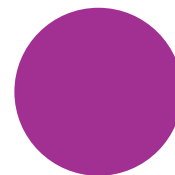

Flashes indicate that the DROP Remote is communicating with other devices

To turn off water in your home, place your finger on the water DROplet button for about 2 seconds. Once the lights turn orange, remove your finger.

If your system is in the Shutoff mode and you would like to turn your water back on, place your finger on the DROplet button for about 2 seconds. When it turns green, remove your finger and your water will turn back on.

More details about the DROP Remote can be found in the DROP User Guide.

COMMON QUESTIONS



9 Volt Battery back up enables your valve to continue to protect your home from leaks during a power outage.

There has been a drop in my home's water pressure. What can be the cause? A reduction in your home's water pressure can indicate that it is time to change your prefilter. If you do not have a prefilter with your system or changing the filter has no effect, contact your authorized DROP Water Management System representative.

My system seems to be regenerating more frequently. Is this normal?

Remember, your DROP system is demand operated, adjusting automatically to your water usage. If you do not think that your water usage has increased due to extra house guests, additional laundry or some other reason, check for any leaky plumbing, dripping faucets or running toilets, all of which can contribute to more frequent regenerations.

My water doesn't seem soft. How can I be sure that my system is regenerating properly?

Be sure that the water supply to the softener is not by-passed and there is salt in the brine drum. Follow the instructions in the "Extra Cycle / Manual Regeneration" section on page 17 to manually regenerate the softener tank. If the unit does not advance through to the next regeneration automatically, please contact your DROP Water Management System representative for further assistance.

How will I know when it is time to add salt? DROP Systems provide notification when salt needs to be added. To check manually, lift the lid of the brine drum to check the level of salt. If you can see water, it is time to add salt. You can add salt anytime there is enough room to accommodate additional blocks or pellets.

Is it okay to drink soft water? Yes, soft water is okay for drinking and cooking. If your softener regenerates with sodium chloride (salt), keep in mind that there will be a small amount of sodium added to the softened water. People who are on sodium restricted diets should consider the added sodium as part of their overall sodium intake. If sodium is a concern, potassium based salt (potassium chloride) can be used as an alternative or an under-counter reverse osmosis system can be installed to remove sodium.

If at any time you feel your system is not operating properly, by-pass the system and call your authorized DROP Water Management System representative.



**Chandler Systems
Inc.**

710 Orange St.
Ashland, OH 44805

P. 1 833 BUY-DROP
www.dropconnect.com

Note: This equipment has been tested and found to comply with the limits for a Class B digital device, pursuant to part 15 of the FCC Rules. These limits are designed to provide reasonable protection against harmful interference in a residential installation. This equipment generates, uses and can radiate radio frequency energy and, if not installed and used in accordance with the instructions, may cause harmful interference to radio communications. However, there is no guarantee that interference will not occur in a particular installation. If this equipment does cause harmful interference to radio or television reception, which can be determined by turning the equipment off and on, the user is encouraged to try to correct the interference by one or more of the following measures:

- Reorient or relocate the receiving antenna.
- Increase the separation between the equipment and receiver.
- Connect the equipment into an outlet on a circuit different from that to which the receiver is connected.
- Consult the dealer or an experienced radio/TV technician for help.

This product may be covered by one or more patents. (<https://dropconnect.com/patents>)



WATER MANAGEMENT SYSTEMS

This warranty cannot be transferred - it is extended only to the original purchaser or first user of the product. By accepting and keeping this product, you agree to all of the warranty terms and limitations of liability described below.

Important Warning: Read carefully the DROP Water Management Systems Equipment Installation, Operating and Maintenance Instructions Manual to avoid serious personal injury and property HAZARDS and to ensure safe and proper care of this product.

*FOR AS LONG AS YOU OWN AND LIVE IN YOUR SINGLE FAMILY HOME, this warranty covers your water treatment equipment, if you are the first user of this DROP Water Treatment Systems equipment and purchased it for single family home use - subject to all of the conditions, limitations and exclusions listed below. Purchasers who buy the DROP equipment for other purposes, and other component parts are subject to more limited warranties and you should read all of the terms included in this form to make sure you understand your warranty.

What is covered by this warranty?

Chandler Systems, Inc. warrants that at the time of manufacture, the DROP equipment shall be free from defects in material and workmanship as follows:

Product	Warranty
Residential Mineral Tank	10 Years
DROP Control Valves	5 Years
DROP Pump Controllers	5 Years
DROP Home Protection Valve	5 Years
Brine Tank	5 Years
DROP Hub and Remote	1 Year
DROP Wireless Low Salt Alarm	1 Year
Other Accessories and Parts	1 Year
Brine Tank Components	1 Year

* This warranty does not include media and/or cartridge filter elements.

Additional Terms & Conditions

What Chandler Systems Inc will do if you have a covered warranty claim; Chandler Systems Inc will at its discretion either make repairs to correct any defect in material or workmanship or supply and ship either new or used replacement parts or products. Chandler Systems, Inc. will not accept any claims for labor or other costs.

Additional Exclusions and Limitations

This warranty is non-transferable and does not cover any failure or problem unless it was caused solely by a defect in material or workmanship. In addition, this warranty shall not apply:

- If the equipment is not correctly installed, operated, repaired and maintained as described in the Installation, Operating & Maintenance Instructions Manual provided with the product.
- Defects caused as a direct result of the incoming water quality
- If the DROP equipment is not sized appropriately for the intended job.

- To any failure or malfunction resulting from abuse (including freezing), improper or negligent; handling, shipping (by anyone other than DROP)
- If the unit has not always been operated within the factory recommended temperature limits, and at a water pressure not exceeding 125 psi, during storage, use, operation, accident; or alteration, lightning, flooding or other environmental conditions.
- To any failure or malfunction resulting from failure to operate the system with potable water, free to circulate at all times; and free of damaging water sediment or scale.
- This warranty does not cover labor costs, shipping charges, service charges, delivery expenses, property damage, administrative fees or any costs incurred by the purchaser in removing or reinstalling the water management equipment.
- The warranty does not cover any claims submitted more than 30 days after expiration of the applicable warranty, and does not apply unless prompt notice of any claim is given to an authorized DROP Dealer or to DROP or a designated contractor is provided access to the installation and to the water treatment equipment.

THESE WARRANTIES ARE GIVEN IN LIEU OF ALL OTHER EXPRESS WARRANTIES. NO DROP REPRESENTATIVE OR ANY OTHER PARTY IS AUTHORIZED TO MAKE ANY WARRANTY OTHER THAN THOSE EXPRESSLY CONTAINED IN THIS WARRANTY AGREEMENT.

Additional Warranty Limitations

ANY IMPLIED WARRANTIES THE PURCHASER MAY HAVE, INCLUDING THE IMPLIED WARRANTIES OF MERCHANTABILITY AND FITNESS FOR A PARTICULAR PURPOSE, SHALL NOT EXTEND BEYOND THE APPLICABLE TIME PERIODS SPECIFIED ABOVE. Some states do not allow limitations on how long an implied warranty lasts, so the above limitations may not apply to you.

Limitations of Remedies

The remedies contained in this warranty are the purchaser's exclusive remedies. In no circumstances will Chandler Systems, Inc. or the seller of the product be liable for more than, and purchaser-user's remedies shall not exceed, the price paid for the product. In no case shall Chandler Systems, Inc. or seller be liable for any special, incidental, contingent or consequential damages. Special, incidental, contingent and consequential damages for which Chandler Systems, Inc. is not liable include, but are not limited to, inconvenience, loss or damage to property, consequential mold damage, loss of profits, loss of savings or revenue, loss of use of the products or any associated equipment, facilities, buildings or services, downtime, and the claims of third parties including customers. Some states do not allow the exclusion or the limitation of incidental or consequential damages, so the above limitations or exclusion may not apply to you.

What to do if you have a problem covered by this warranty

Any warranty coverage must be authorized by Chandler Systems, Inc.. Contact the person from whom you purchased the product, who must receive authorization from a DROP Dealer.

If your product is new and not used and you wish to return it, contact your DROP Dealer.

Copyright Chandler Systems Inc. DROP is a product of Chandler Systems Inc. All rights reserved.

CITYSOFTV3
0720TV