

Manual Book

Retractable Ceiling Fans

Model No.: HY-8222

Size: 52 inches



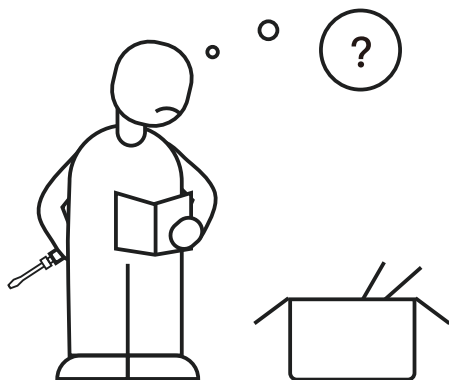

Please contact us with following information:

1. Screen shot of your order page, including product picture, name and order ID number.
2. Problem details with pictures / short video if possible.

✉ **Email: homechandelier@qq.com**

Packing List

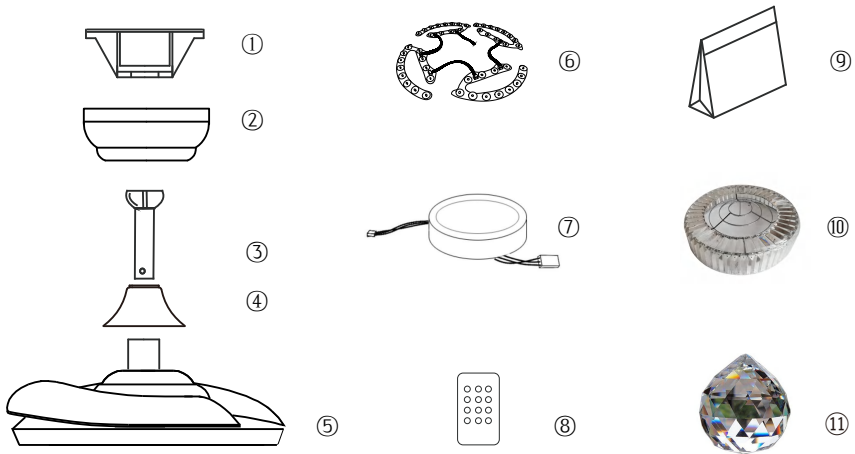

Name	QTY	Name	QTY
① Mounting Bracket	1	⑦ LED Driver	1
② Canopy	1	⑧ Remote Control	1
③ Downrod	2	⑨ Hardware Bag	1
④ Adapter Cover	1	⑩ Light Shade	1
⑤ Fan Motor Assembly	1	⑪ Crystal Ball	61
⑥ LED Panel	1		

Please open your package and check the accessories according to the packing list.

NOTE:

1. Downrod: short x 1pcs, long x 1pcs

2. Remote control requires AAA 1.5V battery x 2pcs (**not included**)

3. Rectangle crystals in the package are only for the spare parts of the assembled light shade, not for hanging like crystal balls.

Safety Rules

1. Be sure the power to the wires you are working on is disconnected, either the fuse is removed or the circuit breaker is turned off. Turning the power off using the light switch is not sufficient to prevent electrical shock.
2. A qualified licensed electrician is required for the installation.
3. The outlet box and support structure must be securely mounted and capable of reliably supporting a minimum of 50 pounds. Use only UL (cUL for Canadian Installation) listed mounting boxes marked "FOR FAN SUPPORT".
4. The fan must be mounted with a minimum of 7 feet clearance from the trailing edge of the blades to the floor.
5. Do not operate reversing switch while fan blades are in motion (if applicable). Fan must be turned off and blades stopped before reversing blade direction.
6. Do not place any objects in the path of the blades.
7. To avoid personal injury or damage to the fan and other items, be cautious when working around or cleaning the fan.
8. Do not use water or detergents when cleaning the fan or fan blades. A dry dust cloth or lightly dampened soft cloth will be suitable for the cleaning.
9. After marking electrical connections, spliced conductors should be turned upward and pushed carefully up into outlet box. The wires should be spread apart with the grounded conductor on one side of the outlet box.
10. Electrical diagrams are reference only, different fan light may have different light shade and bulbs.
11. Use only our replacement parts. This equipment has been tested and found to comply with the limits for a class B digital device, pursuant to part 15 of the FCC Rules. These limits are to provide reasonable protection against harmful interference in a residential installation. This equipment generates, uses and can radiate radio frequency energy and if not installed and used in accordance with the instructions may cause harmful interference to radio communications.

Warning:

To reduce the risk of personal injury, use only the two steel screws and washers provided with the outlet box for mounting to the outlet box. Most outlet boxes commonly used for the support of lighting fixtures are not acceptable for fan support and need to be replaced, consult a qualified electrician if in doubt.

To reduce the risk of fire, electric shock or person injury, mount fan to outlet box marked "acceptable for fan support".

To reduce the risk of personal injury, do not bend the blade brackets (also referred to as flanges) during assembly or after installation. Do not insert objects in the path of the blades.

1. Installation Preparation

Tools You Need



Ladder

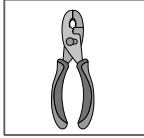

Pliers

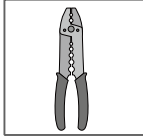

Wire Strippers

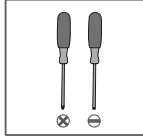

Screwdrivers

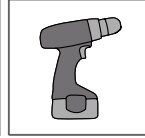

Power Drill (optional)



Drill Bit (optional)

If mounting to a support structure, you will also need the optional tools.

What to Expect with Your Installation

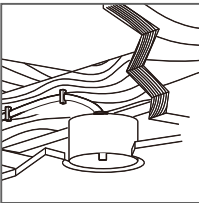

Must be able to secure the fan to building structure or fan-rated outlet box

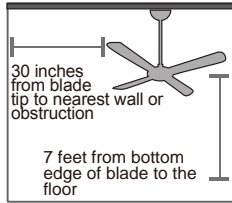

Assess location



Check box to see fan weight

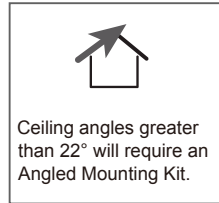

Assess ceiling angle

Mounting Options

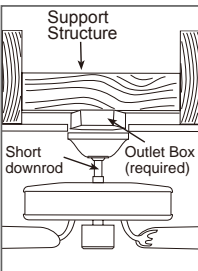

Use short downrod for flat and less than 9 feet ceiling.

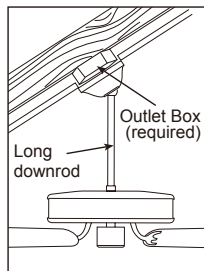

Use long downrod for high or angled ceiling less than 22°.

NOTE: For longer downrod or angled ceiling greater than 22°, please contact us.

2. Installing the Fan

NOTE: This ceiling fan is supplied with two types of hanging downrods:

1. The short downrod for "close-to and flat ceiling" installation (less than 9 feet).
2. The long downrod for high or angled ceiling less than 22°.
3. Please contact us if you need longer downrod or angled ceiling greater than 22°.

1. Installing the Bracket

Step 1. Pass the power wires through the center hole in the mounting bracket as shown in Fig. 5.
Step 2. Secure the mounting bracket to the ceiling outlet box with the screws and washers provided with your outlet box.

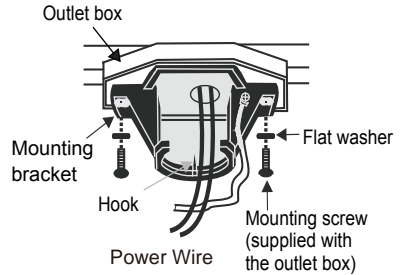

Fig. 5

2. Assembling the Fan

Step 1. Assemble the canopy and adapter cover as Fig. 6.
Step 2. Remove the the bolt, pin and set screws from the top of the fan motor assembly.
Step 3. Route wires from the top of the fan motor through downrod/ ball.

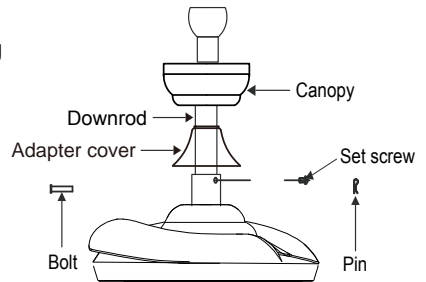

Fig. 6

Step 4. Align the holes at the bottom of the downrod with the holes in the collar on top of the motor housing (Fig. 6). Carefully insert the bolt through the holes in the collar and downrod. Be careful not to jam the bolt against the wires inside the downrod. Insert the pin to the end of the bolt (Fig. 6).
Step 5. Fix the downrod with set screws provided.

3. Hanging the Fan

Place the downrod ball into the bracket socket (Fig. 7). Be sure the fixation slot is locked by the bracket.

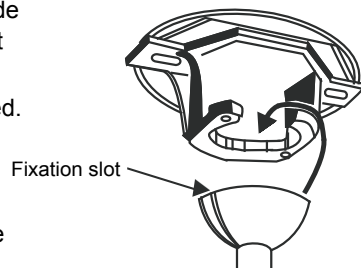

Fig. 7

3. Wiring

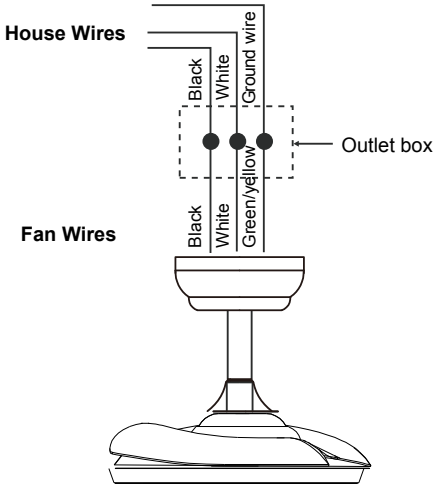

Fig. 8

NOTE: THIS FAN ONLY NEEDS ONE SET OF INPUT WIRES (black, white and ground wire). Both of the fan and lights will be controlled by the remote controller. The wall switch is not able to control the fixture full functionally.

THIS FAN CAN ONLY BE CONNECTED ONTO ON/OFF SWITCH IF YOU HAVE ONE, NOT SUITABLE FOR DIMMAER SWITCH.

Step 1. Connect the fan live wire (black) to your house live wire (black).

Step 2. Connect the fan neutral wire (white) to your house neutral wire (white).

Step 3. Connect the fan ground wire (from downrod, green/yellow stripe) to your house ground wire (optional).

Step 4. After connecting the wires, spread them apart so that the live wires are on one side of the outlet box and the neutral wires are on the other side.

4. Attaching the Canopy

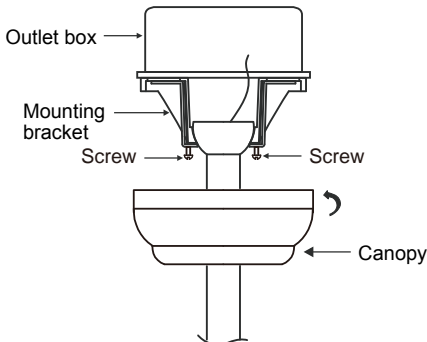

Fig. 9

Step 1. Insert the wires and wire connectors into the outlet box.

Step 2. Slide the canopy up to the ceiling and attach it to the mounting bracket with the screws provided. Tighten all screws securely.

5. Installing Bulb and Light Shade



Model No.: HY-8222



Step 1. Get ready for the fan motor assembly (see the previous instruction).



Step 2. Attach the LED panel and LED driver onto the pan by the magnet.

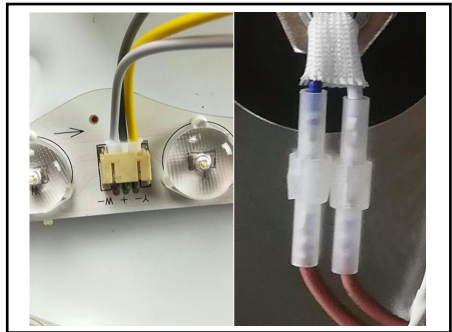

Step 3. Connect the LED driver to the power wire and the LED panels.

NOTE:

1. Wire connector maybe different from the picture.
2. Please make sure the LED panels will not touch with the LED driver, the frame and the fan base except for the magnets.

Continue

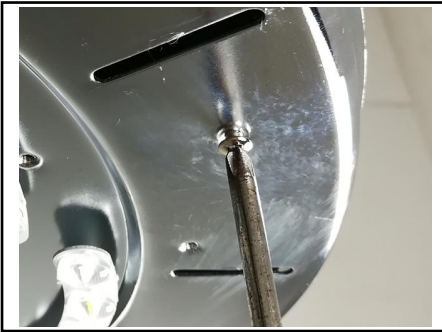

Step 4. Take off the screws from the base.



Step 5. Attach the frame with the screws. Longer screw driver recommended.

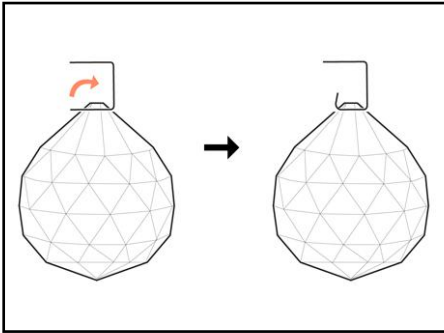

Step 6. Hook the crystal balls with the clips provided. Hook one ball with the 2- octagon crystal strand.

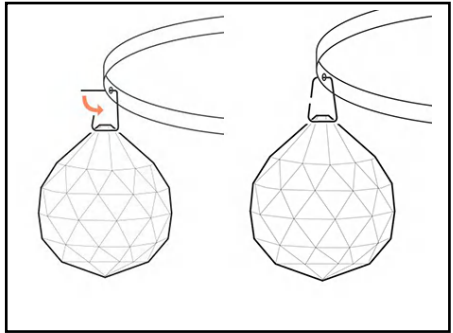

Step 7. Hook the crystals onto the frame. Hook the octagon strand in the center of the frame.

NOTE:

1. Wire connector/ shade style maybe different from the picture.
2. Please make sure the LED panels will not touch with the LED driver, the frame and the fan base except for the magnets.
3. Rectangle crystals in the package are only for the spare parts of the assembled light shade, not for hanging like crystal balls.

LED Wiring Details-1

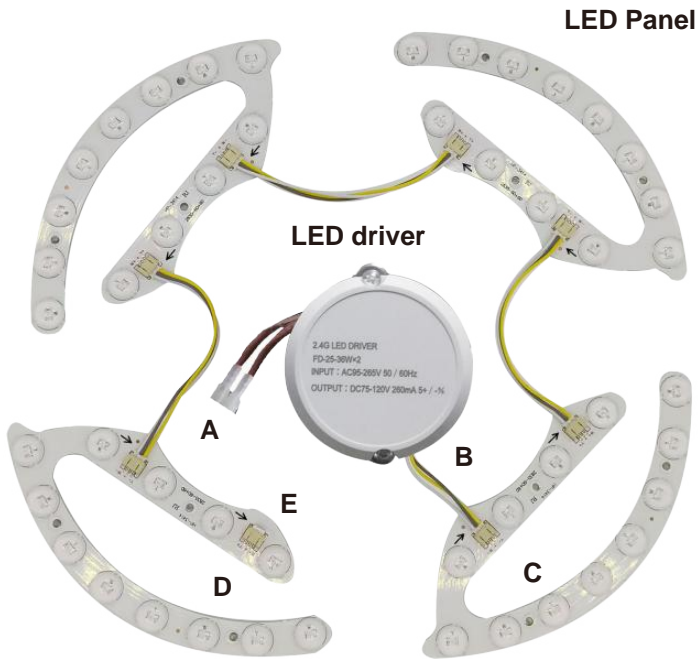

- A. LED driver input wire: connects to fan base
- B. LED driver output wire: connects to LED panel input slot C
- C. LED panel input slot: connects to LED driver output wire B
- D. LED panel ending slot: inserted with a circuit adapter E
- E: Circuit adapter

NOTE:

1. Please connect the LED driver to the LED panels according to the arrow direction on the panels.
2. Please do not take out the circuit adapter from the ending slot.
3. Any disconnection of all of the wires and the missing circuit dapter will cause the LED stop working.
- 4. Please do not change the connection if the LED panels are already assembled.**

LED Wiring Details-2

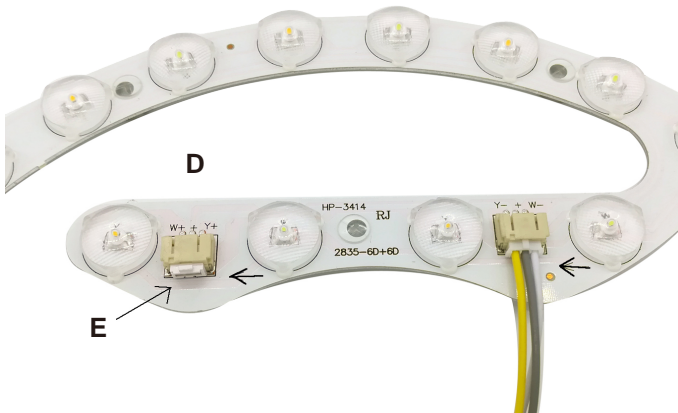
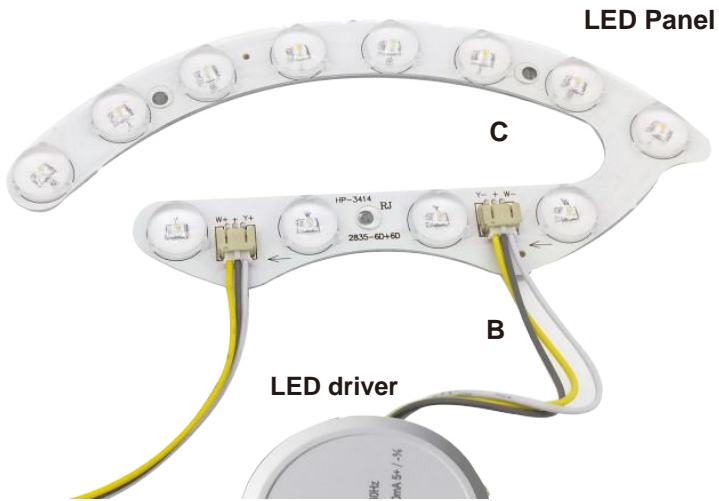

D. Ending slot

E. Circuit adapter

Please do not change the connection if the LED panels are already assembled.

Remote Control Instructions

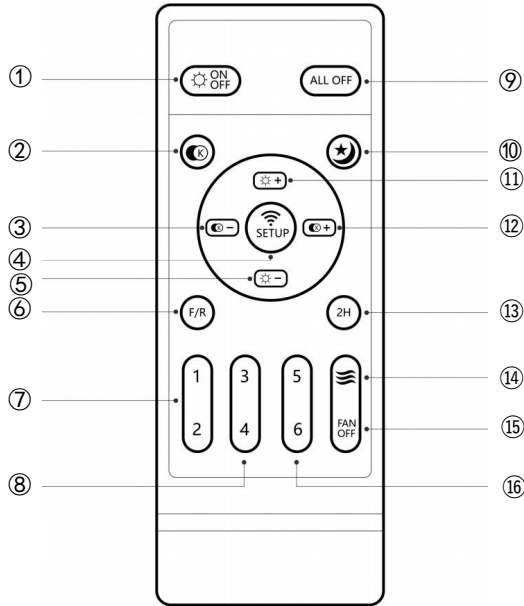

NOTE:

**Please insert 2 batteries before using.
AAA 1.5V battery x 2pcs (not included)**

- ① Turn on/off the light.
- ② Quick switch of the light color: warm white→cool white→daylight white
- ③⑫ Adjust the light color temperature.
- ④ SETUP: remote signal pairing. If the remote control loses signal of the fan, press this button at the very beginning after it's turned on from wall switch. After the signal light flashes for 3 times, it's done.
- ⑤⑪ Adjust the brightness of the light.
- ⑥ Fan moves forwards or reversely.
- ⑦⑧⑬ Fan speed.
- ⑨ Turn off fan including the light.
- ⑩ Night mode, lights will be dimmed when press this button.
- ⑬ Timing for 2 hours for the fan.
- ⑭ Natural wind of the fan, fan speed will change automatically when use this function.
- ⑮ Turn off the fan.

Trouble Shooting

1. Fan doesn't work

- Press a fan speed button (1-3).
- Check the remote control battery (not included in this package).
- Check the circuit breaker to ensure the power is turned on.
- Make sure the blades spin freely.
- Turn off power from the circuit breaker, then loosen the canopy and check all the connections according to the wiring diagram.

2. LED panel doesn't light up

- Check the wire connectors to see if all of them are connected correctly.
- Check the circuit adapter to see if it's inserted in the ending slot of the LED panels.

3. LED light doesn't turn off

- Adjust the LED panels, no touching with the LED driver, the frame and the fan base except for the magnets.
- If above step doesn't help, please use the insulation tape to cover each magnet of the LED panels and LED driver, then attach the panels and driver as above step.

4. Noisy Operation

- Tighten the light fitting
- Re-tighten all screws on bracket, downrod and fan blades (do not over tighten)
- Check to see if any of the blades are cracked. If so, replace all of the blades.

5. Remote does not work

- Make sure the battery is installed correctly.
- Install 2 new batteries.

6. Excessive wobbling

- Tighten all of the blade screws until they are snug.
- Turn the power off, support the fan carefully, and check that the hanger ball is properly seated.

- Use the provided balancing kit and instructions to balance the fan:

Step 1. Attach the magnet to place ①, ②, ③ or ④, turn on the fan and test where it needs the balance kit.

Step 2. Replace the magnet with the balance paster.

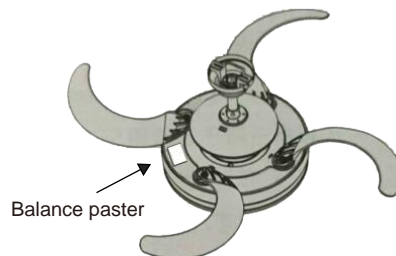
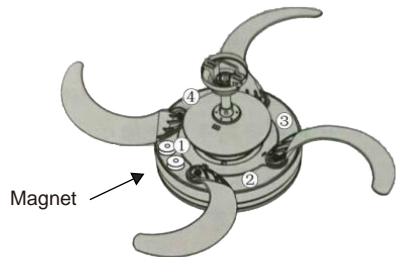

7. LED panels flicker/ Noisy operation

- Check the LED panel to make sure it's installed correctly.
- Make sure you only connect the fan onto your ON/OFF switch if you have one, not a dimmer switch.

Clean And Care

To clean, wipe fixture with soft cloth. Spray from chemical cleaners can discolor the finish of fixture. Do not use scouring pads, powders, steel wool or abrasive paper to clean this fixture.

Ordering Parts

Keep this manual for future reference, and in case replacement parts are needed. Available parts can be ordered from place of purchase. Use exact wording from diagrams when ordering parts.

Hazardous substance

Part name		Mercury (Hg)	Cadmium (Cd)	Hexavalent Chromium (CrVi)	Polybrominated biphenyls (CrVi)	Polybrominated diphenyl ethers (PBDE)
Cord set	×	○	○	○	○	○
Lamp holder	×	○	○	○	○	○

This table is prepared according to provisions of SJ/T 11364.

○: Indicates that said hazardous substance contained in all of the homogeneous materials for this part is below the limit requirement of GB/T 26572.

×: Indicates that said hazardous substance contained in at least one of the homogeneous materials for this part above the limit requirement of GB/T 26572.

**"We followed the light to a brighter
and warmer place."**