



WHAT'S INSIDE MATTERS<sup>®</sup>

# M1200

ULTIMATE CLEANING POWER WITH  
**MO2OR™** DUAL INTAKE SYSTEM

**OWNER'S  
MANUAL**





## Getting Started

Important Safety Instructions .....	2
Polarization Instructions .....	3
State of California Proposition 65 Warnings .....	3
Description of the Vacuum .....	4
Assembling the Vacuum .....	6
Unwinding the Power Cord .....	6

## Operation

Reclining the Handle .....	7
Vacuumping Carpet .....	7
Vacuumping Hard Surfaces .....	7
Brushroll Auto Shut-off Feature .....	7
Carpet Height Adjustment .....	8
Vacuumping Under Furniture .....	9
Carrying the Vacuum .....	9

## Attachment Cleaning

Wand Cleaning .....	10
Cleaning Tools .....	11
Adjusting the Suction Power .....	12
Disconnecting the Hose .....	12

## Maintenance And Care

Annual Checkup .....	13
Power Cord Care.....	13
When to Change the Vacuum Bag .....	13
Replacing the Vacuum Bag .....	14
When to Change the Filters .....	15
Replacing the HEPA Media Filter .....	15
Replacing the Charcoal Filter .....	16
Replacing the Direct Air Motor Filter .....	17
Lifetime Belt .....	17
Jammed Brushroll .....	18
Thermal Motor Protection .....	19

## Problem Solving Guide

Troubleshooting .....	20
Visit Maytag Vacuums Online .....	20
Telephone Customer Support .....	20
Key Replacement Parts .....	20
For Best Performance .....	20

Warranty .....	21
----------------	----

# IMPORTANT SAFETY INSTRUCTIONS

---

When using an electrical appliance, basic precautions should always be followed, including the following:

## READ ALL INSTRUCTIONS BEFORE USING THIS APPLIANCE

**IMPORTANT:** The manufacturer cannot accept responsibility for damage caused when the appliance is not used according to the instructions, or for uses other than those for which it was intended.

### To reduce the risk of fire, electric shock or injury:

- Do not leave appliance when plugged in. Unplug from outlet when not in use and before servicing.
- Do not use outdoors or on wet surfaces.
- Do not allow to be used as a toy. Close attention is necessary when used by or near children.
- Use only as described in this manual. Use only manufacturer's recommended attachments.
- Do not use with damaged cord or plug. If appliance is not working as it should, has been dropped, damaged, left outdoors, or dropped into water, return it to your Authorized Maytag Vacuum Service Center for service.
- Do not pull or carry by cord, use cord as a handle, close a door on the cord, or pull cord around sharp edges or corners. Do not run appliance over cord. Keep cord away from heated surfaces.
- Do not unplug by pulling on cord. To unplug, grasp the plug, not the cord.
- Do not handle plug or appliance with wet hands.
- Do not put any object into openings. Do not use with any opening blocked; keep free of dust, lint, hair and anything that may reduce air flow.
- Keep hair, loose clothing, fingers and all parts of body away from openings and moving parts.
- Do not pick up anything that is burning or smoking, such as cigarettes, matches or hot ashes.
- Do not use without vacuum bag and/or filters in place.
- Turn off all controls before unplugging.
- Use extra care when cleaning on stairs.
- Do not use to pick up flammable or combustible liquids such as gasoline or use in areas where they may be present.
- Do not attempt to service the unit while appliance is plugged in.

**SAVE THESE INSTRUCTIONS.**

# POLARIZATION INSTRUCTIONS

---

## Power Cord, 2-Wire Polarized Cord

To reduce the risk of electric shock, this product is equipped with a polarized alternating current line plug (a plug having one blade wider than the other). This plug will fit into the power outlet only one way. This is a safety feature. If you are unable to insert the plug fully into the outlet, try reversing the plug. If the plug should still fail to fit, contact a qualified electrician to replace the obsolete outlet. Do not defeat the safety purpose of the polarized plug.

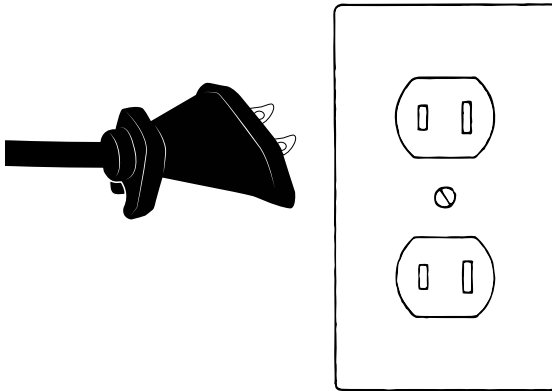

## State of California Proposition 65 Warnings:

WARNING: This product contains one or more chemicals known to the State of California to cause cancer.

WARNING: This product contains one or more chemicals known to the State of California to cause birth defects or other reproductive harm.

# DESCRIPTION OF THE VACUUM

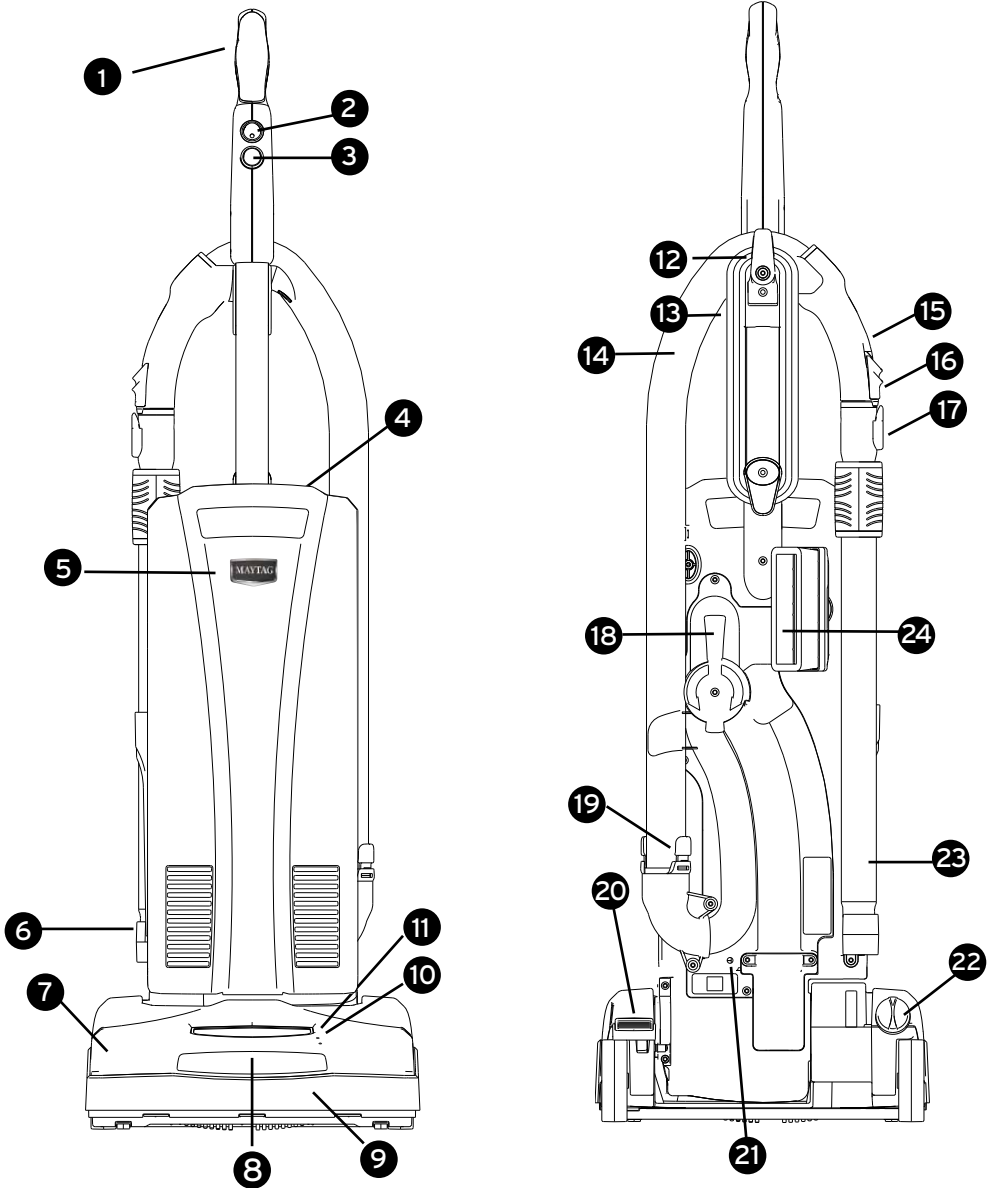

# DESCRIPTION OF THE VACUUM

---

- 1 Ergonomic Handle
- 2 Main On / Off Power Switch
- 3 Carpet Button
- 4 Carrying Handle
- 5 Bag Compartment Latch (to Replace Vacuum Bag and Filters)
- 6 Crevice Tool
- 7 Vacuum Nozzle
- 8 LED Headlights
- 9 Furniture Guard
- 10 Brushroll Jam Indicator
- 11 Full Bag / Clog Indicator
- 12 Quick Release Upper Cord Hook
- 13 Power Cord
- 14 Stretch Hose
- 15 Hose Handle
- 16 Suction Release Valve
- 17 Wand Release Button
- 18 Tool Activation Dial
- 19 Hose Disconnect Cuff
- 20 Handle Release Pedal
- 21 Thermal Motor Protection Reset Button
- 22 Carpet Height Adjustment Dial
- 23 Telescopic Wand
- 24 Combination Dusting / Upholstery Brush

# ASSEMBLING THE VACUUM

## Attaching the Handle to the Vacuum

NOTE: Do not plug in the vacuum until it is completely assembled.

The vacuum cleaner and the handle are packed separately and require assembly.

- Remove the handle screw located on the back of the vacuum (Fig. 1). Insert the handle downward into the body of the vacuum (Fig. 2). Insert screw and tighten.
- Open the bag compartment cover to ensure a vacuum bag is in place.
- Your vacuum is now ready for use.
- If storing the vacuum, wrap the cord clockwise around the top and bottom cord hooks. Fasten the plug to the wrapped cord using the channel on the plug.

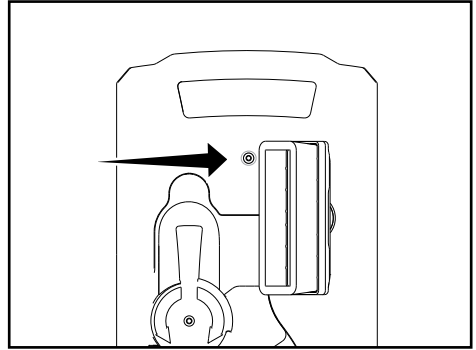

Fig. 1

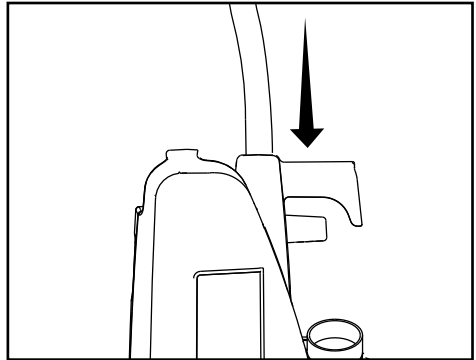

Fig. 2

## Unwinding the Power Cord

- The Quick Release Upper Cord Hook rotates to allow for quick access to the power cord. Turn the upper cord hook downward and you can quickly drop the power cord to the floor without unwinding it from the cord hooks (Fig. 3).
- When storing the vacuum cleaner, turn the Quick Release Upper Cord Hook to the upright position and wrap the power cord around the cord storage hooks.

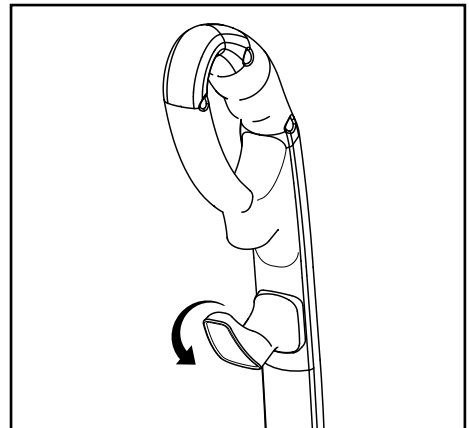

Fig. 3



This vacuum is intended for household use only.

## Reclining the Handle

Press the Handle Release Pedal with your foot to recline the handle.

## Vacuuming Carpet

For carpet cleaning, push the On / Off Switch to the "On" position. The Carpet Button will illuminate indicating the carpet cleaning setting is on (Fig. 1). The carpet cleaning setting will remain on until the Carpet Button is pushed and the button is no longer illuminated.

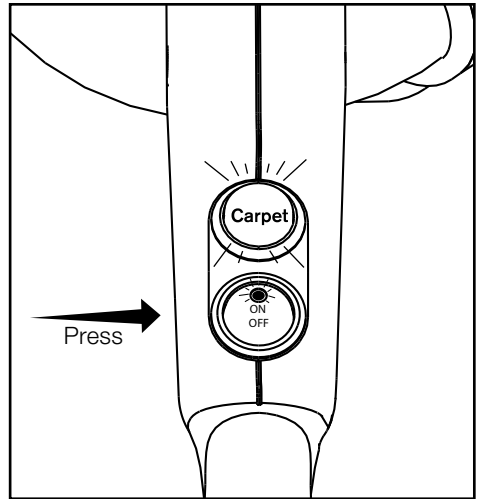

Carpet Cleaning  
Fig. 1

## Vacuuming Hard Surfaces

For bare floor cleaning (i.e. tile, wood, or vinyl), push the On / Off Switch to the "On" position. Push the Carpet Button. The Carpet Button will no longer be illuminated indicating the carpet setting is off and the bare floor setting is on (Fig. 2).

## Brushroll Auto Shut-Off Feature

When the vacuum is turned on and in the upright position, the brushroll will not spin to reduce the possibility of damaging floor surfaces. The brushroll will spin when the handle is lowered, if the Carpet Button is illuminated.

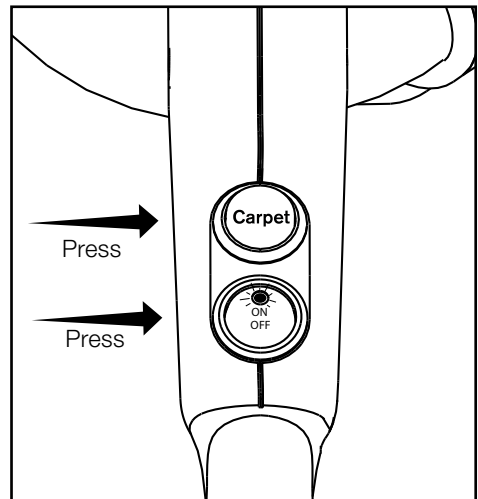

Bare Floor Cleaning (Wood, Tile, etc.)  
Fig. 2

Always turn the vacuum cleaner off before unplugging it from the electrical outlet.

# OPERATION

---

## Carpet Height Adjustment

There are six carpet height settings designed for numerous flooring surfaces.

Locate the height adjustment dial just above the right rear wheel, and rotate the dial to the desired height.

<b>Max</b>	Shag/Frieze or similar length carpet
<b>X Hi</b>	Plush carpet
<b>High</b>	Medium pile carpet
<b>Auto</b>	General setting
<b>Floor</b>	Hard floors
<b>Low</b>	Low pile carpet

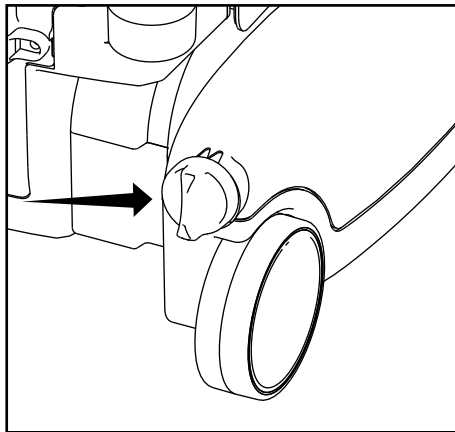

If it becomes difficult to push the vacuum across the carpet, adjust the dial to a higher carpet setting.

## Vacuuming Under Furniture

Your vacuum will lay flat on the floor for effective cleaning under beds and tables.

- Press the Handle Release Pedal once for normal vacuuming (Fig. 1).
- Press the Handle Release Pedal a second time to enable the vacuum to lay flat on the floor (Fig. 2).

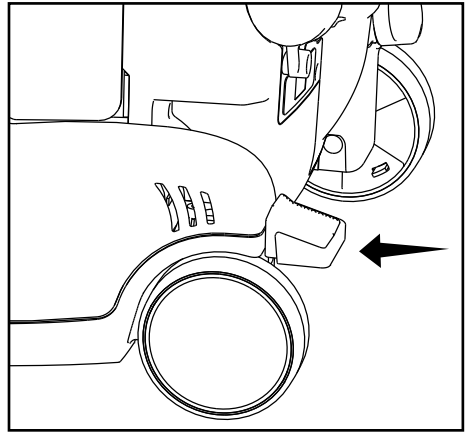

Fig. 1

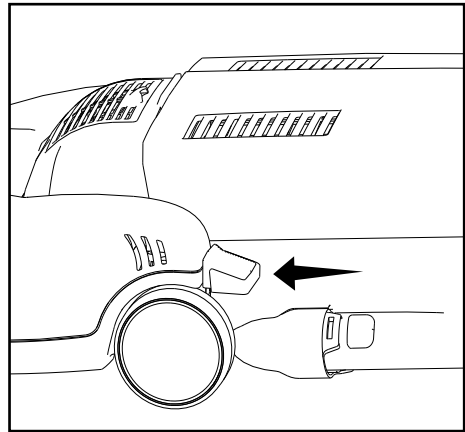

Fig. 2

## Carrying the Vacuum

To safely transport your vacuum, especially when carrying the vacuum up and down stairs, use the Carrying Handle located at the top of the bag compartment (Fig. 3).

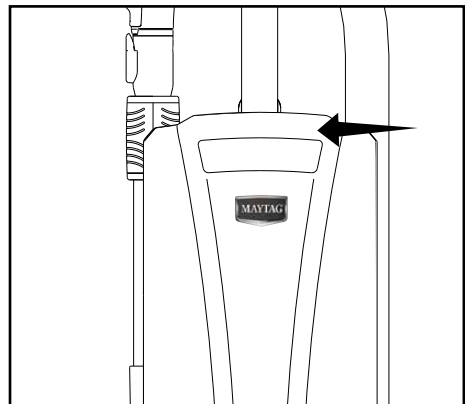

Fig. 3

# ATTACHMENT CLEANING

## Wand Cleaning

Your vacuum is a comprehensive cleaning system equipped with an upholstery tool, dusting brush, crevice tool, telescopic wand and a stretch hose.

- Remove the Telescopic Wand from the body of the vacuum by pulling it up and out of the holder (Fig. 1).
- Turn the Tool Activation Dial counter-clockwise to the "Tools On" setting (Fig. 2). The Telescopic Wand is now activated for quick cleaning.
- Extend the wand by grasping the wand cuff and pushing outward to the desired length (Fig. 3).
- Attach any of the tools to the end of the Telescopic Wand.
- When finished with tool / wand cleaning, turn the Tool Activation Dial clockwise to the "Tools Off" setting (Fig. 4). Insert the wand back into the vacuum and secure it by pushing the curved handle into the holder.

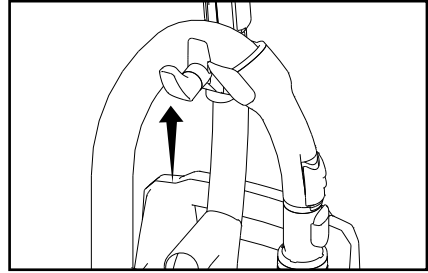
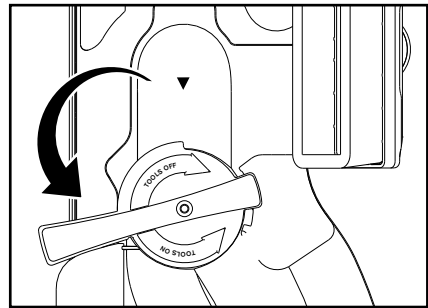

Fig. 1



Tools On  
Fig. 2

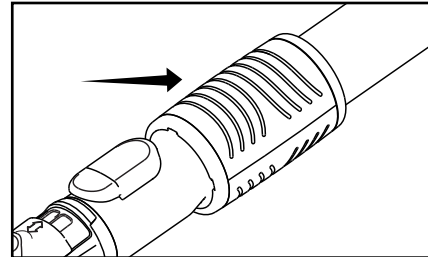
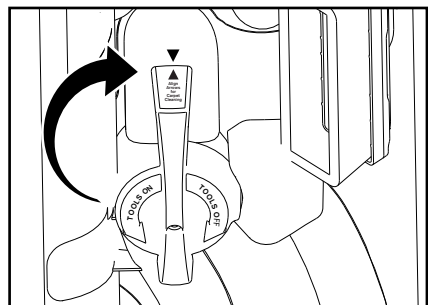

Fig. 3



Tools Off  
Fig. 4

## Cleaning Tools

Your vacuum is equipped with a dusting brush, upholstery brush and crevice tool.

- Remove the Telescopic Wand from the vacuum and turn the Tool Activation Dial to the "Tools On" setting. (See page 10)
- Attach any of the tools onto the end of the wand (Fig. 1).

## Dusting Brush

Ideal for table tops, shelves, blinds or hard surface floors.

## Crevice Tool

Ideal for tight places like between seat cushions or corners.

## Upholstery Tool

Ideal for soft surfaces like chairs and couches. Remove the dusting brush clip for upholstery cleaning.

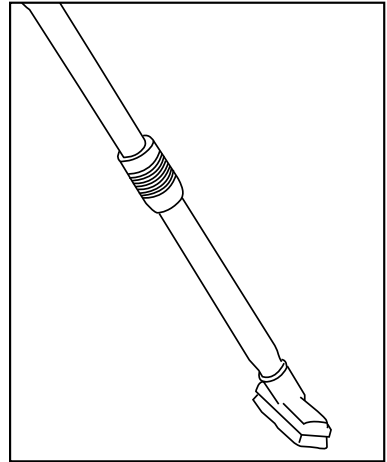
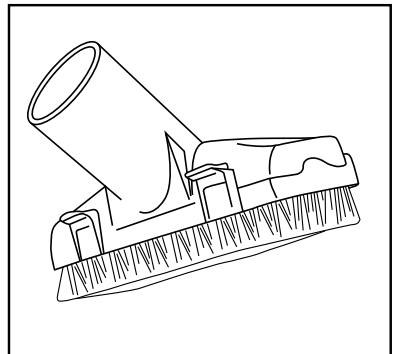
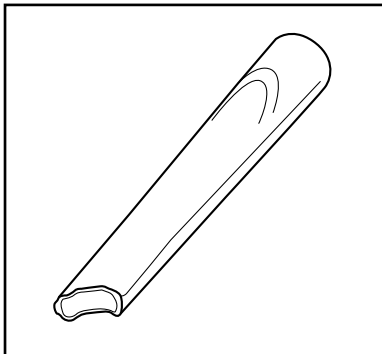

Fig. 1



Dusting Brush



Crevice Tool

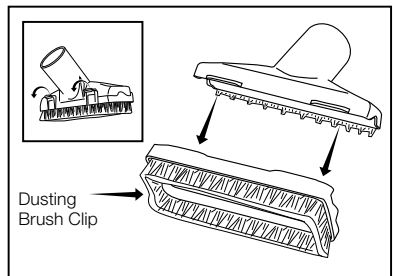

Upholstery Brush

# ATTACHMENT CLEANING

## Cleaning Tools (continued)

Cleaning tools can also be attached to the curved handle for tasks where the wand is not needed.

- Disconnect the wand from the curved handle by pressing the Wand Release Button (Fig. 1).
- Attach any of the cleaning tools directly to the curved handle.

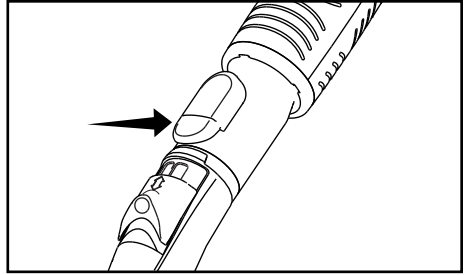

Fig. 1

## Adjusting the Suction Power for Tool Cleaning

Full suction power may be too strong for some cleaning situations. For example, reduced suction power would be appropriate for cleaning sheer curtains.

- On the curved handle, locate the Suction Relief Valve and slide it backward (Fig. 2). This reduces the suction power coming through the tool. Slide the valve forward when finished to restore full suction power.

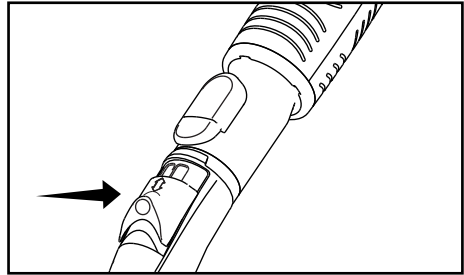

Fig. 2

## Disconnecting the Hose

The hose can be disconnected from the vacuum by pressing the two buttons on the sides of the Hose Disconnect Cuff located low on the back of the vacuum (Fig. 3).

This allows you to attach an optional extension hose for longer reach and is also a method for removing debris from the hose.

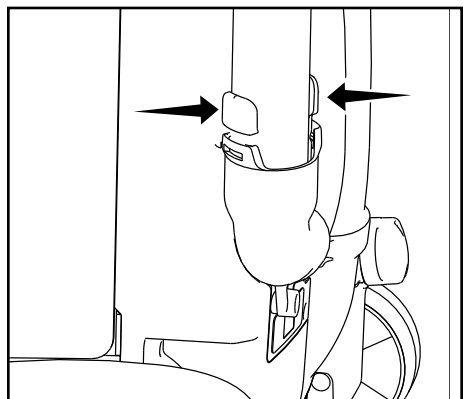

Fig. 3

## Annual Checkup

To keep your vacuum in peak operating condition, it is recommended you bring your vacuum to an Authorized Maytag Vacuum Service Center for an annual checkup. The Service Center will conduct a comprehensive examination to ensure your vacuum is in top operating condition.

## Power Cord Care

- If the cord or plug has any apparent damage, refrain from using the vacuum. Please visit an Authorized Maytag Vacuum Service Center for a new cord or plug.
- When the vacuum is in use, hold the cord to keep from running over it.
- Avoid obstructions and do not pull the cord around sharp edges or corners.
- Always keep the cord away from heated surfaces and never close doors on it as this may cause damage to the wiring.
- To unplug, always grasp the plug, not the cord.

## When to Change the Vacuum Bag

The Full Bag Indicator Light is designed to show when the bag is full or when there is a clog in the vacuum.

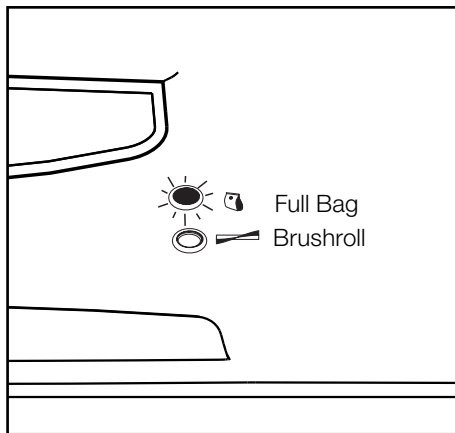

Yellow Warning Light Indicates a Full Bag Condition

The light could also come on when vacuuming fine powders such as flour or drywall dust. These materials can quickly block the bag pores, significantly reducing airflow before the bag is actually full. The vacuum bag should still be changed.

The light may also come on during attachment cleaning. If the light goes off when attachments are no longer in use, the vacuum bag does not need to be changed.

Note: The vacuum bags are disposable and intended to only be used once. Do not attempt to reuse the bag, as suction and filtration performance will be greatly reduced.

# MAINTENANCE AND CARE

## Replacing the Vacuum Bag

**NOTE:** Unplug the vacuum cleaner from the electrical outlet before changing the bag.

- Open the bag compartment by lifting up the latch on the bag compartment cover.
- Remove the used vacuum bag by pulling the blue bag collar tab away from the vacuum (Fig. 1). Slide the used bag out of the holder which automatically seals the bag (Fig 2). Discard the used bag.
- To install a new bag, slide the bottom of the blue bag collar into the bag holder until it “snaps” into place (Fig. 3).
- Push the top of the bag collar upward until the bag holder “snaps” into place on the vacuum (Fig. 4).
- Tuck the bag corners into the bag compartment before replacing the bag compartment cover.
- Replace the bag compartment cover and press down on the latch to secure it into place.

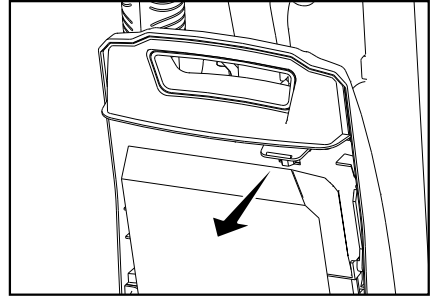

Fig. 1

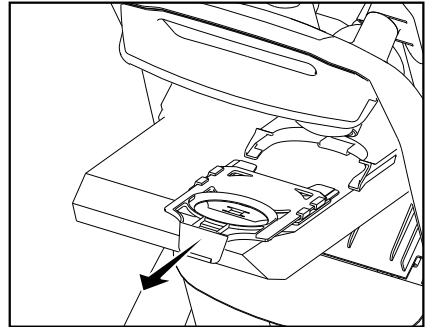

Fig. 2

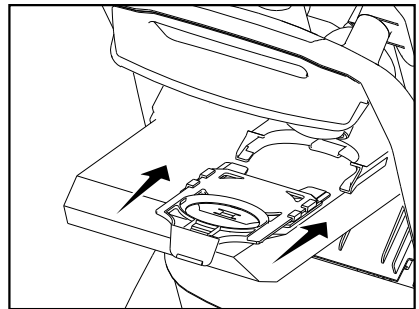

Fig. 3

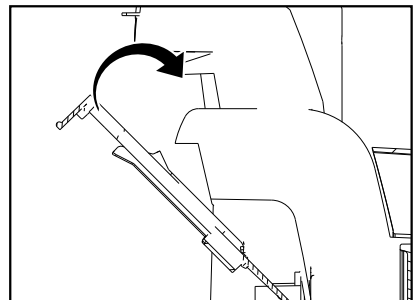

Fig. 4



## When to Change the Filters

**NOTE:** Unplug the vacuum cleaner from the electrical outlet before changing the filters.

At minimum, it's recommended to replace the filters once a year or after using twelve vacuum bags, whichever comes first.

If someone in your household is sensitive to airborne allergens, it is recommended to change the filters after every six vacuum bags.

## Replacing the HEPA Media Filter

- Remove the bag compartment cover.
- Locate the HEPA Media Filter on the front of the vacuum.
- Grasp the tab on the left to remove the used filter and discard it. **NOTE:** Filters cannot be washed and reused.
- To insert a new filter, position the tabs on the right side of the cartridge into the vacuum. Then snap it into place.
- Replace the bag compartment cover and press down on the latch to secure it into place.

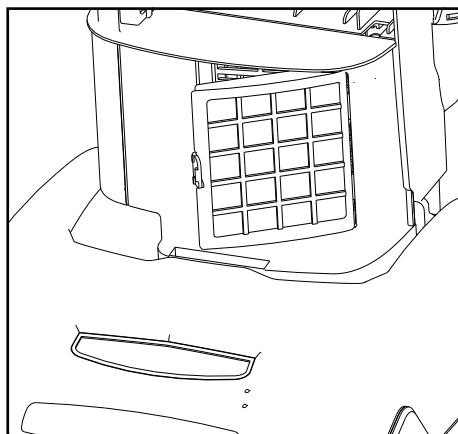

# MAINTENANCE AND CARE

---

## Replacing the Charcoal Filter

- Remove the bag compartment cover and locate the filter on the left side of the bag compartment.
- Pull the front tab away from the vacuum to remove the filter holder (Fig. 1).
- Remove and discard the used Charcoal Filter.  
NOTE: Filters cannot be washed and reused.
- Insert a new Charcoal Filter under the tabs in the holder. Then align the back of the filter holder into the vacuum first and snap it into place behind the tab.
- Replace the bag compartment cover and press down on the latch to secure it into place.

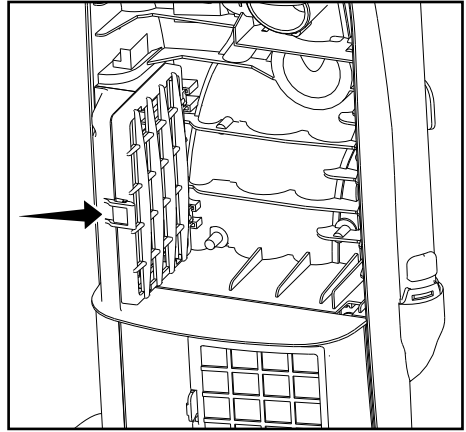

Fig. 1

## Replacing the Direct Air Motor Filter

- Press the handle release pedal with your foot, and tilt the handle back until it stops. Press the pedal again to lower the handle to the floor (Fig. 1).
- Pull the black filter cover latch to access the filter (Fig. 2).
- Remove and discard the used filter.
- Insert a new direct air motor filter and snap the filter cover back into place.
- Return vacuum handle to its upright position.

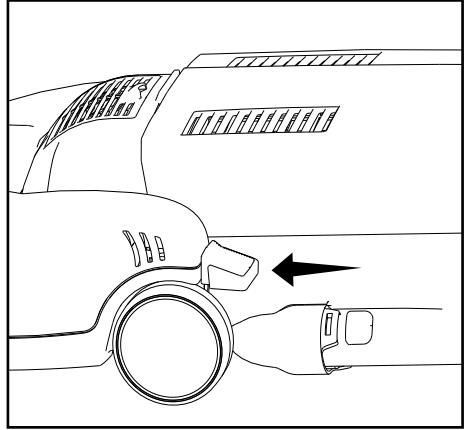

Fig. 1

## Lifetime Belt

Your vacuum belt is covered with a lifetime warranty. Should the vacuum belt break, simply bring your vacuum to your Authorized Maytag Vacuum Service Center for a free replacement.

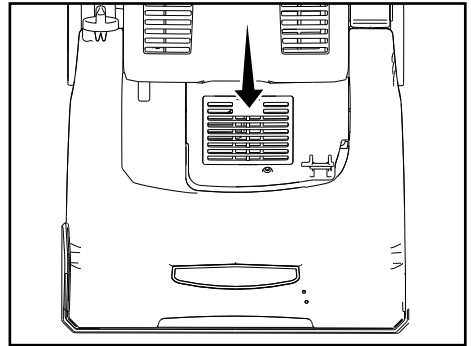

Fig. 2

# MAINTENANCE AND CARE

---

## Jammed Brushroll

**CAUTION!** To Reduce the Risk of Injury From Moving Parts, Unplug Before Servicing.

If an object, such as a throw rug or article of clothing is ever picked up into your vacuum, the vacuum will sense this Jammed Brushroll condition and turn off the brushroll. When this happens, the Brushroll Warning light on the top of the nozzle will light up in red.

- Turn off and unplug the vacuum.
- Remove the cause of the jam.
- Turn the vacuum back on.
- If the brushroll is free of any object and the Brushroll Warning light is still lit, it's likely the clogged condition is located in the vacuum motor fan. If so, please take it to an Authorized Maytag Vacuum Service Center for service.

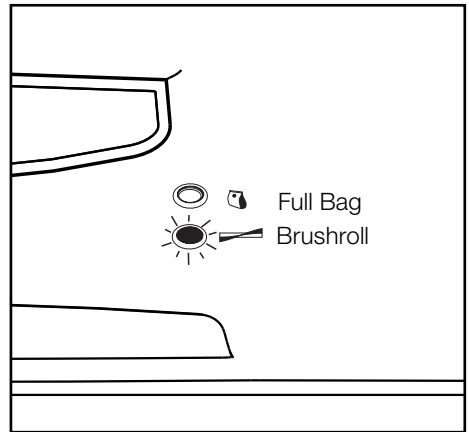

Red Warning Light Indicates a Jammed Brushroll Condition

## Thermal Motor Protection

**CAUTION!** To Reduce the Risk of Injury From Moving Parts, Unplug Before Servicing.

Your vacuum is equipped with a safeguard to recognize when the vacuum might overheat and shuts itself off. When this happens the headlights are still on but the motors shut off. Common reasons why a vacuum may overheat include operating with a full bag or when there is a clog in the vacuum.

If the Thermal Motor Protection System shuts off your vacuum, follow these steps:

- Unplug the vacuum.
- Inspect the vacuum for a full bag condition or a hose clog and correct the problem.
- Locate the Thermal Motor Protection Reset Button on the back of the vacuum. Press the button and resume vacuuming.

If problem continues, contact your Authorized Maytag Service Center.

Thermal Reset	
1. Unplug machine	3. Correct problem
2. Locate problem source (clogged hose or full bag)	4. Press reset button
If problem persists, consult owner's manual or contact retailer.	

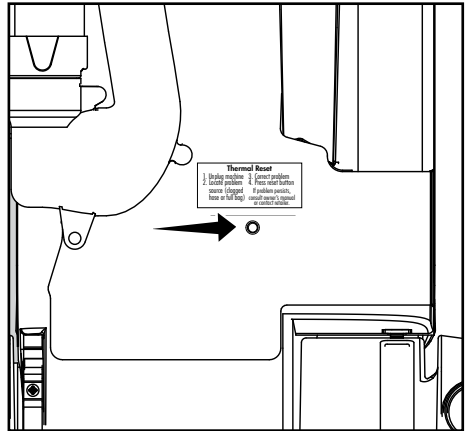

# PROBLEM SOLVING GUIDE

## Troubleshooting

**CAUTION!** To reduce the risk of injury from moving parts, unplug the vacuum before servicing.

**CAUTION!** To reduce the risk of electric shock, do not handle plug or appliance with wet hands.

PROBLEM	POSSIBLE REASON	POSSIBLE SOLUTION
Vacuum won't turn on	<ul style="list-style-type: none"><li>• Power cord not firmly plugged in.</li><li>• Blown fuse or tripped breaker.</li><li>• Needs service.</li></ul>	<ul style="list-style-type: none"><li>• Plug unit in firmly.</li><li>• Check house fuse or breaker. Replace fuse / reset breaker.</li><li>• Take to an Authorized Maytag Service Center.</li></ul>
Vacuum won't pick up or low suction	<ul style="list-style-type: none"><li>• "Carpet" button not on.</li><li>• Vacuum bag is full.</li><li>• Clogged filter(s).</li><li>• Hose clogged.</li><li>• Worn brushes.</li><li>• Broken belt.</li><li>• Tool Activation Dial turned "On".</li></ul>	<ul style="list-style-type: none"><li>• Press "Carpet" button on – it will illuminate when it's on.</li><li>• Replace bag.</li><li>• Replace filter(s).</li><li>• Remove obstacle.</li><li>• Replace brush strips.</li><li>• Take to an Authorized Maytag Service Center.</li><li>• Turn Tool Activation Dial to "Off" position for carpet or bare floor cleaning.</li></ul>
Dust escaping from vacuum	<ul style="list-style-type: none"><li>• Dust compartment cover not attached properly.</li><li>• Filters not installed correctly.</li></ul>	<ul style="list-style-type: none"><li>• Attach the dust compartment cover and secure latch.</li><li>• Review filter installation (page 15-17).</li></ul>

Any other service should be done by an Authorized Maytag Vacuum Service Center. To locate your nearest service center, visit our website at [www.MaytagVacuums.com](http://www.MaytagVacuums.com). For telephone customer support please call **1-855-653-1114**.

## Key Replacement Parts

- Genuine HEPA Media Vacuum Bags: **M12H-6**
- Genuine Filter Set: **M12F**

## For Best Performance

- Keep your vacuum clean and in good operating condition.
- Change vacuum bags once a month or when the full bag light is illuminated to maximize cleaning performance.
- Always use genuine Maytag™ vacuum bags and replacement parts. Use of other products may result in poor cleaning performance, potential vacuum cleaner damage and may void vacuum warranty. Genuine products are designed for maximum cleaning performance.
- Have your vacuum checked annually by your Authorized Maytag Service Center.
- Store your vacuum carefully in a dry area.
- For optimum cleaning performance and safety, follow your owner's manual instructions.

**What is Covered:**

This warranty covers any defects in material and workmanship in your new Maytag™ vacuum and applies exclusively to the original purchaser.

**How Long Coverage Lasts:**

Warranty coverage for your vacuum lasts five years. Household models used commercially are only warranted for 90 days.

**What is Not Covered:**

- Damage to the vacuum which occurs from neglect, abuse, alterations, accident, misuse or improper maintenance.
- Normal replacement items: disposable bags, disposable filters, and agitator brushes.

**What We Will Do:**

This warranty provides, at no cost to you, all labor and parts to keep this vacuum in correct operating condition during the warranted period.

**How to Get Service:**

Warranty service can only be obtained by presenting the vacuum to an Authorized Maytag Vacuum Service Center. A proof-of-purchase and product serial number will be required before service is rendered. To locate your nearest service center, please call 1-855-653-1114 or visit [www.MaytagVacuums.com](http://www.MaytagVacuums.com).

THIS WARRANTY IS EXCLUSIVE AND IN LIEU OF ANY AND ALL OTHER WARRANTIES WHETHER WRITTEN, ORAL, EXPRESSED OR IMPLIED, (INCLUDING ANY WARRANTY OF MERCHANTABILITY OR FITNESS FOR A PARTICULAR PURPOSE). THIS WARRANTY DISCLAIMS LIABILITY FOR INCIDENTAL, OR CONSEQUENTIAL DAMAGES.

**How State Law Applies:**

This warranty gives you specific legal rights, and you may also have other rights which vary from state to state.

Register your warranty online at [www.MaytagVacuums.com](http://www.MaytagVacuums.com)

# OWNER'S WARRANTY INFORMATION

---

*keep this for your records...*

Date of purchase \_\_\_\_\_

Serial number \_\_\_\_\_

Model number \_\_\_\_\_

**Purchased from:**

Store name \_\_\_\_\_

Address \_\_\_\_\_

City, State, Zip \_\_\_\_\_

Telephone \_\_\_\_\_











**WHAT'S INSIDE MATTERS®**

**MAYTAG™ VACUUMS**

**1-855-653-1114**

**[www.MaytagVacuums.com](http://www.MaytagVacuums.com)**