

INSTALLATION | WOOD POST ANCHOR 6x6 | Softwood

IMPORTANT

- !** Do not use on surfaces 30" or higher (U.S.A.) or 600mm / 23.62" (CAN) or higher **UNLESS** you build according to our Engineering Reports (See QR link below) **AND** obtain approval by your local authority.
- !** Use only Stainless Steel Screws with Aluminum Decking. Sold Separately.

1

No knots in the lower 4" - 6" (10-15 cm) of the post.

1-7/8"

TITAN WOOD POST ANCHOR™ KIT

(8) *Wood Screw #14X4" T27 Drive

(6) Lag Screw 1/2" X 5"*

**Concrete screws sold separately.*

RECOMMENDED TOOLS

Socket 9/16" (14 mm)	3 lbs. Hammer
Ratchet or Drill	Hole Saw 1-3/4" (45 mm) dia.
T27 Driver Bit	Forstner Bit Hardwood Installations Only

2

1-7/8"

4-3/4"

POST BRACE

RECOMMENDED ACCESSORY
WHEREVER EXTRA STRENGTH IS DESIRED

POST BRACE DETAIL

2x12
2x12
2x8
11-1/2"

3

DRILL

PRE-DRILL LAG SCREW TIP

4" DEEP MIN.

3/8" BIT 1/2" LAG

USE A 3/8" BIT AND PRE-DRILL AT LEAST 4" DEEP BEFORE INSTALLING 1/2" LAG SCREWS.

LAG SCREW | DRILL BIT GUIDE

SOFTWOOD POST	
3/8" LAG SCREW	5/16" DRILL BIT
1/2" LAG SCREW	7/16" DRILL BIT
HARDWOOD POST	
3/8" LAG SCREW	11/32" DRILL BIT
1/2" LAG SCREW	15/32" DRILL BIT

RECOMMENDED* ENGINEERED OPTION

(6) 1/2" X 5" LAG SCREWS
*Intertek 103643197TOR-005

4

BLOCKING (12) #10 X 3-1/2" **SPF**

5/4 Decking

2 x 12

2 x 8

! FOR VERY DRY WOOD, WET ENDS OF POST WITH WATER BEFORE USE TO PREVENT CRACKING.

ENGINEERING REPORTS FOR APPLICATION SUITABILITY

ATTENTION

- Do not use this product for residential code guard rails **UNLESS** you have a local engineer or inspector approve your application in your area. Do not use with cable rail, vinyl rail systems or as free standing post.
- Intertek engineering reports are for guidance only and complying with them **does not necessarily** mean your structure will be code compliant. Any variation from the assemblies tested in our engineering reports is outside of the scope of the report.
- This product is not for industrial, commercial or apartment building applications. It is for private residential use only.

WOOD POST ANCHOR / T1PR6612

INSTALLATION | WOOD POST ANCHOR 6x6 | *Hardwood*

IMPORTANT



Use only Stainless Steel Screws with Aluminum Decking. Sold Separately.

1

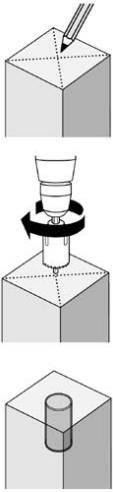

1-7/8"

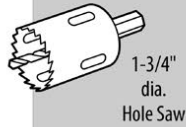

2-3/4"

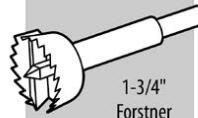

2-3/4"

2

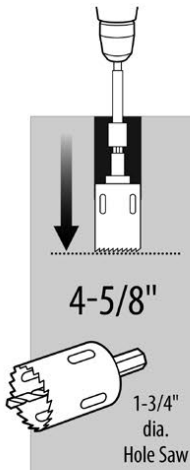

4-5/8"

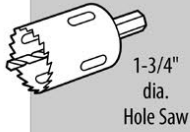

4-5/8"

3

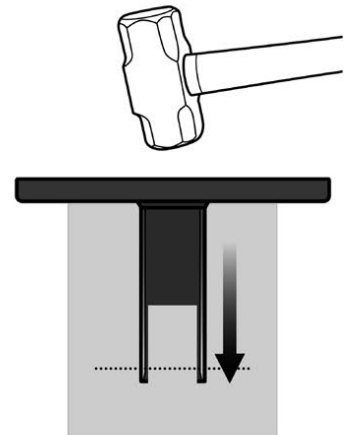

INSTALLATION | WOOD POST ANCHOR 6x6 | *Concrete*

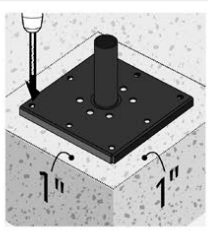

1

DRILL (1) CORNER HOLE & INSTALL (1) SCREW IN ANCHOR. DRILL (3) CORNER HOLES.
*Concrete screws sold separately. 1/4" x 2-1/4" min. screw size.

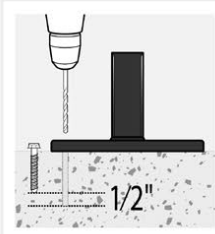

1/2"

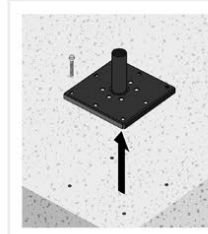
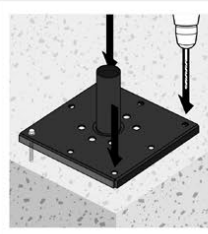
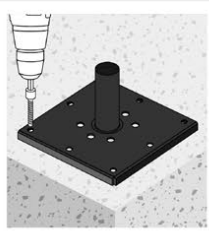

2

REMOVE ANCHOR. INSTALL REMAINING SCREWS. (With Wood Post)

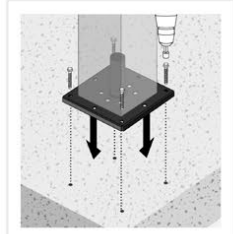

ATTENTION

This product is not for industrial, commercial or apartment building applications. It is for private residential use only. If you wish to use this product for any residential code application including a railing, engage local professionals before beginning work: (i) to ensure that this product is appropriate for your intended use and that the structural components which this product is to be used in conjunction with are sound and that the work area is safe and free from all potential hazards including utilities and other services, (ii) to provide clarification if these warnings are unclear or you do not understand any of the information in the installation instructions for this product. Always comply with applicable building codes. Be aware that building codes may vary.

When using tools always comply with the applicable user manuals and instructions. Everyone in the vicinity of any work area must wear appropriate protective gear including gloves, footwear, eyewear, hardhat and appropriate clothing. Inspect and maintain these products and the structural components that they are used in connection with on a regular basis using professionals when appropriate. Always work in a safe manner.

In no event shall Titan Building Products be liable for any loss or damage, direct or otherwise, which results from the improper use of this product. If for any reason Titan Building Products becomes liable for loss or damage, direct or otherwise the aggregate liability of Titan Building Products shall be limited to the retail purchase price of the products.

WOOD POST ANCHOR / TIPR6612

1-866-577-8868

TITAN BUILDING PRODUCTS
THE ART OF BUILDING
More Outdoor Beauty... Real easy.



www.titanbp.com