

INSTALLATION | DECK FOOT ANCHOR™

IMPORTANT



THIS PRODUCT IS DESIGNED FOR FREE-STANDING STRUCTURES. IT MAY NOT WORK IN YOUR SOIL. ROCKS, ROOTS OR A WEAK IMPACT WRENCH MAY PREVENT THE AUGER FROM DRIVING FULLY INTO THE SOIL. CONTINUOUS TORQUE, ONCE STOPPED BY AN OBSTRUCTION, CAN DESTROY THE AUGER. IMPROPERLY SIZED SOCKETS CAN STRIP THE DRIVER HEAD. DESIGNED FOR COMPRESSION LOAD APPLICATIONS ONLY.

1

Remove Sod and any organic material.

Add 2" - 3" of 1/2" Crushed Stone or Stone Dust Base

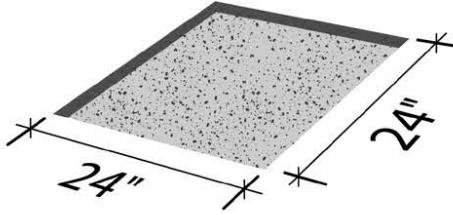

DECK FOOT ANCHOR™

M16 2.0 THREAD

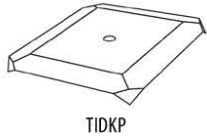

TIDKP

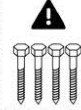

1/4 X 3" LAG SCREWS SOLD SEPARATELY

TIGA600 -or- TIGA900



TIDP442 -or- TIDP662

TOOLS NEEDED

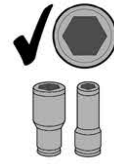

12 MM AND 24 MM, 6 POINT DEEP IMPACT SOCKET



350 FT-LBS. CORDED OR 18V CORDLESS 1/2" IMPACT WRENCH



12 POINT SOCKET



1/2"

2

Assemble parts

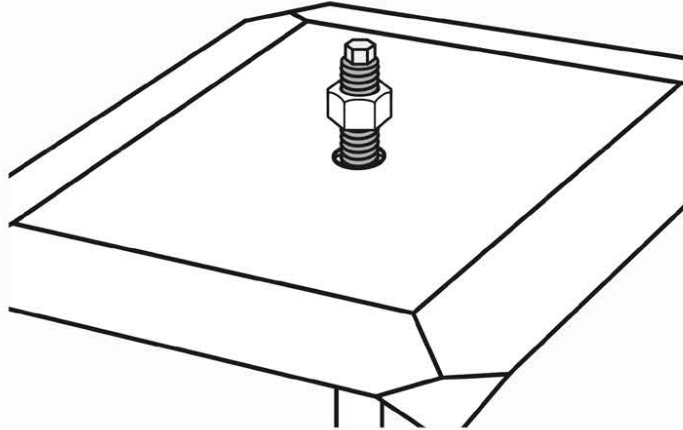
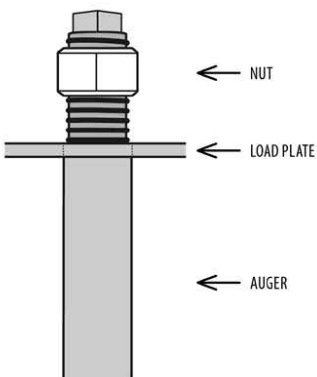

3

Drive Anchor down.

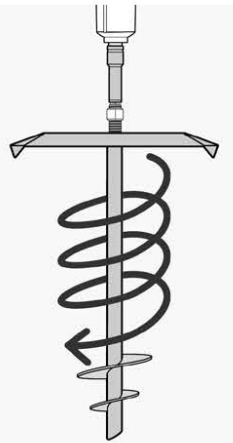

4



Set NUT about half way up threaded rod. Drive auger until top of plate contacts nut.

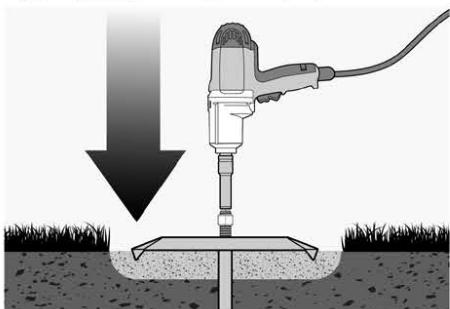

5

Drive NUT down fully to seat plate on auger tube.

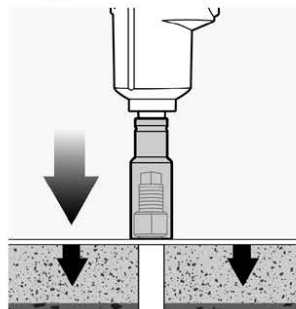

If installing BY HAND use the Hand Auger Tool or a Breaker Bar.

OPTION 1

OPTION 2

DIYers! HAND AUGER TOOL

24" BREAKER BAR

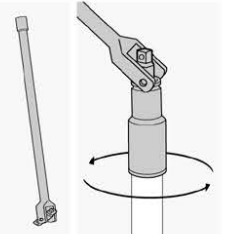
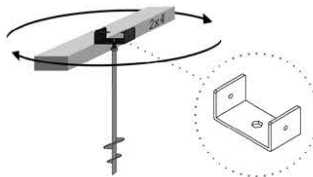

AT2035 Sold separately. Wood and fasteners not included.

6

Washer and Nut Combinations depend on height of nuts.

Adjust position before fastening.

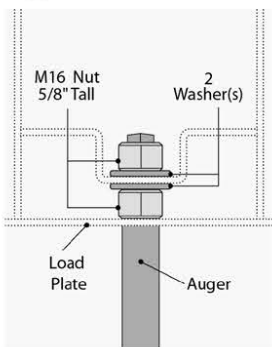

or

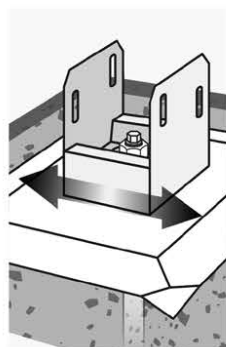
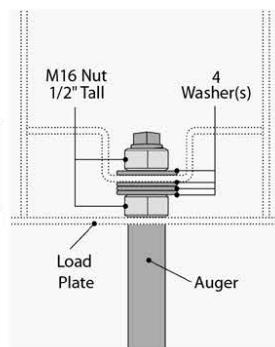

7A

Fasten Screws at the top for Intertek CCRR Standards.

7B

Fasten Screws at the bottom to use Terra-Shift™ Technology.

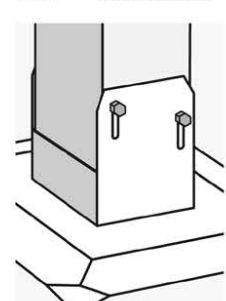

or

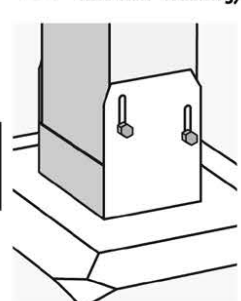

⚠ Stop as soon as screw contacts bracket.

ATTENTION



CHECK YOUR LOCAL BUILDING DEPARTMENT FOR HEIGHT RESTRICTIONS REGARDING FREE STANDING STRUCTURES.

REV: 12/20/23

ENGINEERING REPORTS FOR APPLICATION SUITABILITY



DECK FOOT ANCHOR™ / TIDP442 / TIDP662 / TIDKP / TIGA600 / TIGA900

PATENT NO

US 9,309,688

T 1-866-577-8868

TITAN BUILDING PRODUCTS®
THE ART OF BUILDING
More Outdoor Beauty... Real easy.



www.titanbp.com

INSTALLATION | DECK FOOT ANCHOR™

⚠ DO NOT ATTACH TO HOUSE

***Designed for non-ledger attached decks.**

*EXCEPTION ALLOWED WHERE GROUND DOES NOT FREEZE.
NOT RECOMMENDED FOR SECOND STOREY WALKOUT DECKS.
NOT INTENDED FOR FENCES OR OTHER STRUCTURES
REQUIRING LATERAL LOAD RESISTANCE.

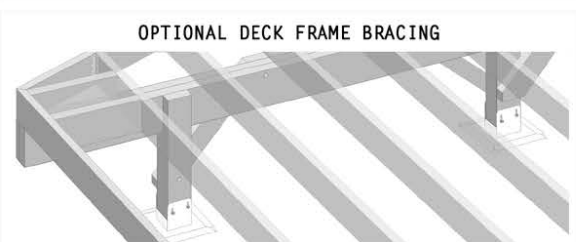
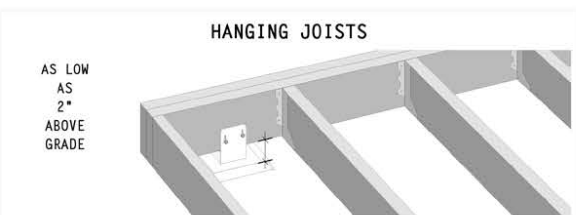
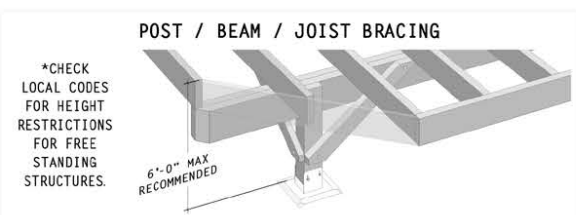
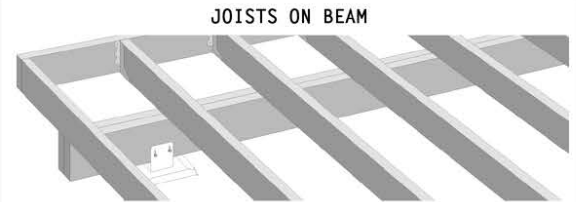
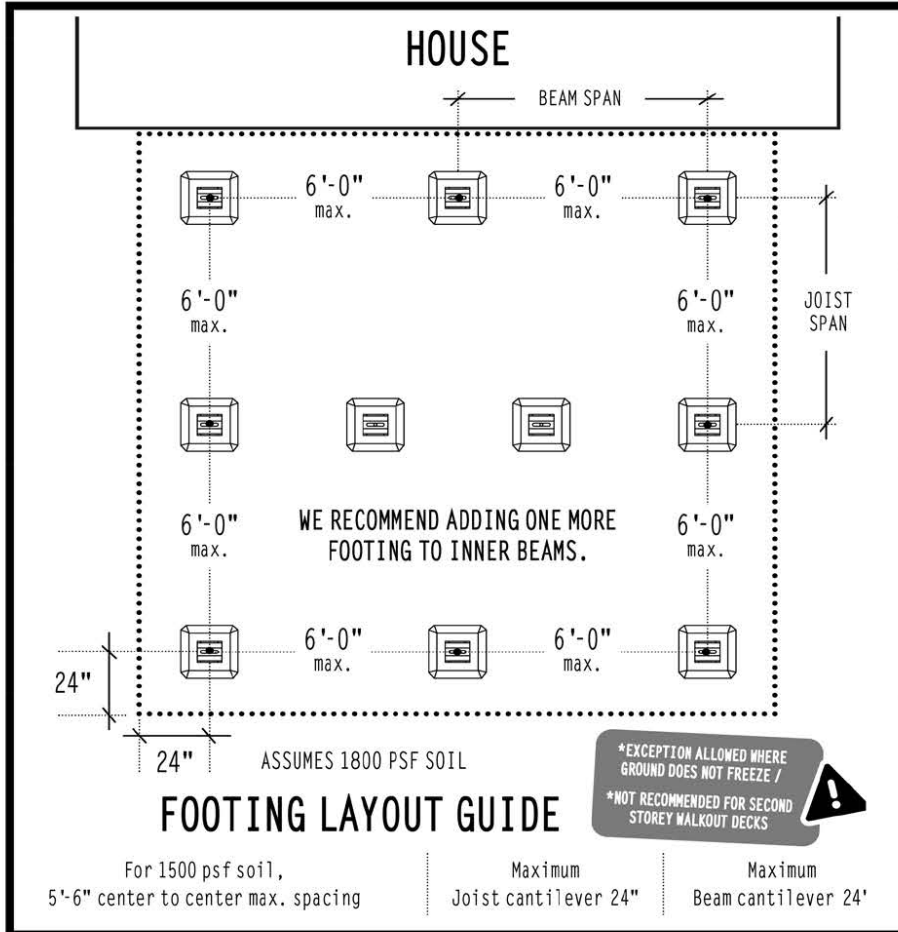
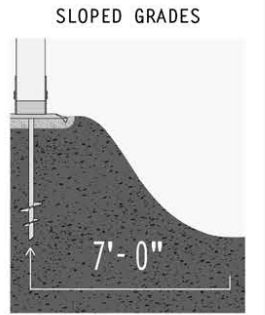
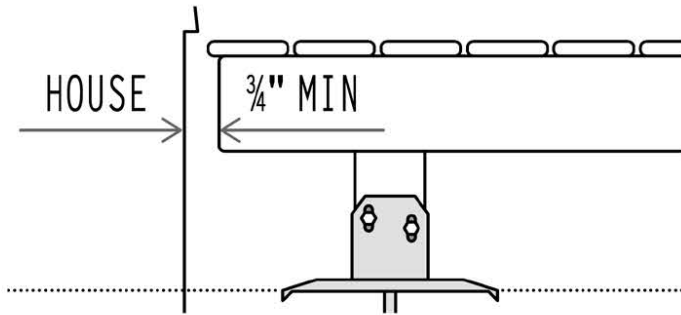

'A SHOCK ABSORBING SYSTEM FOR YOUR DECK'

TERRA-SHIFT™ Technology

The **Deck Foot Anchor™** uses our patented **Terra-Shift™ post bracket system** to help keep soil around the anchor undisturbed and prevent damage to all post and beam and other structural connections.

HERE IS HOW IT WORKS:

The fastener slide holes reduce friction between the post and bracket just enough so that if the soil shifts or expands unevenly along a series of footings under a beam, the post is free to slide vertically and then settle back to normal. It's like a shock absorbing system for your deck.

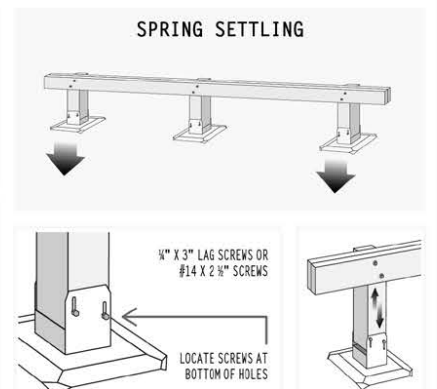
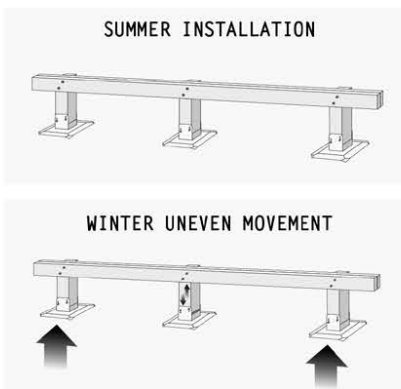

DECK FOOT ANCHOR™ / TIDP442 / TIDP662 / TIDKP / TIGA600 / TIGA900

PATENT NO

US 9,309,688

Titan Building Products
Deck Foot Anchor™



CODE COMPLIANCE
CCRR-0495

CERTIFIED TO:
IRC 2021, AC308
AC308, AC13, ASTM D1143, ASTM D3689

Consult the Design Listing for construction of the approved assembly

Refer to the Intertek Directory of Building Products (<https://bpdirectory.intertek.com>) for detailed information.

ATTENTION: Before beginning work, consult with local building officials or engage professionals to ensure that this product is appropriate for your intended use or help clarify if these warnings are unclear or if you do not understand any of the information in this installation guide. Always comply with applicable building codes and be advised that building codes may vary.

QUESTIONS? CONTACT US AT 1-866-577-8868 IN NO EVENT SHALL TITAN BUILDING PRODUCTS BE LIABLE FOR ANY LOSS OR DAMAGE, DIRECT OR OTHERWISE, WHICH RESULTS FROM THE IMPROPER INSTALLATION OR USE OF THIS PRODUCT. IF FOR ANY REASON TITAN BUILDING PRODUCTS BECOMES LIABLE FOR LOSS OR DAMAGE, DIRECT OR OTHERWISE, THE AGGREGATE LIABILITY OF TITAN BUILDING PRODUCTS SHALL BE LIMITED TO THE RETAIL PURCHASE PRICE OF THE PRODUCTS.

T 1-866-577-8868

TITAN BUILDING PRODUCTS
THE ART OF BUILDING
More Outdoor Beauty... Real easy.



www.titanbp.com