

PID
FLOORS

VOLUME 3

PID Floors

A family-run company founded in 1989. A destination for style, luxury, sustainability, and service with love. We are family and so are you.



OUR STORY

OUR IDEALS

OUR HISTORY

OUR COMMITMENT

12 To the Environment and to You

13 Participation

14 Standards and Certifications

15 Green Building Certifications

17 Partnerships

OUR PORTFOLIO

22 Commercial

28 Retail

36 Residential

44 Multi-family

52 Hospitality

58 Institutional

FOR THE TRADE

64 Trade Program

66 Lunch & Learns

68 Trade Shows & PID Floors Design Inspiration Awards

74 Representing The Brand

76 Industry Access

IMAGINE IT

THE CUSTOM FLOORING JOURNEY

PID FLOORS INTERNATIONAL

COLLECTIONS

90 Angles Collection

94 Traditional Collection

98 Modern Collection

102 inLove Collection

108 Liberty Collection

112 Foundation Line

116 Chêne Collection

120 Drift Collection

124 Well-Treated Collection

128 Top Line

132 Board Collection

136 Reclaimed Collection

140 Herringbone/Chevron Collection

144 Finelock Collection

148 Crave Collection

152 RQ VI Collection

156 Parquet Collection

162 Pure Collection

166 Selected Collection

170 Tandem Oak Collection

174 Walnut Collection

178 Unfinished Collection

CONTACT US

Our Story

THE PID FLOORS DIFFERENCE

For over three decades, PID Floors has earned a reputation as a leader in the hardwood flooring industry, offering extraordinary products—unrivalled in variety and accessibility—and exceptional service.

PID Floors was founded in 1989 by a family from the former Soviet Union, who arrived in the United States with only a sanding machine and a shared dream. Undaunted by a new culture and a new language, they believed that with an unwavering dedication to hard work, love, and exquisite craftsmanship—truly anything is possible.

This ethos is the foundation upon which PID Floors was built and which continues to be our philosophy over 30 years and three generations later. PID Floors remains a family-run company that prides itself on treating each of our clients like an old beloved friend: we are family and so are you. This deeply instilled ethic of authentic personal service combined with the promise of a high-quality product creates an exceptional and trusted quality of experience; this has allowed us to continuously satisfy the needs and tastes of our discerning clients and maintain our position as one of the most respected wood flooring companies in the world.



Our Ideals

WE BELIEVE

That people come before business.

In luxury without elitism.

In style without sacrificing sustainability.

In efficiency combined with friendliness.

In a Bespoke Approach: No client or project is ever the same.

Our relentless dedication to knowledge, expertise, innovation, and ease of service from start to finish, all stems from a deep love for what we do and a true desire to make all of our customers' flooring design dreams become a reality.

ENDLESS POSSIBILITIES

Our mantra at PID Floors has always been "Something For Everyone." We give customers effortless access to the best selection of products from around the world. We consider ourselves a meticulously curated one-stop shop—we carry over 700 standard items in our inventory, most of which are stocked locally for quick delivery. For many years we have traveled the globe, in pursuit of finding the best materials and remain passionately committed to continuously seeking out the best as our industry evolves. Complete with full-bespoke capabilities, we believe in truly "having it all," and making it easily accessible for our customers. This is why we have become a trusted and respected institution for architects, designers, developers, and homeowners.

BEYOND A SHOWROOM

PID Floors has elevated our operation and expanded our influence beyond that of a typical flooring showroom:

- We have developed a first-class logistics network with the capability of shipping to and from locations throughout the globe.
- We own and operate our own local warehouses and distribution centers, complete with fully functional storage, packing, and delivery capabilities. Every step is "in-house."
- We are committed to working with our customers, hand in hand and will be there every step of the way, avoiding the intermediary. From start to finish—from selection to delivery—you will be dealing with us and only us and can expect superior white glove service throughout.



INSIGHTFUL AND EDUCATED STAFF

For three decades, we have focused our efforts solely on hardwood flooring which gives us a unique and exceptional level of expertise. Our staff is comprised of highly trained and knowledgeable flooring experts who guide customers through the PID Floors design process. We are passionate about listening to all our customers' unique and varied needs and delight in collaborating with our clients every step of the way.

- LEED Green Associates
- NWFA Certified Sales Advisors
- Trained Interior Design Experts
- National Wood Flooring Association Certified Inspectors
- American Institute of Architects Instructors
- Hardwood Federation Lobbyists
- Environmental Specialists with specific knowledge about LEED compliance

A BELIEF IN THE BEST, BUT NOT IN ELITISM

At PID Floors we are committed to offering our customers the very best, but we do not believe in elitism. We are a family-owned and run business and pride ourselves in treating each client like a beloved friend: we are family and so are you. We invite you to visit our showroom; feel welcome to bring your children or dog. Take your time browsing; you often will be offered an

espresso or glass of wine. We believe in expertise combined with friendliness.

CUSTOM AND BESPOKE CAPABILITIES

Our team will work with you to create and design your flooring dreams, no matter how big or small, simple or intricate. We create our custom wood flooring locally in our state-of-the-art facility in Brooklyn, New York. There is no combination of color, finish, texture, plank pattern or direction, which cannot be achieved. Our skilled local craftsman also build, by hand, custom designed medallions, inlays, and parquet. If you can dream it, we can make it!

A COMMITMENT TO GIVING BACK

We love New York City; this is our home. We believe in being an active part of our community and in using our business to make a positive impact. It is our privilege to be able to make ongoing donations to amazing organizations such as: American Forests (Corporate Partners), Sustainable Harvest International (Corporate Partners), City Harvest, Central Park Conservancy, NY Cares, New York Landmarks Conservancy, American Forests, Chabad Center for Jewish Discovery, Philip Berley Preschool of the Arts, George To The Rescue.

Our History

1989
First sanding machine

1990
Began creating Custom Herringbones

1990
Began creating Medallions

1990
First truck

1991
Opened first warehouse

1997
First prefinished sale

1995
Joined NWFA

1992
First trip to Germany

1998
First trip to Asia

1998
Began working with Lopark

2000
First website launched

2000
Started working with Italian artists

2002
First trip to Domotex

2008
First displayed at the Architectural Digest Design Show

2008
Opened Flagship Showroom at 5 W 20th Street in NYC

2015
Steven Skutelsky visits the Senate and House of Representatives in Washington D.C. representing The Hardwood Federation for the first time

2012
InLove Collection was introduced

2012
Opened in D&D Building

2011
Became FSC® Certified

2013
Launched the Home Depot Collection

2016
Opened in Boston, MA

2017
First PID Floors Design Inspiration Awards

2019
MAS Certified Green

2019
PID Floors Celebrates 30th Anniversary

2019
NJ Distribution Center Opens

2019
Expanded our D&D Building Showroom

2022
New showroom in Boston's SoWa Art + Design District opens

2020
Introduced IMAGINE IT! our innovative online tool that allows you to visualize PID Floors in your space with ease using your phone or computer

2020
First Collaboration Collection with Caleb Anderson Launches

2020
PID goes virtual and offers online classes and consultations

2021
Shou Sugi Ban Collection was introduced

2021
PID Miami Opens

Our Commitment

TO THE ENVIRONMENT AND TO YOU

Our planet is a sacred place, and we all have a part to play in preserving its integrity for future generations to have the ability to enjoy its bountiful gifts. As a company that's seen as a leader and trendsetter, we feel an even deeper, innate drive to fulfill our potential by providing access to products which pose the smallest detrimental impact to this place we all call our home.

How do we endeavor to accomplish this?

REFLECTION & RESEARCH

By understanding the potential consequences of our actions, we can look at ourselves candidly and determine where improvements can be made. We focus on educating ourselves and using this knowledge to engineer both short-term and long-term strategies aimed at providing our clients with the opportunity to make a small difference.

TRANSPARENCY & COLLABORATION

Even the smallest idea on the smallest scale can blossom into a truly revolutionary paradigm shift. PID Floors continues to work very closely with the experts at the NWFA, the USGBC, and especially the mills and factories. By being open and honest, and driven by the collective desire to do good, we're able to continuously stay ahead of the curve and display products which have the lowest impact on both the environment and on human health.

DEVOTION & DILIGENCE

Our aim is to have PID Floors products meet or exceed industry standards, both present and future. To that end, we emphasize a company-wide focus on making sure we only deal with suppliers that provide us with the best opportunity to display products that:

- Are responsibly harvested
- Come from legal sources
- Are produced using only ethical practices
- Contain no harmful chemicals that pose short- or long-term health risks for people
- Are compliant with all local and federal regulations regarding formaldehyde and Total Volatile Organic Compound (TVOC) content and emissions
- Come from recycled materials whenever possible, and can be reused rather than disposed of
- Are tested to meet the highest standards for safety, integrity, and performance
- Come from local sources whenever possible, as well as NOFMA-certified mills

PARTICIPATION

We are proud to be members or contributors to influential trade organizations:

AMERICAN INSTITUTE OF ARCHITECTS

PID Floors is a proud provider of the American Institute of Architects (AIA) Continuing Education Units.

AMERICAN SOCIETY OF INTERIOR DESIGNERS

We partner with ASID and its members by sharing our knowledge of wood flooring and our selection of products.

FOREST STEWARDSHIP COUNCIL®

PID Floors has Forest Stewardship Council® Chain-of-Custody (FSC-C132261) license from SCS Global Services. Ask about our FSC® Certified material.

MAS CERTIFIED GREEN®

We care about having MAS Certified Green products at PID because we care about the health of our employees and customers. The MAS Certified Green® Program has rigorous product testing requirements to reduce the release of hazardous chemicals. We are committed to diminish the overall impact of Volatile Organic Compounds (VOCs) and with the emission testing completed by our friends at MAS Certified Green, we can certainly achieve our commitment.

U.S. GREEN BUILDING COUNCIL

The USGBC takes creating healthy, highly efficient, and cost-saving green buildings very seriously, and so do we. AS USGBC



members, we are provided with exclusive credentialing opportunities. Many staff members at PID Floors have completed training through the USGBC and have become Leadership in Energy and Environmental Design (LEED) Green Associates.

HARDWOOD FEDERATION

PID Floors works closely with the Hardwood Federation, widely known as "The United Voice of the Hardwood Industry." Our Managing Partner annually travels to Washington, D.C. to speak to the United States Congress about important issues related to the industry.

NATIONAL WOOD FLOORING ASSOCIATION

The National Wood Flooring Association (NWFA) is a non-profit trade organization of the hardwood flooring industry. The NWFA is a pivotal marker of advancements in the industry as it helps to connect professionals from across the country and acts as a driver in setting industry standards. This organization has helped us create a strong business network and establish a robust technical understanding of our profession. The NWFA has had and continues to have a positive influence on our company, and we whole-heartedly support the association.

STANDARDS AND CERTIFICATIONS



PID Floors aims to reduce impacts on human health by eliminating harmful levels of chemicals in our products through the reassurance of meeting standard requirements set by strict indoor air quality certifications. We also have a responsibility to the environment to source our raw materials from well-managed forests.



CDPH STANDARD METHOD V1.2 (2017) SPEC 01350

California Department of Public Health (CDPH) Standard Method v1.2 (2017) is an expanded standard for California Specification 01350, which is used to evaluate building and interior products for low chemical emissions. The CDPH Standard Method v1.2 (2017) is currently the most popular US standard for evaluating and restricting VOC emissions of indoor products.



FLOORSCORE AND GREENGUARD

FloorScore® is a third-party certification developed by the Resilient Floor Covering Institute and Scientific Certification Systems to meet the strict indoor air quality thresholds set forth by the California Section 01350 program. The certification, tests and certifies flooring products in accordance with the volatile organic compound emissions tested with the criteria set forth in the CDPH Standard Method V1.2 (2017). The purpose of the GREENGUARD certification is to promote global sustainability, environmental health, and safety. GREENGUARD sets strict emissions standards based on established VOC chemical exposure criteria.



HEALTH PRODUCT DECLARATIONS

Health Product Declaration® (HPD) Collaborative is a not-for-profit, member association representing the full spectrum of the building industry: architects, designers, building owners, manufacturers, consultants, tool developers, standards programs and others who all share a common purpose to improve the

transparency of information and the material health of the built environment. The HPD Open Standard is a standard specification – composed of a format and instructions for the accurate, reliable, and consistent reporting of product contents and associated health information for products used in the built environment. www.hpd-collaborative.org

FSC® CERTIFICATION

Using wood from responsibly managed forests and tracked by a chain of custody certification is one of the reasons forests in North America are more abundant today than a century ago.

EPA TSCA TITLE VI

The Toxic Substance Control Act has taken the place of the CARB Phase 2 standard for formaldehyde in composite wood products, now enforced as a federal statute in the interest of public health long term.

ENVIRONMENTAL PRODUCT DECLARATION

An Environmental Product Declaration (EPD) is an independently verified and registered document that communicates transparent and comparable information about the life-cycle environmental impact of product. The interest for environmental declarations in building rating systems and certification schemes has increased in the last few years. This may be due to recognition of EPD benefits such as the life cycle approach, the transparent disclosure of relevant impact categories, and the independent verification.

CRADLE TO CRADLE

The Cradle to Cradle Products Innovation Institute administers this life cycle analysis certification to manufacturers and designers to rethink how products are made and what materials the products are made from.



GREEN BUILDING CERTIFICATIONS

LEED

LEED in Energy and Environmental Design, is a green certification program for building design, construction, operations and maintenance. Developed by the U.S. Green Building Council (USGBC), LEED provides a framework to create healthy, highly efficient and cost-saving green buildings, and is the most widely used green building system in the world. LEED regularly undergoes evaluations, whether through clarification of specific credit's language, an adaptation to an existing rating system, or a comprehensive update to its rating systems. The newest version is called LEED v4.1 and it is the most inclusive and transparent platform to date.

THE WELL BUILDING STANDARD™

The WELL Building Standard™ is the leading tool for advancing health and well-being in buildings and communities globally. WELL Certified™ spaces harness the built environment as a vehicle to support human health, well-being, and comfort.

PASSIVE HOUSE

Passive House is a building standard that is truly energy efficient, comfortable and affordable at the same time. This standard is used to design Net-Zero Energy Buildings. One of the requirements of improving efficiency of a building is based off of the airtightness of a building. This standard calls for the airtightness to be a maximum of 0.6 air changes per hour at 50 Pascals pressure (ACH50). Building materials used within tightly built, energy-efficient buildings should not compromise the quality of the indoor air environment and ultimately prevent jeopardizing the health of the building occupants.

LIVING BUILDING CHALLENGE 4.0

The Living Building Challenge (LBC) is a green building certification program and sustainable design framework that visualizes the ideal for the built environment.



PARTNERSHIPS



PARTNERSHIP WITH AMERICAN FORESTS

PID Floors has partnered up with American Forests to plant 5,000 trees across America this year! We invite our friends and partners to donate and work hand in hand with us to combat climate change and to honestly practice sustainable forestry.

A Statement from American Forests:

“American Forests creates healthy and resilient forests, from cities to wilderness, that deliver essential benefits for climate, people, water and wildlife. We advance our mission through forestry innovation, place-based partnerships to plant and restore forests, and movement building.”



PARTNERSHIP WITH SUSTAINABLE HARVEST INTERNATIONAL (SHI)

We will work together to educate farmers in Central America, hinder deforestation, and reverse climate change. PID Floors is passionate about gaining and spreading knowledge, and we could not be more excited to learn and to share sustainable farming techniques.

A Statement from SHI:

“Our proven model equips and empowers low-income farmers with the resources to implement alternatives to slash-and-burn agriculture, sustain the land for future generations of farmers, halt tropical deforestation, and build strong, self-supporting communities through agribusiness.”



Our Portfolio

*Our clients inspire us every day.
We hope to return the favor.*

PID Floors is the destination for those in search of luxury, style, sustainability, and dedicated service. As our client list grows, as well as the number of showrooms open to the public, our reputation for exemplifying the highest standards in product and service speaks for itself, and we are sought out by internationally renowned designers, global brands, and esteemed institutions alike. As we continue to expand, we never lose sight of original values: at our core we are a heart based company.



VIDETTE
SKU: LFO83520
One Vanderbilt Altus Suites / New York, NY

Our Portfolio

COMMERCIAL

Inspired working spaces with floors that support a company's brand and vision. From airports, banks, and law firms, to offices of every kind and size.



convene.

LIDA
SKU: DTAMS6019
Convene | New York, NY



CUPERTINO
SKU: PAC101
90 Columbus | Jersey City, NJ



W
THE WING

CUSTOM
The Wing | San Francisco, CA



wework

CUSTOM ENGINEERED
PREFINISHED WHITE OAK
WeWork | Chicago, IL



VIDETTE
SKU: LFO83520
One Vanderbilt Altus Suites | New York, NY



FOUNDATION LINE
BELIEVE WITH BRASS INSERTS
SKU: MRFo4
157 W 18th Street | New York, NY

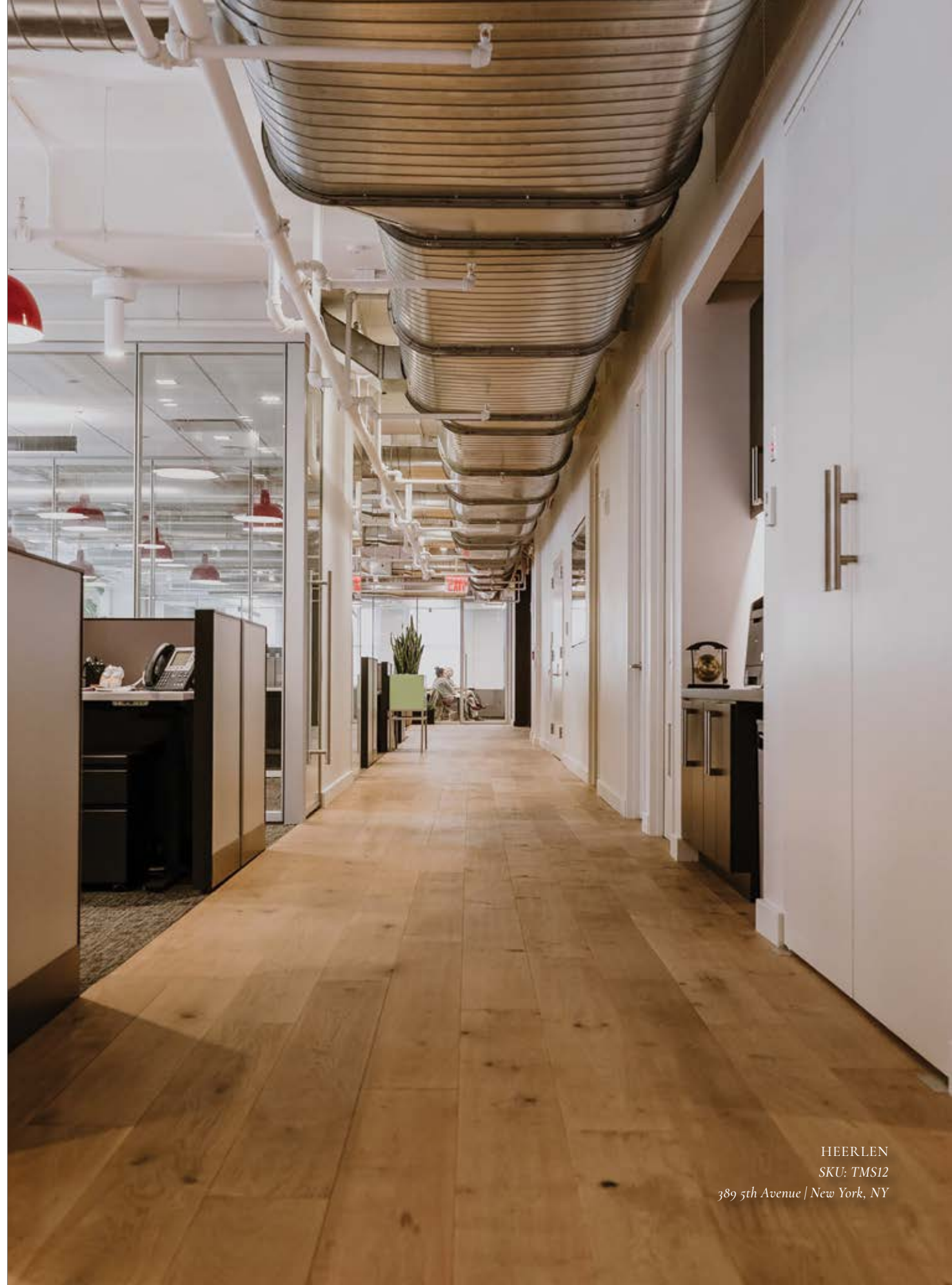

HEERLEN
SKU: TMS12
389 5th Avenue | New York, NY

Our Portfolio

RETAIL

Iconic luxury brands with elegant boutiques and showrooms across the globe.



CUSTOM LIBERTY COLLECTION
Piaget | Bal Harbour, FL



CUSTOM LIBERTY COLLECTION
Tory Burch | New York, NY



CUSTOM LIBERTY COLLECTION
Bottega Veneta | New York, NY



CUSTOM ENGINEERED CHEVRON
Givenchy | New York, NY



CUSTOM
Dior | Short Hills, NJ



INLOVE COLLECTION
CUSTOM FINISHED SOLID OAK FLOORING
Chloé | New York, NY



CUSTOM
Louis Vuitton | New York, NY



CUSTOM
Hermès | Denver, CO



VALENTINO

ARCATA (NATURAL COLOR)
SKU: GN20135
Valentino | Bergdorf Goodman

Our Portfolio

RESIDENTIAL

Because you should love where you live. From Manhattan Penthouses to renovated farmhouses, and everything in-between. These are all the many places we call home.

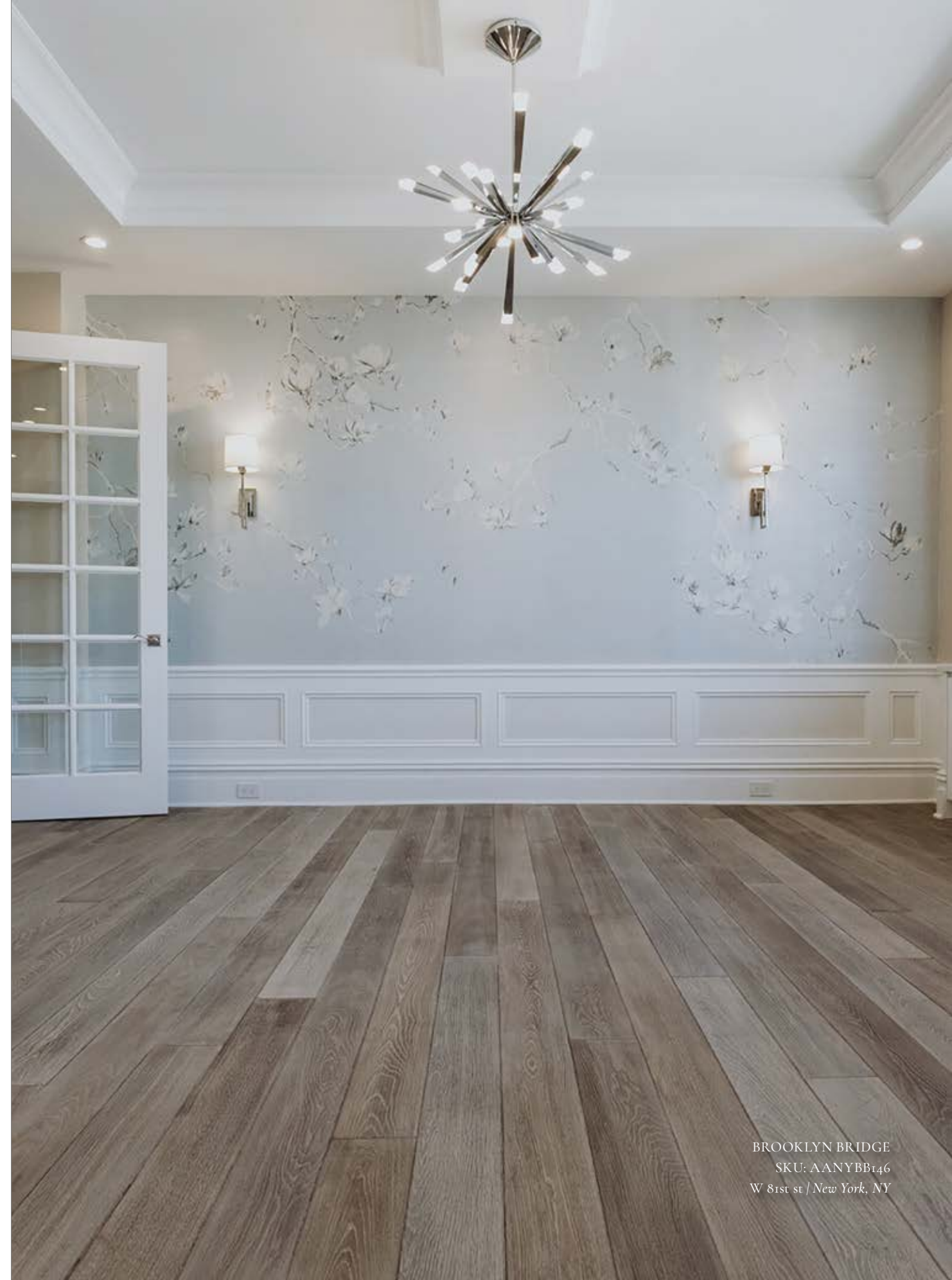

BROOKLYN BRIDGE
SKU: AANYBB146
W 81st st / New York, NY



CUSTOM PHOENIX,
7" WIDE PLAIN SAWN
150 E 69th Street | New York, NY



CUSTOM
211 N 5th St. | Brooklyn, NY



CUSTOM CHEVRON C/H COLLECTION
17th Street | New York, NY



D&D
SKU: AANYDD176
Upper West Side | New York, NY



HILVERSUM
SKU: TMC18
11 Harrison St. | New York, NY



CUSTOM CHEVRON C/H COLLECTION
3 Gramercy Park | New York, NY



CUSTOM
200 E 57th St. | New York, NY



MURRAY HILL
SKU: AANYMH140
104 West 70th St. | New York, NY



COOPER
SKU: QOUW267
14 Horatio St | New York, NY

Our Portfolio

MULTI-FAMILY

An extensive gallery of our larger development projects including condo, conversion, rental, and new construction.

CUSTOM LIBERTY COLLECTION
75 Kenmare | New York, NY
AIA NY State 2021 Design Merit Award



CUSTOM CHÈNE COLLECTION
Riverbank | New York, NY



CUSTOM FOUNDATION LINE
7 West 57th St. | New York, NY



CUSTOM FOUNDATION LINE
CORTE | Long Island City, NY

CUSTOM
1059 3rd Avenue | New York, NY

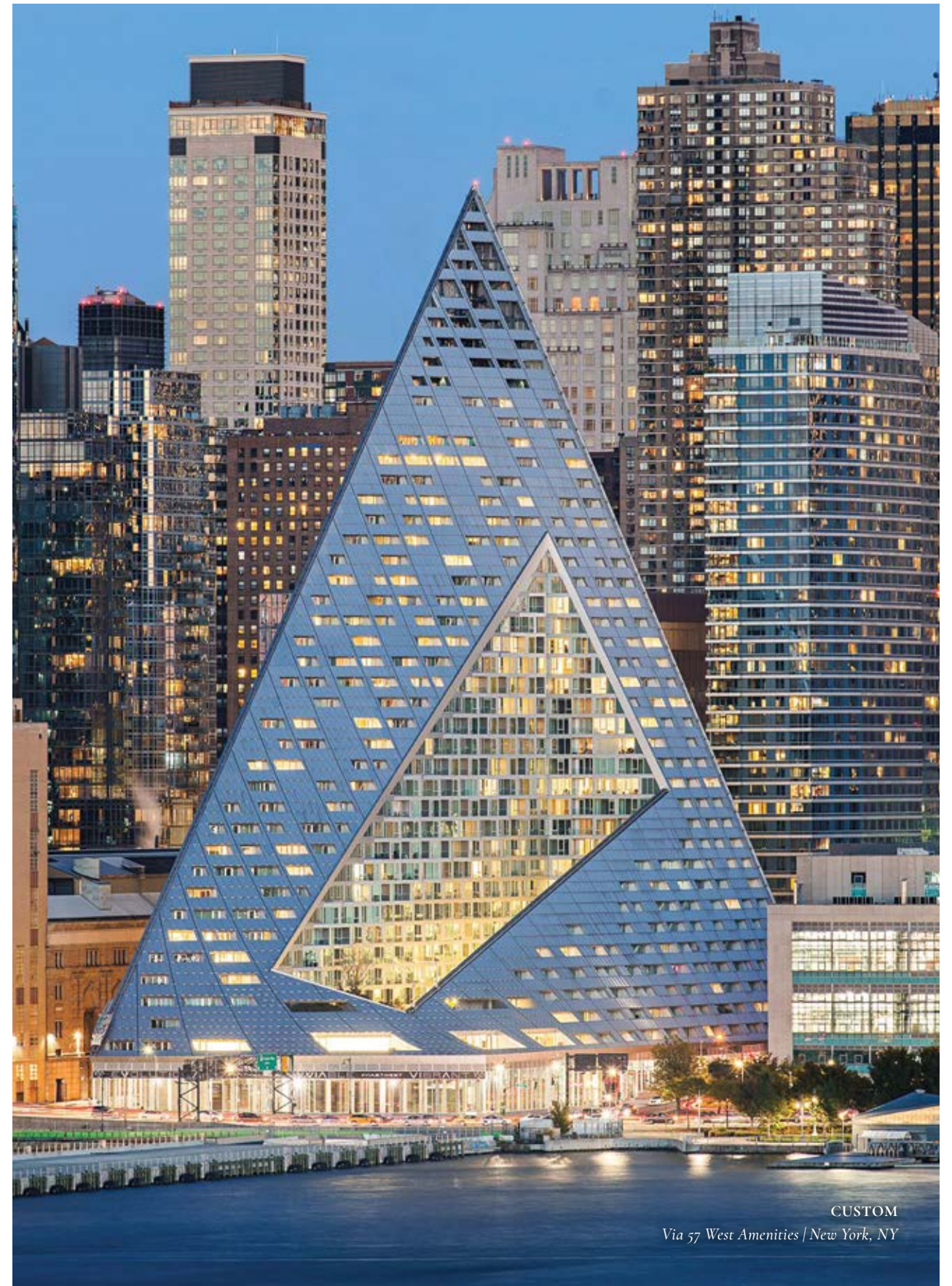

CUSTOM
Via 57 West Amenities | New York, NY

FOUNDATION LINE
CUSTOM COLOR
Vitre | New York, NY



CLAYTON
SKU: RS1016T2-C
The Ritz Plaza | New York, NY



WAVE
SKU: MRF34
Huxley Condominiums | New York, NY

Our Portfolio

HOSPITALITY

Beautifully designed hotels, resorts, spas, and restaurants around the world.



MONTEBELLO
SKU: WG30103L
Nami Nori | New York, NY



CUSTOM
The British Airways First Class Lounges | San Francisco International Airport



CUSTOM
Arlo Midtown | New York, NY



PELICAN
SKU: RS1083TL-C7
Parsley Health | West Hollywood, CA



STUART
SKU: RS1032T1-C
63 Wall Street | New York, NY



TRANBY
SKU: COCT34
Standard Dose | New York, NY



BROCKWAY
SKU: QOUW27
Industrious at Equinox Hudson Yards | New York, NY

Our Portfolio

INSTITUTIONAL

Places of higher learning, including some of world's top universities, museums, and gallery spaces.

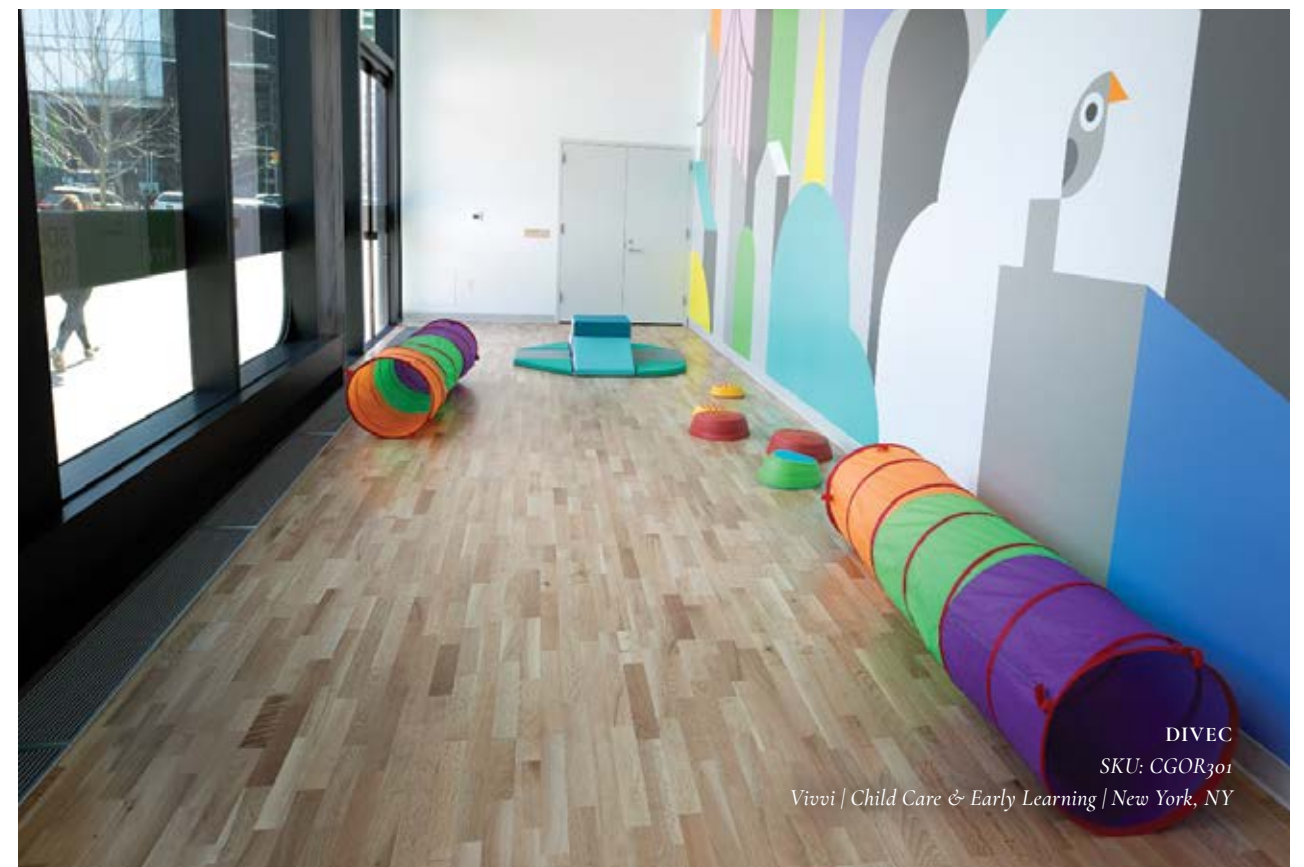



HOPE
SKU: MRFFR1865
Eden Fine Art Gallery | New York, NY



SOLID MAPLE STRIP FLOORING
Hofstra University | Hempstead, NY



BAMBOO FLOORING
Columbia University | New York, NY



LIBERTY COLLECTION SOLID PREFINISHED RED OAK
3/4" CUSTOM COLOR
Princeton University Housing | Princeton, NJ



UNFINISHED COLLECTION
Trinity Church | New York, NY

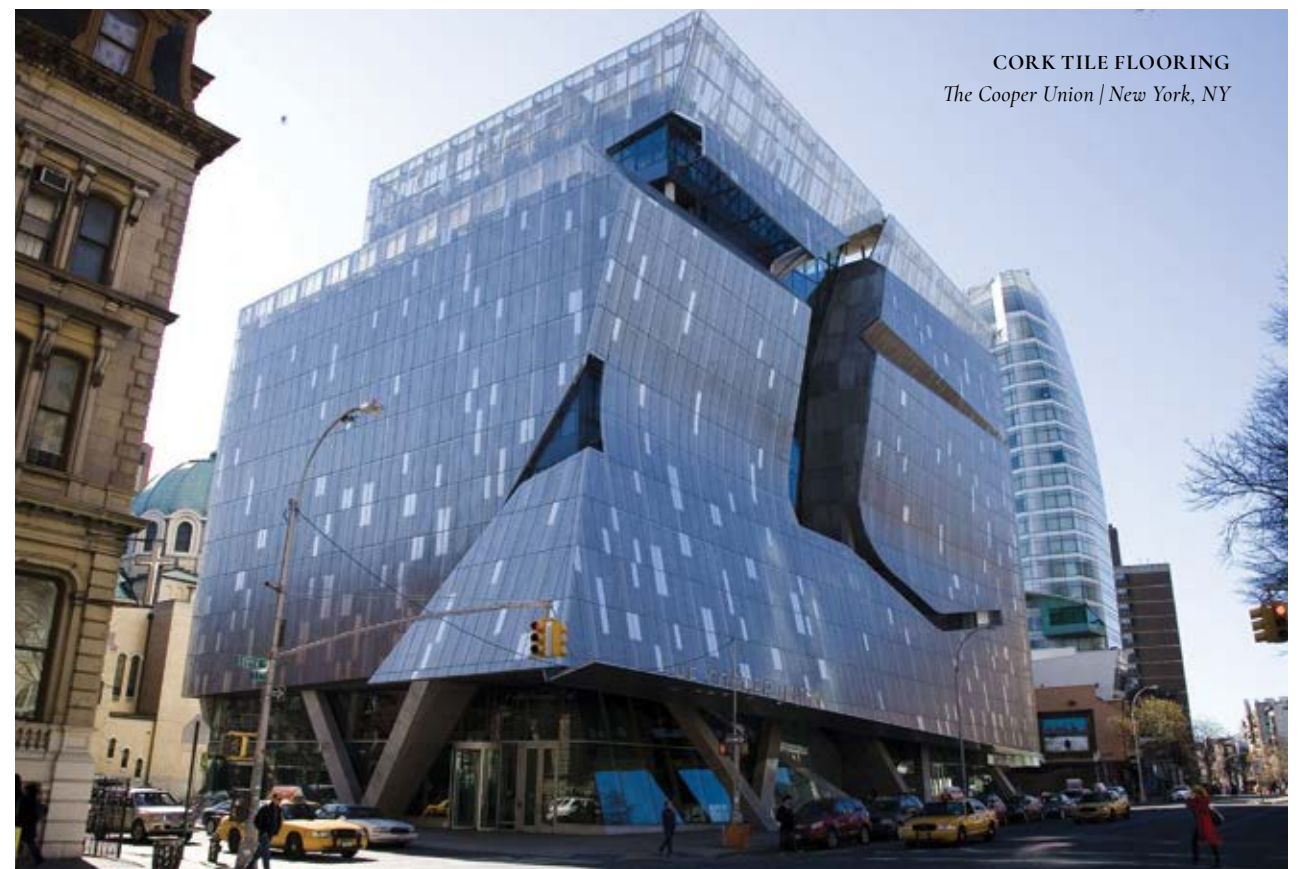

CORK TILE FLOORING
The Cooper Union | New York, NY

For The Trade

THE PID FLOORS TRADE PROGRAM

All professional architects, interior designers, developers, installers, and licensed general contractors are encouraged to join our PID Floors Trade Program.

BENEFITS OF THE TRADE

- Exclusive Discounts & Trade Pricing
- Concierge Services including a personally dedicated Trade Account Executive for one-on-one support
- Extended Showroom hours exclusively for Trade Members
- Invitations to Private Events and Free passes to Trade Shows where we exhibit
- Exclusive preview of new products
- Rights to professional photographs of completed spaces (location restrictions may apply)
- Ability to begin Representing The Brand
- Ability to join our Collaborations Corner and create a unique collection personalized for you
- Industry Updates
- Free Custom Flooring Samples
- Free "Lunch & Learns"
- Automatically entered into our yearly raffle



Scan the QR code using your smartphone to apply for trade program.



LUNCH & LEARNS

For over three decades, we have focused our efforts solely on hardwood flooring which gives us a unique & exceptional level of expertise and we love being able to share that knowledge with you. We are proud to offer AIA, NWEA, USGBC | GBCI Continuing Education courses as well as our own PID Floors courses.

We happily offer both in-person and virtual Lunch & Learns and all of our courses are also available online.

PID COURSES: WOOD FLOORS 101

- This PID Floors Course offers general knowledge of wood floors.
- Through this cumulative course, you will gain knowledge on the basics of wood flooring, wood flooring finishes, and the benefits of wood flooring.
- Upon passing the quiz with an 80% or above, you will be awarded a certificate of completion plaque and also will be recognized on our website!

NWEA ARCHITECT AND DESIGN CONTINUING EDUCATION

PID Floors is proud to offer NWEA (National Wood Flooring Association) Continuing Education Courses. NWEA Continuing Education Courses are registered with organizations that provide continuing education credits to professional architects and designers.

These courses are registered with the following organizations:

- The American Institute of Architects
- The Interior Design Continuing Education Council

- American Society of Interior Designers
- Interior Designers of Canada
- International Interior Design Association

AIA CEU COURSE: GREEN WOOD FLOORS

- Overview of green wood floor options.
- What exactly does it mean for floors to be green?
- Understand the importance of green floors.
- Distinguish the differences between adverse health impacts and impacts on the environment.
- Recognize national and international standards.
- Distinguish the varied benefits of solid and engineered wood flooring covers.
- Identifying the environmental attributes of different flooring options.

AIA CEU COURSE: ENGINEERED VS. SOLID WOOD FLOORS

- Learn the advantages of wood flooring.
- General understanding of the differences between engineered and solid wood floors.
- Understand the benefits and limitations of engineered and solid flooring.



- Gain general knowledge of the installation process for both engineered and solid products.
- Learn the maintenance of both engineered and solid wood flooring.

USGBC | GBCI COURSE: GREEN WOOD FLOORS

- Overview of green wood floor options.
- What exactly does it mean for floors to be green?
- Understand the importance of green floors.
- Distinguish the differences between adverse health impacts and impacts on the environment.
- Recognize national and international standards.
- Distinguish the varied benefits of solid and engineered wood flooring covers.
- Identifying the environmental attributes of different flooring options.

For your convenience upon completion of the course, credits earned will be sent automatically to the CES Records for AIA members. We also provide certificates of completion for non-AIA members, which we are happy to provide upon request. We are always expanding and updating our educational programming.

To schedule an in-person or virtual “Lunch and Learn” for any of these courses contact us at: info@pidfloors.com or 212-337-3433. All of our courses are also available on our website www.pidfloors.com for a nominal fee.



Managing Partner Steven Skutelsky presents Ryan Serhant the 2021 PID Design Inspiration Award.

TRADE SHOWS & PID FLOORS DESIGN INSPIRATION AWARDS

TRADE SHOWS

Every year we enjoy taking the opportunity to highlight our collections or launch new products by exhibiting at various trade shows such as the Architectural Digest Design Show, ICFF, BDNY, Greenbuild International Conference and Expo, and more, both locally and nationwide. We are overwhelmed by the talent of our fellow exhibitors at every show we participate in and filled with design inspiration year after year. We always invite our trade clients to join us and offer tickets for complimentary admission.

PID FLOORS DESIGN INSPIRATION AWARDS

The PID Design Inspiration Award is our annual celebration of our tremendously talented clientele and the beautiful spaces that they have created using PID Floors. We never cease to be inspired by what you—our architect, designer, developer, and homeowner clients—create. Photo submissions are accepted year-round.

Past PID Design Inspiration Award winners have included Ryan Serhant, Eleven of Eleven Architecture for Vivvi Early Learning, Chiara de Rege for the NYC Carolina Herrera Flagship store, and many other incredible PID projects.



BDNY

Boutique Design New York (BDNY) is the leading trade fair and conference for hospitality's boutique and lifestyle design community.



ARCHITECTURAL DIGEST DESIGN SHOW

The Architectural Digest Design Show (ADDS) is the essential showcase for luxury design, all in one place.



ICFF

The International Contemporary Furniture Fair (ICFF) is North America's leading platform for contemporary furnishing design.



THE DESIGN DISTRICT SHOWROOM COCKTAIL CRAWL

The Design District Showroom Cocktail Crawl is organized by The Architect's Newspaper and AN Interior annually.



28TH ANNIVERSARY SOIRÉE

Since 1989 we opened proudly as a family-owned and run business. Over 30 years and three generations later, PID Floors remains a family-run company that prides itself in treating each of our clients like an old beloved friend: we are family and so are you. On the 28th anniversary of PID Floors, we threw a party to celebrate and to say thank you to our family of clients these past 28 years; they mean the world to us.



PID FLOORS VIDEO | 30 YEAR ANNIVERSARY

We are so excited to share with you our 30-year anniversary video! For over three decades, PID Floors has been dedicated to hard work, love, and exquisite craftsmanship, and will continue and grow on this path for decades to come!

Scan QR Code to watch our 30 year anniversary video.



REPRESENTING THE BRAND

Since 1989, PID Floors has earned a reputation as a leader in the hardwood flooring industry and has become a trusted institution for architects, designers, developers, and homeowners. By representing and displaying the PID Floors brand in your office or showroom you will be joining an internationally respected company that offers extraordinary hardwood flooring products—unrivaled in variety and accessibility. To begin exploring a Brand Representation opportunity, please contact: info@pidfloors.com



WALL DISPLAY



8 SLOT DISPLAY



INLOVE BINDER

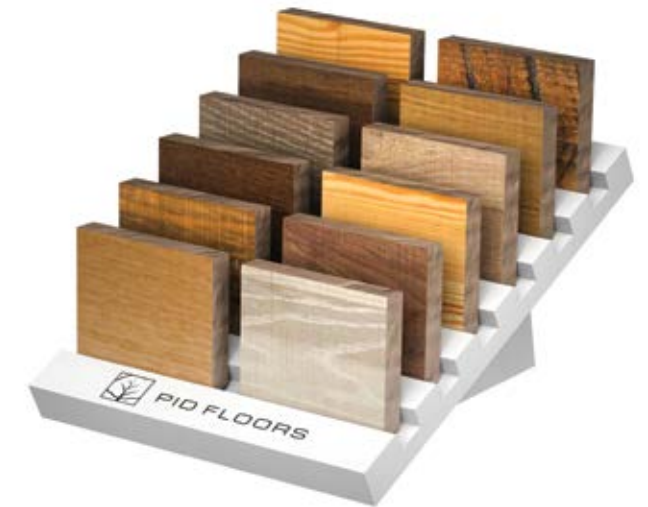

TABLE TOP DISPLAY



Managing Partner, Steven Skutelsky,
on Capitol Hill in Washington, D.C.

INDUSTRY ACCESS

PID Floors is dedicated to remaining on the forefront of the important issues affecting our industry, our communities, and you. We endeavor to protect, to promote, and to educate in order to make a positive impact within our industry. We are proud to work closely with:



THE HARDWOOD FEDERATION

Since 2015, our Managing Partner Steven Skutelsky has been representing New York State as a lobbyist on behalf of The Hardwood Federation. This includes a yearly trip to Washington, D.C. where Steven meets with U.S. Senators and House Representatives to discuss important legislative matters in the public policy arena impacting the Hardwood Industry.

PID Floors helps support the Hardwood Federation's mission to:

- Promote and represent the common business interests and improve business conditions among members of the hardwood industry
- Maintain a healthy business environment for family businesses and small companies in the hardwood community
- Maintain commercial access to federal and private hardwood timberlands
- Maintain and improve the health of public and private hardwood forests



NATIONAL WOOD FLOORING ASSOCIATION

The NWFA is an internationally recognized and respected touchstone for everything regarding wood flooring. We are proud to be both a trusted information resource for the NWFA as well as an active participant. Our Managing Partner, Steven Skutelsky, is a member of the NWFA Architect & Designer Committee, and is also a Certified National Wood Flooring Inspector and NWFA Certified Sales Advisor.

US GREEN BUILDING COUNCIL MEMBERS

The USGBC takes creating healthy, highly efficient and cost-saving green buildings very seriously, and so do we. As USGBC members, we are provided with exclusive credentialing opportunities. Many staff members at PID have completed trainings through the USGBC and have become Leadership in Energy and Environmental Design (LEED) Green Associates.



Introducing Imagine It...

This simple and innovative online tool allows you to see PID Floors in YOUR space. Visualizing what types, styles, and colors of hardwood floors would realistically look like in your space could not be any easier.

IMAGINE IT
YOUR SPACE. OUR FLOORING.

STEP 1:

- Take a live photo from your cellphone directly or
- Use a photo from your existing photo library or
- Choose a photo saved on your computer

STEP 2:

- Pick and choose any hardwood floors
- Share your choices with others
- Download the images you love



To use the Imagine IT tool, scan the QR code using your smartphone.

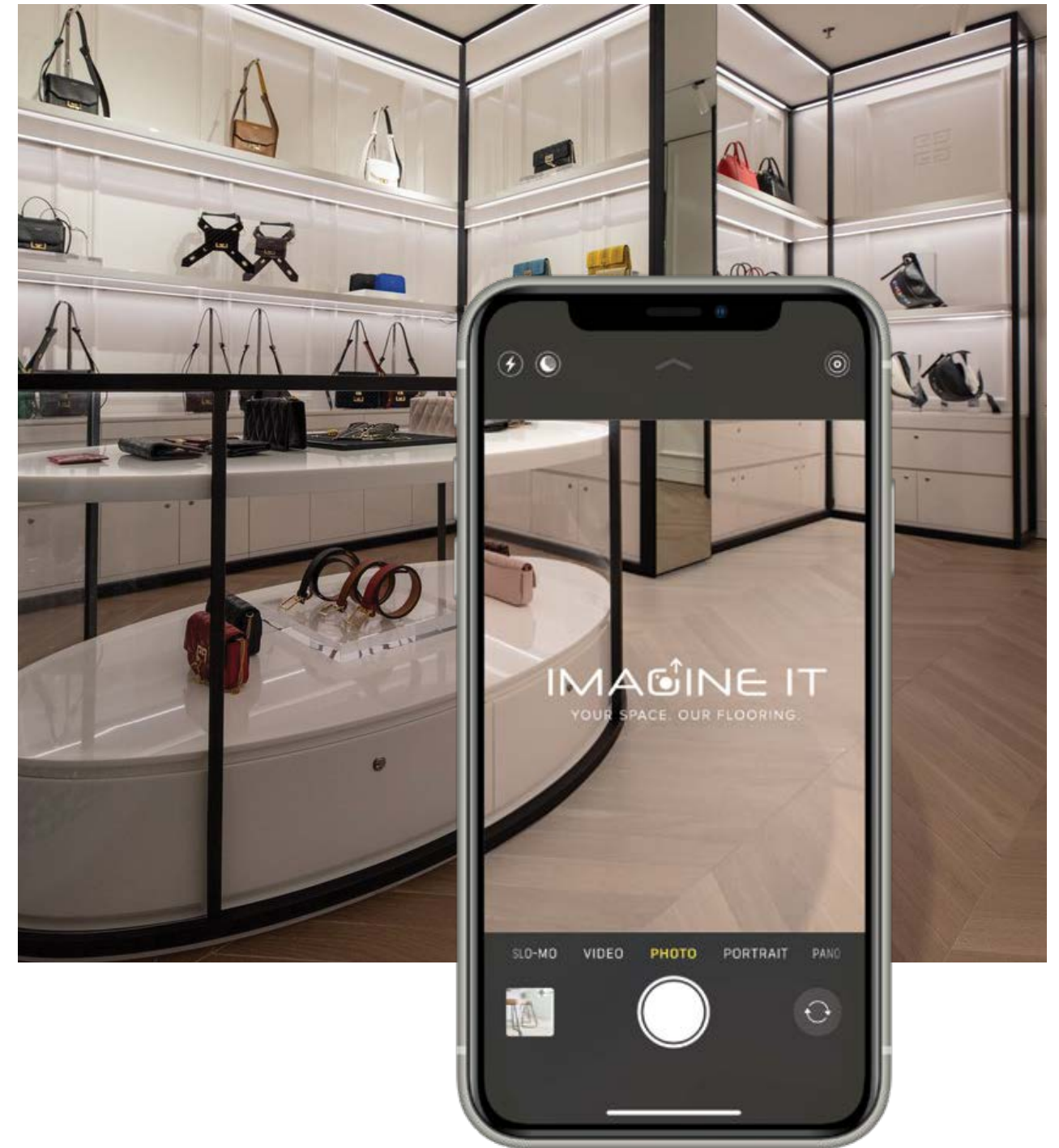

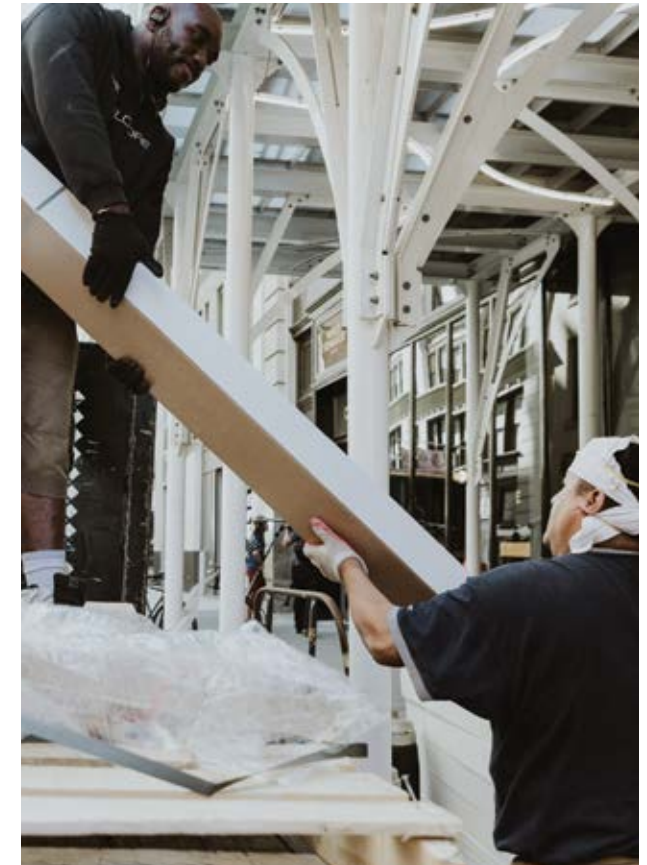

PHASE 1: ANCHORING THE DREAM

- Consultation – Our clients meet with one of our flooring account representatives to define their new floor. Covering everything from aesthetics & performance, to budget and lead time.
- Color & Structured Details – Our staff will share their vast knowledge about the many benefits for each type of solid or engineered flooring to best meet your specific need.

PHASE 2: CREATING THE PLAN

- Dimensions & Characteristics – Next, it's time to dive into the details of what will make this floor perfect for you. We discover together what type of species, grade, finish, cut, pattern, and so much more will make this floor truly yours.
- Sustainability – With several LEED Green Associates on staff, we are very conscious of meeting the highest of health and environmental standards. We make sure our priorities are in line with yours and determine the best ways to ensure your custom floor is sustainable for many years to come.

PHASE 3: BUILDING THE FOUNDATION

- Sample Creation – Now it's time to get to work! Our team creates a sample to illustrate exactly what your floor will look and feel like to ensure it is what you had in mind.
- Approval – The sample is now placed in your hands to touch, feel, and see the quality and texture of the floor we are custom creating for you.
- Custom Production – After approval, the team jumps into full production mode to create your flooring

PHASE 4: RECEIVING AND ENJOYING YOUR CREATION

- Logistics: Getting the flooring to the customer via land, sea, or air – No matter where the location, we will deliver your flooring right to your curb for your contractor to take it from there.
- The beautiful floor is installed in the space – Voilà! It's time to enjoy your custom created floor in your beautiful space.
- Lastly, we show you the tools necessary for maintenance so you will have a high-quality floor for many years to come.



D&D
SKU: AANYDD176
Upper West Side Residence | New York, NY



MULBERRY STREET
SKU: AANYMS35
254 Park Ave. | New York, NY



INLOVE COLLECTION CUSTOM
781 Fifth Avenue | New York, NY



CUSTOM
17th Street | New York, NY
Winner of our 2017 Design Inspiration Award

PID Floors International

We have developed a first-class logistics network with the capability of shipping around the globe.

It is our pleasure to deliver our hardwood floors, whether it is by land, by air, or by sea, to our many international customers. PID Floors can be found worldwide. We own and operate our own warehouses and distribution centers, complete with fully functional storage, packing, and delivery capabilities. We will take care of every detail from door to door. Please let us know how we can assist you with your hardwood flooring needs abroad.

PID Floors can be found in Commercial, Retail, Residential, Multi-Family, Hospitality, and Institutional Projects all throughout the world including: Canada, Central America, Europe, Asia, the Middle East, and Australia.

INTERNATIONAL PROJECTS:

Tory Burch Retail Locations:

Shop 106, K11 Musea Docksider
18 Salisbury Road, Tsim Sha Tsui, Kowloon | Hong Kong
IFC | Hong Kong
Element | Hong Kong
Qingdao Hisense | Hong Kong
Shop L102A, Spring City 66
No. 21-23 Dongfeng East Road, Panlong District, Kunming | China
Xian SKP | China
Wuxi Yaohan | China
Taj Mall | China
Galaxy Macau | China

SAFS 2822, Shoppes at Four Seasons Estrada da Baía de N. Senhora da Esperan

Cotai Strip®, Taipa, Macao SAR, P.R. | China

Greenbelt 5 | Philippines

Manila | Philippines

Ginza | Japan

Gurney Paragon | Singapore

The Gardens | Singapore

Senyan City, Jakarta | Indonesia

Bangkok | Thailand

LCC | Malaysia

KLIA 1, Satellite | Malaysia

New Delhi Emporio | India

Al Khayyat Commercial Center

Ar Rawdah, Jeddah 23435 | Saudi Arabia

KLCC | Malaysia

Vendome

Kingdom Center | Riyadh Saudi Arabia

Al Khayyat Commercial Center | Jeddah Saudi Arabia

Winnipeg Kunminf Spring City 66

John Bull | Bay Street, Bahamas

Regent Street | London

Westfield | London

San Juan Puerto Rico

Chile

Baku

Panama

Mexico City

Baha Mar

Westfield Bondi | Australia

Cambodia

Dior Retail Locations:

Macau Venetian | China

Shanghai Homme IFC | China

City of Dreams Macau | China

Ginza Tokyo Homme | Japan

PAP Homme Lafayette | Germany

Le Printemps Haussmann | Paris

Melbourne, Australia

Saks | Toronto

PAP Homme Lafayette | Germany

Tiffany & Co. Retail Locations:

Urawa Isetan | Japan

Kokura Izutsuya | Japan

Kingpower Rangnam | Thailand

Iyotetsu Takashimaya | Japan

Iconsiamb | Bangkok

Harbin Charter | China

Abu Dhabi Galleria | Abu Dhabi

Pitt Street | Australia

Kingpower Rangnam | Thailand

Dubai

Iyotetsu Takashimaya | Japan

Shinrin Hotel | Japan

Vacheron Constanin | Canada

Magnolia Bakery, Mall of Qatar | Al

Rayyan, Qatar

Laura Mercier - Puerto Rico

Richmont/Vacheron - Vancouver

Away Travel - Yorkdale, Ontario



Collections

METICULOUSLY CURATED BY US.

A ONE-STOP SHOP FOR YOU.

We take great pride in giving effortless access to the best selection of products from around the world. A meticulously curated one-stop shop—we carry over 700 standard items in our inventory, most of which are stocked locally for quick delivery. Complete with full-bespoke capabilities, we believe in truly “having it all.”

COLLECTION
Traditional

M-O-D-E-R-N
Collection

inLove
COLLECTION

LIBERTY
COLLECTION

FOUNDATION
Line
Large-Scale Projects With Ease

CHÊNE
— Collection —

drift
COLLECTION

Well-Treated
COLLECTION

T•O•P
LINE

board
COLLECTION

COLLECTION
Reclaimed

</H
COLLECTION

FINELOCK
COLLECTION

Crave
COLLECTION

ROVI
COLLECTION

Parquet
COLLECTION

Pure
COLLECTION

Selected
Collection

TANDEM
OAK
COLLECTION

COLLECTION
WALNUT

angles
collection
A Caleb Anderson Collaboration

UNFINISHED
COLLECTION

angles collection

A Caleb Anderson Collaboration

A CALEB ANDERSON COLLABORATION

This unique and modern collection is American-made with 45° Chevron Cut Rift & Quartered White Oak which has been laid down in a straight Plank Style Pattern. This collection emerged from a mistake-turned-experiment. When we had a leftover box of “all lefts” Chevron, we decided to see what would happen if we laid them together in a plank pattern. We absolutely loved the look and feel of this “accidental” floor and hence the Angles Collection was born! The Angles Collection is a new twist on a timeless style in collaboration with one of New York City’s most incredible design talents, Caleb Anderson.



To view the complete Angles Collection, scan the QR code using your smartphone.





SACRAMENTO
SKU: ASO500-RQA
White Oak (North American)



DENVER
SKU: ASO600-RQA
White Oak (North American)



LITTLE ROCK
SKU: ASO400-RQA
White Oak (North American)

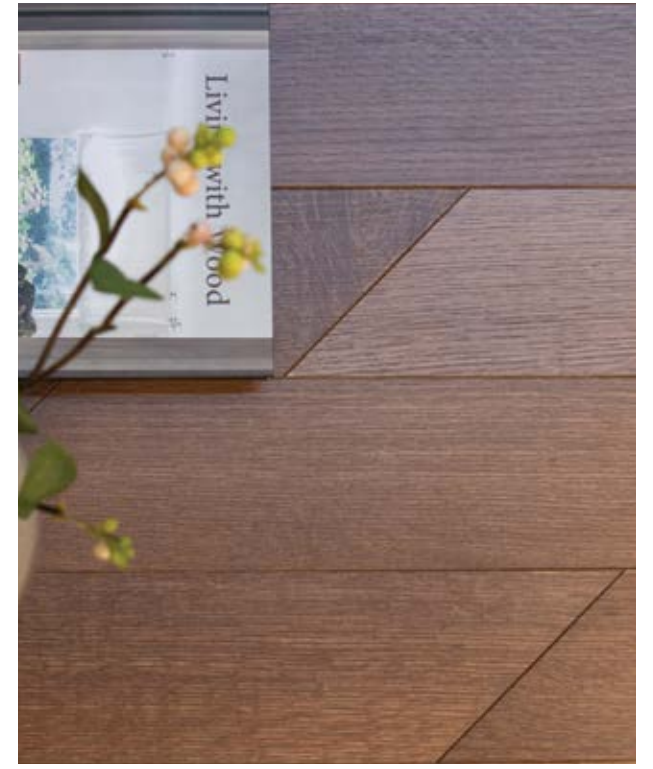

HARTFORD
SKU: ASO700-RQA
White Oak (North American)



TALLAHASSEE (NATURAL COLOR)
SKU: ASO800-RQA
White Oak (North American)



PHOENIX
SKU: ASO300-RQA
White Oak (North American)



JUNEAU
SKU: ASO200-RQA
White Oak (North American)



MONTGOMERY
SKU: ASO100-RQA
White Oak (North American)

COLLECTION
Traditional

REFINED ELEGANCE. CLASSIC STYLE.

Our Traditional Collection is focused on creating a timeless look by embracing a classic style. Filled with a vast assortment of beautiful colors and finishes, this collection is perfect for any space where a look of refinement, sophistication, and an enduring appeal is desired.



To view the complete Traditional Collection, scan the QR code using your smartphone.





STETSON
SKU: QOUL64
White Oak (European)



VANCEBORO
SKU: QOUV63
White Oak (European)



ORIENT
SKU: QOUB62
White Oak (European)



MEDWAY
SKU: QOUS61
White Oak (European)



PRAESTO
SKU: PLHC93
White Oak (European)



NIVA
SKU: PLHC92
White Oak (European)



FREJLEV
SKU: PLNC91
White Oak (European)



NORDBY
SKU: PLCR90
White Oak (European)



WILTON
SKU: QOUC59
White Oak (European)



HARTLAND
SKU: QOUL57
White Oak (European)



TRIGE (NATURAL)
SKU: PLTV102
Ash



AUNING
SKU: PLTC101
Ash



SABRO
SKU: PLCM89
White Oak (European)



KLARUP (NATURAL)
SKU: PLCT88
White Oak (European)



NIBE
SKU: PLCC87
White Oak (European)



MARIBO
SKU: PLCC86
White Oak (European)



RONDE (NATURAL)
SKU: PLTL100
White Oak (European)



NEXO (NATURAL)
SKU: PLTG99
European Maple



HURUP
SKU: PLTP98
White Oak (European)



SINDAL
SKU: PLTB97
White Oak (European)



HASLEV
SKU: PLCC85
White Oak (North American)

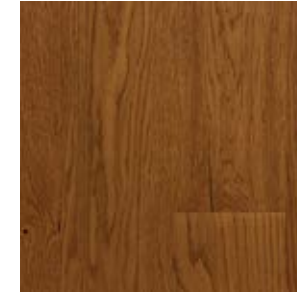

SAEBY
SKU: PLCT84
White Oak (North American)



IKAST
SKU: PLCM83
White Oak (European)

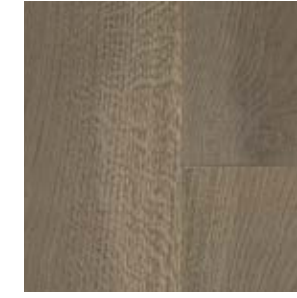

GOSNELLS
SKU: KUCN44
White Oak (European)



BROVST (NATURAL)
SKU: PLTN96
Brovst (Natural)



NYRAD
SKU: PLSP95
White Oak (European)



GUDERUP (NATURAL)
SKU: PLTV103
White Oak (European)



EJBY
SKU: PLHG94
White Oak (European)



MILDURA
SKU: KUCH43
White Oak (European)

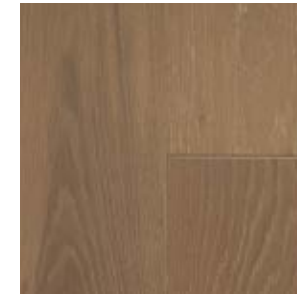

SUBIACO
SKU: KURS42
White Oak (European)



RYDE
SKU: KURD41
White Oak (European)



TARM
SKU: PLCE77
White Oak (European)

MODERN

Collection

CLEAN AND SLEEK. CURRENT AND FRESH.

Our Modern Collection features clean sleek lines paired with a beautiful range of colors. Because the definition of "modern" is ever-evolving, our research team is relentlessly committed to updating our current selection to make sure it always accurately reflects the latest in contemporary trends and color palettes.



To view the complete Modern Collection, scan the QR code using your smartphone.

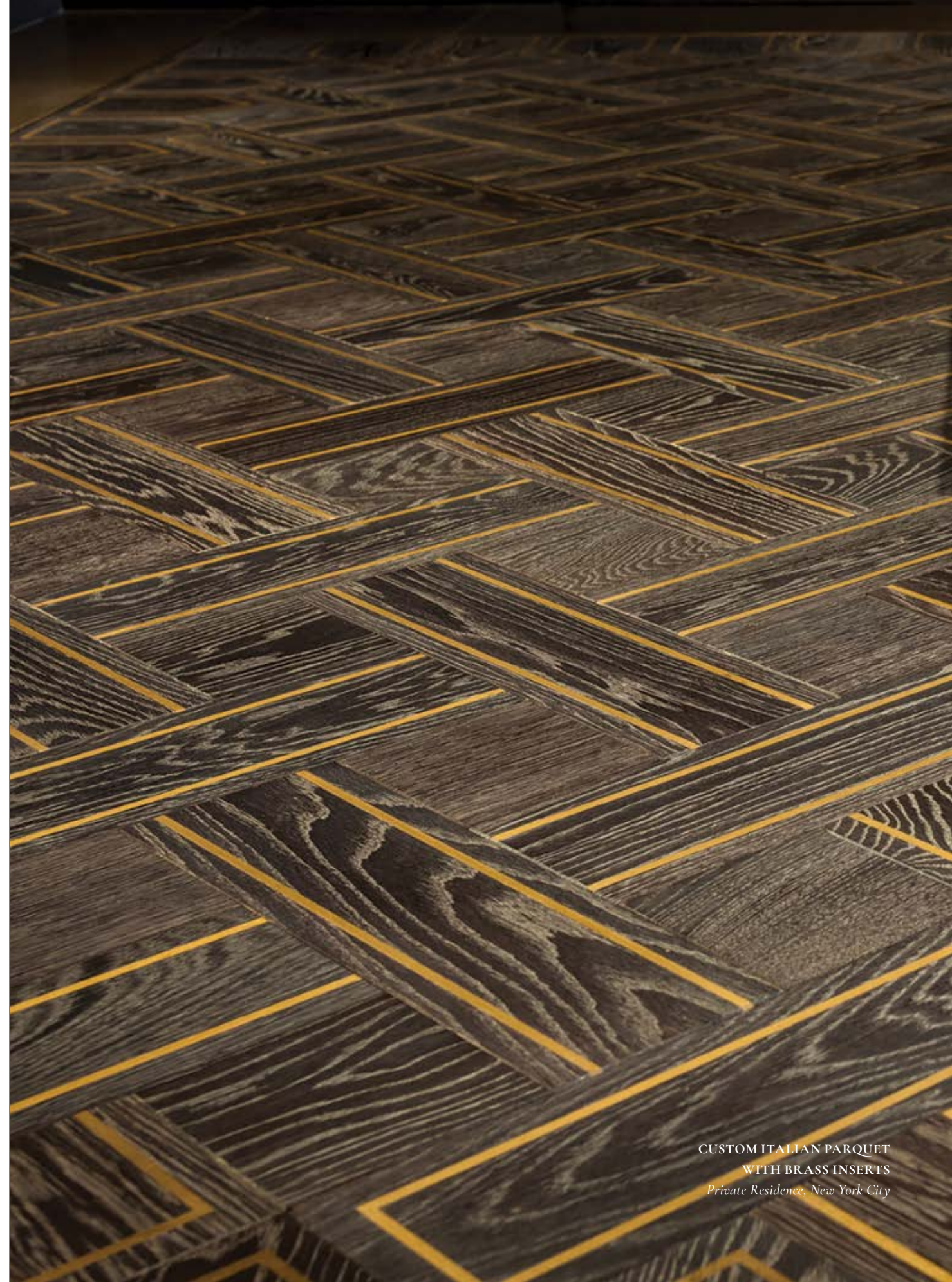

CUSTOM ITALIAN PARQUET
WITH BRASS INSERTS
Private Residence, New York City



BARTLETT
SKU: EWLM95
White Oak (European)



WESEL
SKU: RAH869835
White Oak (European)



TELTOW
SKU: RAH049835
White Oak (European)



PRENZLAU
SKU: RAH980935
White Oak (European)



RIVER EDGE
SKU: ESDS67
White Oak (European)



MAASTRICHT
SKU: TMV16
Ash



NIJMEGEN
SKU: TMC14
White Oak (European)



GRONINGEN
SKU: TMA13
White Oak (European)



TRONDHEIM
SKU: COCP29
White Oak (European)



TRAPANI
SKU: YPAC334
White Oak (European)



CREMONA
SKU: YPAC333
White Oak (European)



LUCCA
SKU: YPAC332
White Oak (European)



SCILLA
SKU: YLT209
White Oak (European)



LIMONE
SKU: YLT207
White Oak (European)



MONDELLO
SKU: YLT202
White Oak (European)



SPELLO
SKU: YLT201
White Oak (European)



FIUMICINO
SKU: YPAC328
White Oak (European)



PERUGIA (NATURAL COLOR)
SKU: YPAC318
White Oak (European)



MODENA (NATURAL COLOR)
SKU: YPAC317
Wenge



LOWELL
SKU: QOUA417
White Oak (European)



LINDAU (NATURAL COLOR)
SKU: RAH476825
White Oak (European)

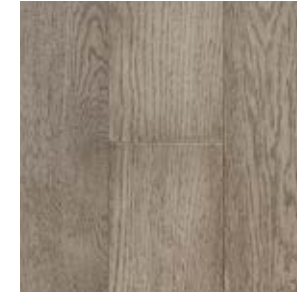

WALHALLA
SKU: BENB09
White Oak (European)



NEWBERRY
SKU: BENM06
White Oak (European)

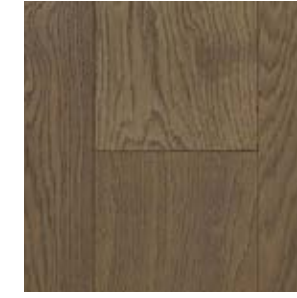

GAFFNEY
SKU: BENM05
White Oak (European)



ZARAGOZA
SKU: SWBC10108
Maple



BAZA
SKU: SWCC11008
White Oak (European)



ALICANTE
SKU: SWTC10708
White Oak (European)



PAMPLOMA
SKU: SWP103
White Oak (European)



BLUFFTON
SKU: BEND02
White Oak (European)



BEAUFORT
SKU: BENC01
White Oak (European)



LANDE (NATURAL COLOR)
SKU: COCN23
White Oak (European)



TRANBY
SKU: COCT34
White Oak (European)

inLove

COLLECTION

BESPOKE BEAUTY. ENDLESS POSSIBILITIES.

Our inLove Collection offers bespoke services that allow us to create custom flooring locally in Brooklyn, New York. If you can dream it, we can create it, and the possibilities are endless. Any and every aspect of our product can be customized—from the species and grade of wood—to the construction and dimensions of the wood planks. This exciting collection embraces both tradition and innovation, employing time-honored woodworking techniques alongside the most cutting-edge in biochemistry. Art and science meet with the use of reactive color processes: wood smoking (also known as fuming) and reaction-based stains.

ZLANTI BALANCED ENGINEERED CONSTRUCTION
3-Layer Croatian European White Oak

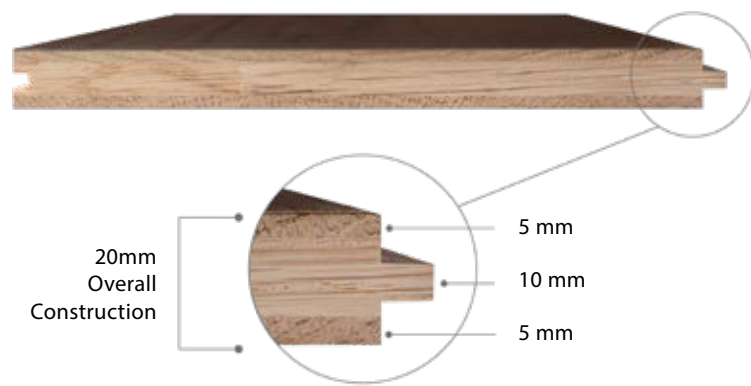

To view the complete inLove Collection, scan the QR code using your smartphone.





MAIDEN LANE
SKU: AANYML190
White Oak (European)



CHRISTOPHER ST
SKU: AANYCS189
White Oak (European)



MANHATTAN AVENUE
SKU: AANYMA187
White Oak (European)



D & D
SKU: AANYDD176
White Oak (European)



PENN STATION
SKU: AANYPS178
White Oak (European)



VANDERBILT AVE
SKU: AANYVA148
White Oak (European)



LAGUARDIA
SKU: AANYLGA134
White Oak (European)



MURRAY HILL
SKU: AANYMH140
White Oak (European)



LITTLE ITALY
SKU: AANYLI98
White Oak (European)



VAN NEST
SKU: AANYVN184
White Oak (European)

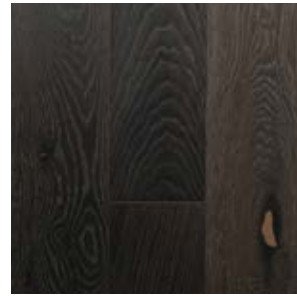

ARTHUR AVE
SKU: AANYAA186
White Oak (European)



FOREST HILLS
SKU: AANYFH82
White Oak (European)



GUGGENHEIM MUSEUM
SKU: AANYGM143
White Oak (European)



FLATBUSH
SKU: AANYFB119
White Oak (European)



COLUMBUS CIRCLE
SKU: AANYCC135
White Oak (European)

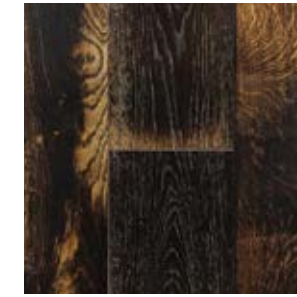

**WASHINGTON SQUARE
PARK- SHUO SOGI BAN**
SKU: AANYWSP132
White Oak (European)



BROOKLYN BRIDGE
SKU: AANYBB146
White Oak (European)



ATLANTIC AVENUE
SKU: AANYAA106
White Oak (European)



MULBERRY STREET
SKU: AANYMS35
White Oak European

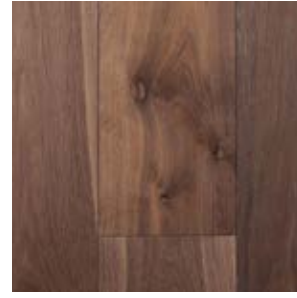

SOUTH STREET FERRY
SKU: AANYSSF128
White Oak (European)



PARSONS BLVD
SKU: AANYPB145
White Oak (European)



HIGH LINE
SKU: AANYHL144
White Oak (European)



FORT GREENE
SKU: AANYFG142
White Oak (European)



BRYANT PARK
SKU: AANYBP130
White Oak (European)



FOREST PARK
SKU: AANYFP177
White Oak European



ATLANTIC BEACH
SKU: AANYAB181
White Oak (European)



HUDSON YARD
SKU: AANYHY180
White Oak (European)



GOLD STREET
SKU: AANYGS179
White Oak (European)



CITY ISLAND
SKU: AANYCI141
White Oak (European)



BROOKLYN HEIGHTS
SKU: AANYBH139
White Oak (European)



FLATIRON DISTRICT
SKU: AANYFD138
White Oak (European)



CHAMBERS STREET
SKU: AANYCS114
White Oak (European)



INLOVE - ZLATNI COLLECTION

Time-honored woodworking techniques alongside the most cutting-edge in biochemistry.

Done by hand, our reaction staining process uses techniques developed over 300 years ago, before the advent of pigment stains or paints. Flooring stains, made from pigment or dye, saturate the wood with color. This saturation of color often masks or conceals the inherent qualities and unique beauty of the wood. Our natural reaction-based stains and wood smoking processes are quite different because they chemically alter the physical structure of the wood, on a molecular level, to produce a desired color or effect. Our custom colors take about eight steps to produce, replicating the true chemical weathering process that wood experiences in nature. We have the ability to produce a wide variety of beautiful effects and colors. Our finishing process is detailed and meticulous. Each board of wood has its finish carefully applied by hand and will then be air dried separately. Our in-house finishing team is constantly developing new and exciting proprietary finishes.

Scan the QR Code to learn more about the inLove Zlatni Process.



Scan the QR Code to watch videos of inLove Zlatni Floors being made by hand.

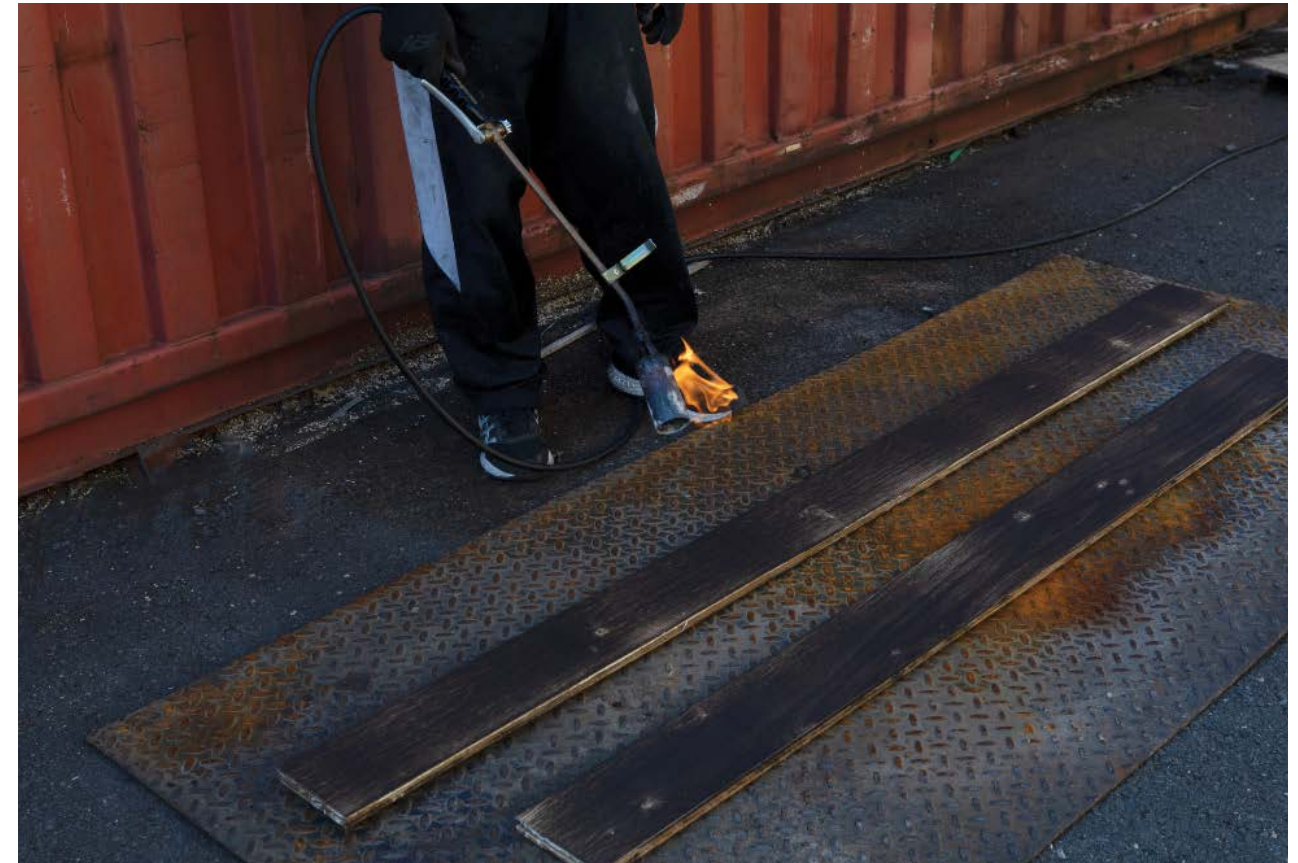

INLOVE | SHOU SUGI BAN

Shou sugi ban (烧杉板), the traditional Japanese technique of staining wood by burning, has arrived at PID Floors!

“Shou sugi ban (烧杉板) is the art of preserving and finishing wood using fire. While shou sugi ban (烧杉板) originated in Japan in the 18th century primarily as way to treat cedar siding to make it weatherproof, the technique—which involves charring a wood surface to render it a deep charcoal-black—has caught on recently as a treatment for contemporary exteriors and indoor furnishings alike... The gravitas imparted by the process and finished result (called yakisugi) are undeniable, a blackening of the wood that reveals clean, distinct lines and an inherent textural beauty.” - From: Clever

Scan the QR Codes to watch videos of the Art of Shou Sugi Ban taking place at the PID Floors Distribution Center in Roselle, New Jersey.

Video 1



Video 2



Video 3



LIBERTY

COLLECTION

AMERICAN OAK. DOMESTIC MANUFACTURING.

The Liberty Collection supports the trend of domestic manufacturing and is sourced, designed, produced, and finished in the United States. Made from North American White Oak which has been grown in responsibly managed forests, this line has been exquisitely milled. This collection is stocked as raw material making it available for your complete customization.

2 LAYERED ENGINEERED CONSTRUCTION

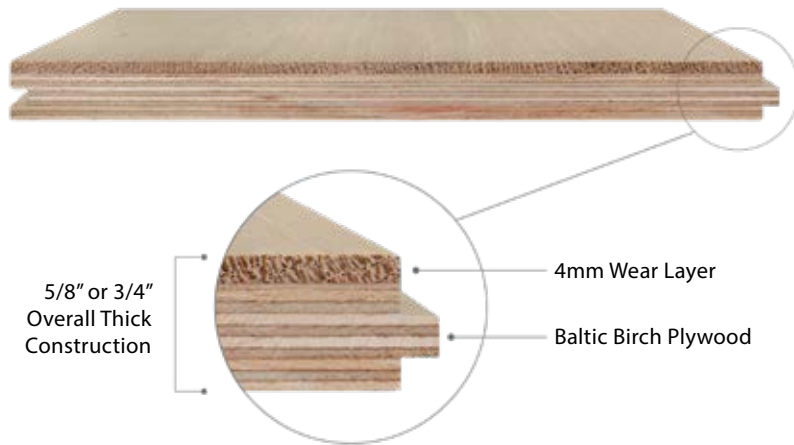

To view the complete Liberty Collection, scan the QR code using your smartphone.



PELICAN
SKU: RS1083Tr-C7
Parsley Health: Los Angeles
8550 Santa Monica Blvd, West Hollywood, CA



BELPRE
SKU: RS1024T4-C
White Oak (European)



BEREA
SKU: RS1017T2-C
White Oak (North American)



BRADENTON
SKU: RS976T2-C
White Oak (North American)



BRUNSWICK
SKU: RS891T3-C
White Oak (North American)



RENDVILLE
SKU: RS889T4-C
White Oak (North American)



ROSSFORD
SKU: RS1026T1-C
White Oak (North American)



SEBRING
SKU: RS993T3-C
White Oak (North American)



SOLON
SKU: RS1027T1-C
White Oak (North American)



CIRCLEVILLE
SKU: RS892T1-C
White Oak (European)



CLAYTON
SKU: RS1016T2-C
White Oak (North American)



COLUMBIANA
SKU: RS1025T1-C
White Oak (North American)



COSHOCTON
SKU: RS890T3-C
White Oak (North American)



STEUBENVILLE
SKU: RS1021T1-C
White Oak (North American)

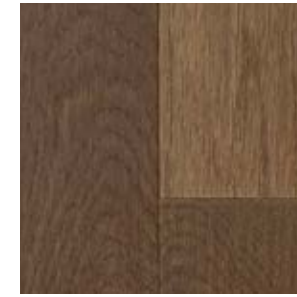

STUART
SKU: RS1032T1-C
White Oak (North American)



WILLOUPHBY
SKU: RS888T1-C
White Oak (North American)



DELAND
SKU: RS1137T4-C
White Oak (North American)



ELYRIA
SKU: RS1252T1-C
White Oak (North American)



FINDLAY (NATURAL COLOR)
SKU: RS1028T1-C
White Oak (North American)



LINEA
SKU: RS1018T1-C
White Oak (North American)



MUNROE FALLS
SKU: RS1019T1-C
White Oak (North American)



FAYETTE (NATURAL COLOR)
SKU: RS9755T1-C
White Oak (North American)

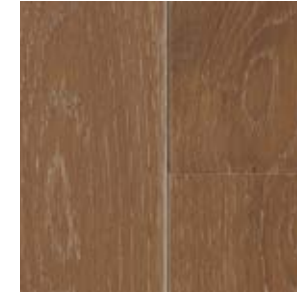

CHARDON
SKU: RS1120T4-C
White Oak (North American)



DEFIANCE
SKU: RS898T4-C
White Oak (North American)



MACEDONIA
SKU: RS980T1-C
White Oak (North American)



OCALA
SKU: RS957T4-C
White Oak (North American)



PELICAN
SKU: RS1083T1-C
White Oak (North American)



PERRYSBURG
SKU: RS1023T2-C
White Oak (North American)



PIQUA
SKU: RS1020T2-C
White Oak (North American)



TUSCARAWAS
SKU: RS929T1-C
White Oak (North American)

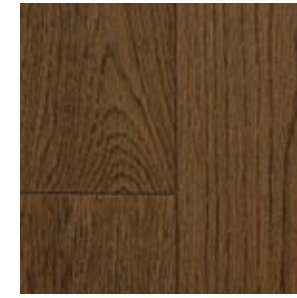

TRUMBULL
SKU: RS1138T2-C
White Oak (North American)



CUYAHOGA
SKU: RS805T1-C
White Oak (North American)



PATASKALA
SKU: RS981T2-CC
White Oak (North American)

FOUNDATION Line

Large-Scale Projects With Ease

LARGE-SCALE PROJECTS WITH EASE.

FULLY CUSTOMIZABLE.

The Foundation Line makes the process of choosing hardwood floors for large-scale projects as effortless as possible. Order sizes begin at a full container - 15,000 Square Feet and up. Made in Europe, this collection has a Two-Layer Engineered construction with a European White Oak top and a Baltic Birch Hardwood Plywood core and can be customized according to the desired width, thickness, and lengths, along with the texture, grade, and sheen. A wide range of stunning colors and finishes, both oil and varnish, are available for selection, along with the option for customization.

2 LAYERED ENGINEERED CONSTRUCTION

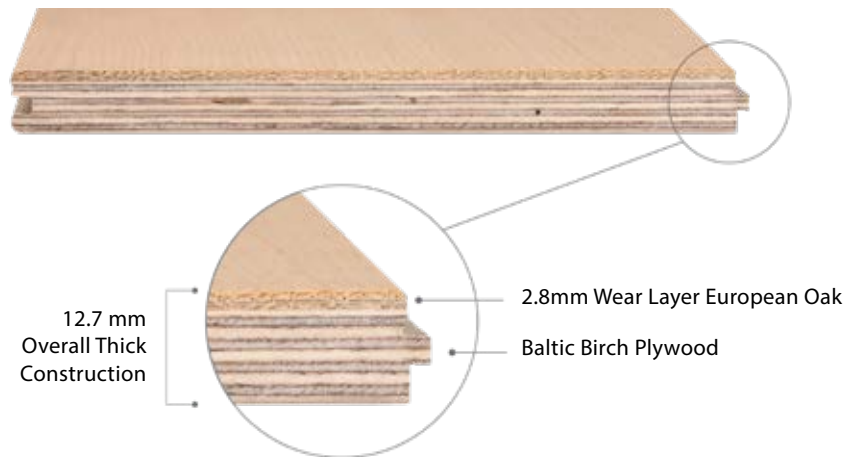

To view the complete Foundation Line, scan the QR code using your smartphone.





HOPE-RAVNO COLLECTION
SKU: MRFFR1865RQ
White Oak (European)



HOPE
SKU: MRFFR1865
White Oak (European)



WAVE
SKU: MRFFR984
White Oak (European)

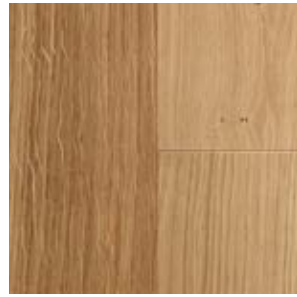

GLORY
SKU: MRFFR71215
White Oak (European)



SLATE
SKU: MRF26
White Oak (European)



SENSATION
SKU: MRF25
White Oak (European)



SAND
SKU: MRF24
White Oak (European)



PROMISE
SKU: MRF23
White Oak (European)



GRACE
SKU: MRFFR31533
White Oak (European)



DESIGN
SKU: MRFFR2102
White Oak (European)



TREASURE
SKU: MRFFR2101
White Oak (European)



INSPIRE
SKU: MRF18
White Oak (European)



PEARL
SKU: MRF22
White Oak (European)

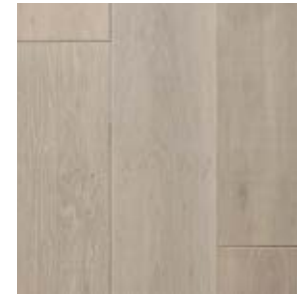

PEACE
SKU: MRF21
White Oak (European)



OLD
SKU: MRF20
White Oak (European)



MIRACLE
SKU: MRF19
White Oak (European)



WONDER
SKU: MRF36
White Oak (European)



WHISPER
SKU: MRF35
White Oak (European)



VINTAGE
SKU: MRF33
White Oak (European)



URBAN
SKU: MRF32
White Oak (European)



IMPRESS
SKU: MRF17
White Oak (European)



GRAFFITI
SKU: MRF15
White Oak (European)

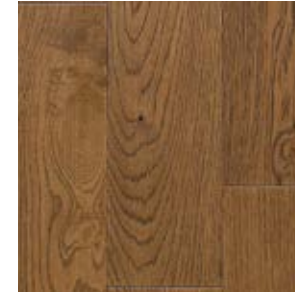

FLAME
SKU: MRF11
White Oak (European)



FEELING
SKU: MRF10
White Oak (European)



TIDE
SKU: MRF30
White Oak (European)



SUNSET
SKU: MRF29
White Oak (European)



STONE
SKU: MRF28
White Oak (European)



SOPHISTICATION
SKU: MRF27
White Oak (European)



DEVOTION
SKU: MRF09
White Oak (European)

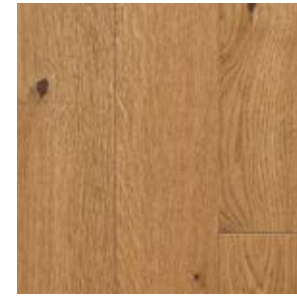

CINNAMON
SKU: MRF07
White Oak (European)

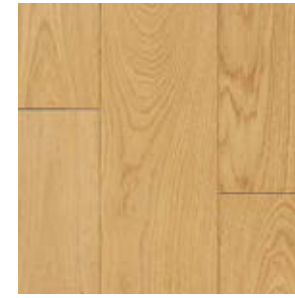

CHARM
SKU: MRF06
White Oak (European)

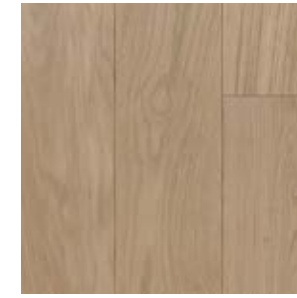

CAPPUCCINO
SKU: MRF05
White Oak (European)

CHÊNE

— Collection —

EMBRACING BOTH TRADITION AND SUSTAINABILITY. ILLUMINATING THE NATURAL DETAILS OF WOOD.

Our Chêne Collection showcases the beautiful natural details of wood by employing the traditional Live Sawn Cut. Originating in Europe, Live Sawn, also known as “European Cut” or “French Cut” is one of the earliest and most historic methods of milling. It is also the most sustainable, due to the fact that it utilizes the entire log with very little waste. In Live Sawn wood milling, the entire log is cut straight through in one slice from top to bottom. The resulting long straight cut planks are extremely durable and also especially beautiful because they illuminate the entire life of each individual tree. Every plank reveals the tree’s unique visual attributes such as cathedral graining—due to the tree’s growth rings, mineral streaks, knots, and many other naturally occurring variations. Every floorboard tells a story about the life of a tree.

3 PLY ENGINEERED CONSTRUCTION White Oak (European)

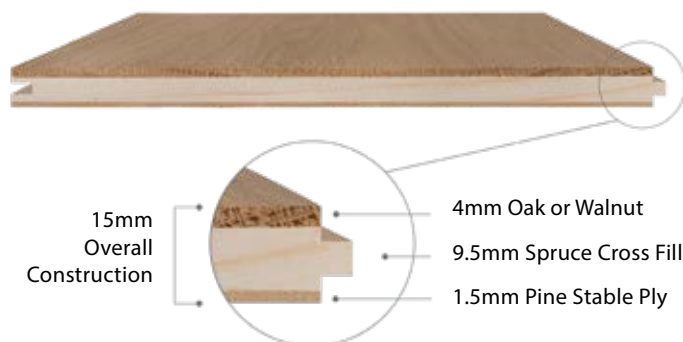

To view the complete Chêne Collection, scan the QR code using your smartphone.





LOWELL
SKU: QOUA417
White Oak (European)



THURMONT
SKU: QOUB557
White Oak (European)



COOPER
SKU: QOUW267
White Oak (European)



RANGELEY
SKU: QOUB437
White Oak (European)



TURNER
SKU: QOUD257
White Oak (European)



WESTON
SKU: QOUN307
White Oak (European)



GLENARDEN
SKU: QOUE567
White Oak (European)



BROCKWAY
SKU: QOUW277
White Oak (European)



HARVEY
SKU: QOUL317
White Oak (European)

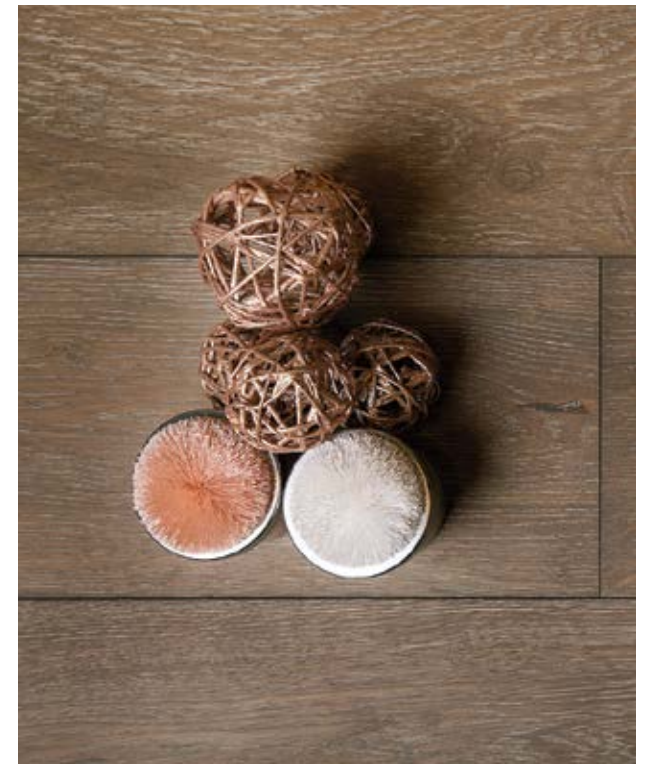

CHEVERLY
SKU: QOUB547
White Oak (European)

drift

COLLECTION

EARTHY ELEGANCE. MODERN TONES.
FILLED WITH EXCITING MOVEMENT.

The Drift Collection embraces the natural beauty and exciting visual movement found within wood. Each plank showcases wood's many lovely features such as knots, discoloration, and grain pattern. With unique tones and a matte finish, this collection has a refined earthiness, gentle sophistication, and a truly modern appeal.

2 LAYERED ENGINEERED CONSTRUCTION
Oak/Walnut

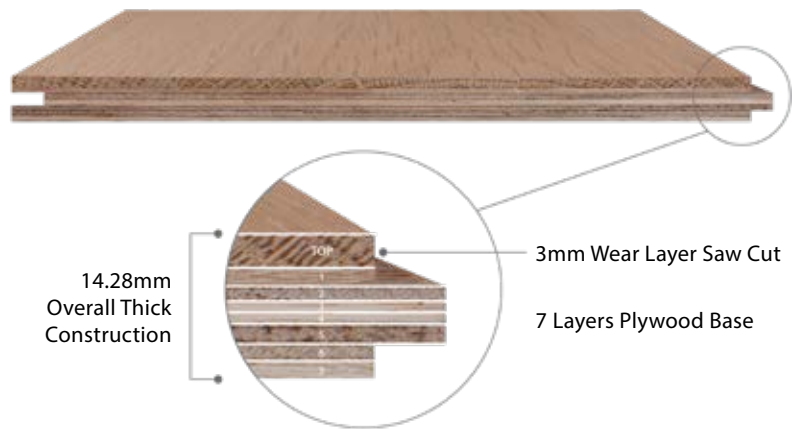

To view the complete Drift Collection, scan the QR code using your smartphone.



TORY BURCH

RIVER EDGE
SKU: ESDS67
Tory Burch, Hudson Yards, NYC



RIVER EDGE
SKU: ESDS67
White Oak (European)



LAMBERTVILLE
SKU: ESSO69
White Oak (European)



HEATHCOTE
SKU: ESRW74
American Walnut



WILDWOOD
SKU: ESWR73
American Walnut



RED BANK
SKU: ESRA71
White Oak (European)



MULLICA HILL
SKU: ESSB72
White Oak (European)



BAYONNE
SKU: ESBS79
White Oak (European)



TENAFLY
SKU: ESPB77
White Oak (European)



BLOOMFIELD
SKU: ESSD78
White Oak (European)



LEONIA
SKU: ESOM80
White Oak (European)



FREEHOLD
SKU: ESAB68
White Oak (European)



OCEAN GROVE
SKU: ESGD70
White Oak (European)



CRANBURY
SKU: ESSU81
White Oak (European)

Well-Treated

COLLECTION

CELEBRATING THE NATURAL BEAUTY OF WOOD.
ECO-FRIENDLY TREATMENTS.
CRAFTSMAN TRADITIONS.

The Well-Treated Collection embraces the craftsman traditions of smoking, fuming, and carbonizing wood. These natural and environmentally-friendly processes involve exposing wood to either heat (carbonizing), ammonia (fuming), or smoke. These treatments react with the tannins, sugars, and minerals found inside wood cells. It is this chemical reaction inside the wood's molecular structure that changes the color of the wood, altering or deepening the color for a desired effect. Visually, these treatment processes preserve the unique look of each piece of wood in stark contrast to the process of staining wood, which can hide many of the beautiful and natural qualities found in wood. Chiseled edges, hand-scraping, distressing, and worn finishes all contribute to the softly rustic, but elegant allure of the craftsman Well-Treated Collection.



To view the complete Well-Treated Collection, scan the QR code using your smartphone.



MARDIE
SKU: KULC19
Joe & The Juice | New York, NY & San Diego, CA



COWRA
SKU: KULG26
White Oak (European)



ELMA
SKU: KUCN31
White Oak (European)



CAMBALIN
SKU: KURW11
White Oak (European)



LANCELIN
SKU: KUAA15
White Oak (European)

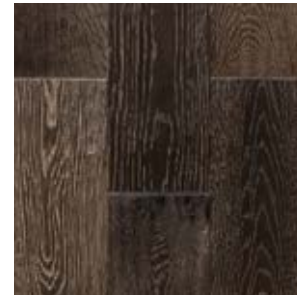

PARDOO
SKU: KUAE18
White Oak (European)



FREMANTLE
SKU: KUAH09
White Oak (European)



ALBURY
SKU: KULA25
White Oak (European)



LIMMEN
SKU: KURB12
White Oak (European)



FORBES
SKU: KULA27
White Oak (European)



MARDIE
SKU: KULC19
White Oak (European)

T*P

A LITTLE BIT OF EVERYTHING. CURATED TO PERFECTION. DISCOVER WHAT YOU LOVE.

The TOP Line is a thoughtfully curated “intro kit” of Engineered European hardwood flooring selections. Discover what you love without being overwhelmed by choice. This collection covers all the bases—whether you desire a look that is beautifully rustic and highlights the natural details of wood or whether you desire a cleaner, sleeker, more Scandinavian look and feel. Dark, light, herringbone, and plank—TOP Line has a little bit of everything and is the perfect introduction to the wide variety of beautiful options available in hardwood flooring.



To view the complete Top Line, scan the QR code using your smartphone.

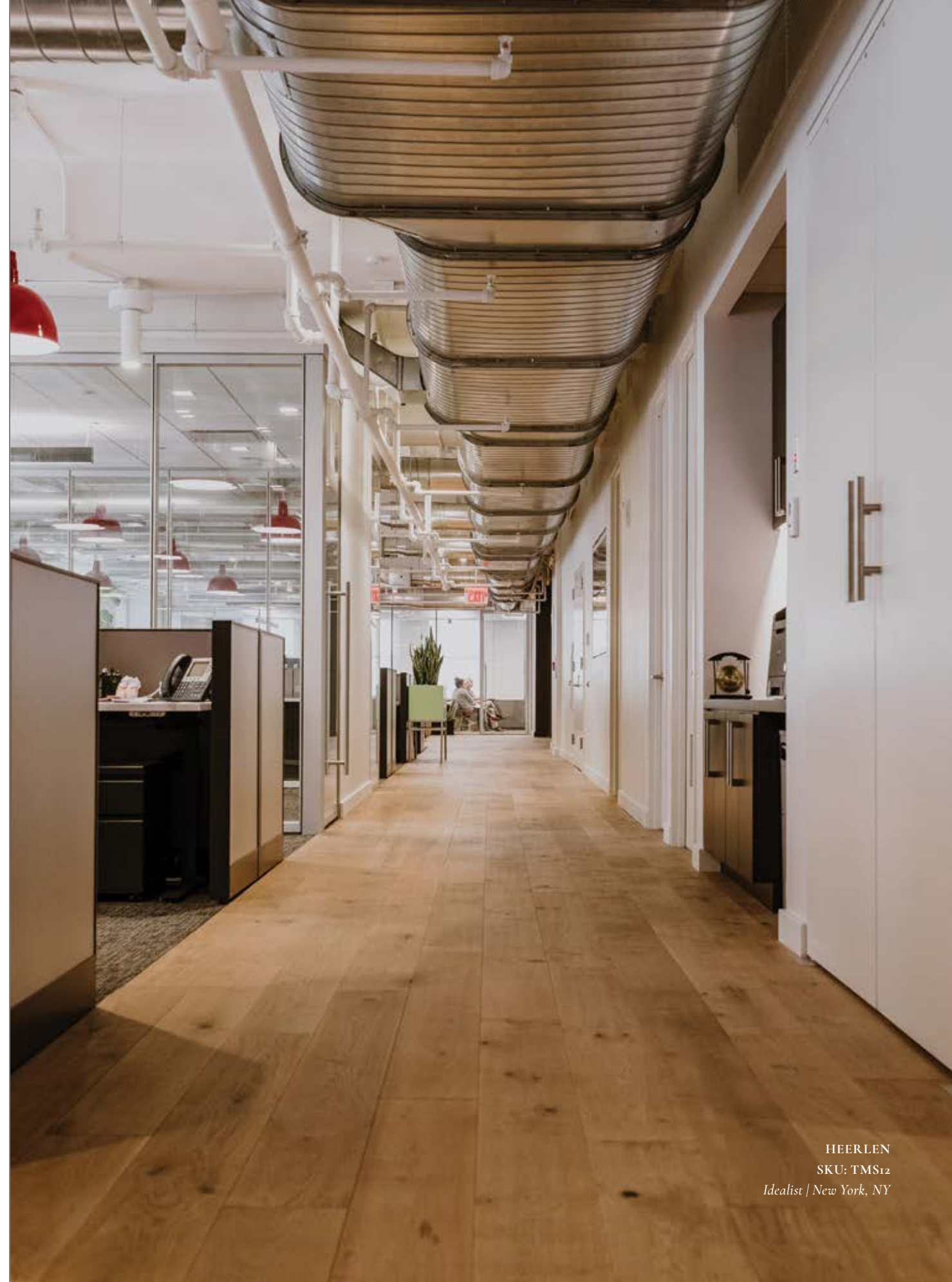

HEERLEN
SKU: TMS12
Idealist | New York, NY



GRONINGEN
SKU: TMA13
White Oak (European)



HILVERSUM
SKU: TMC18
White Oak (European)



DEVENTIER
SKU: TMN20
White Oak (European)



HEERLEN
SKU: TMS12
White Oak (European)



MONNICKENDAM
SKU: TMK56
White Oak (European)



EPHRATA
SKU: TMLG43
White Oak (European)



MUIDEN
SKU: TMU32
White Oak (European)



NAAREN
SKU: TMC11
White Oak (European)



LEIDEN
SKU: TMC04
White Oak (European)



BRIELLE
SKU: TMP61
White Oak (European)



EMMAUS
SKU: TMVK45
White Oak (European)



DELFT
SKU: TMK03
White Oak (European)



NIJMEGEN
SKU: TMC14
White Oak (European)



OOSTERHOUT
SKU: TMNS55
White Oak (European)

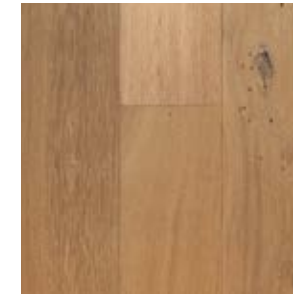

TEXEL
SKU: TMSU62
White Oak (European)



VENLO
SKU: TMA07
White Oak (European)



BERWICK
SKU: TMLC41
White Oak (European)



BREDA
SKU: TMN06
White Oak (European)



KUINRE
SKU: TMA19
White Oak (European)



AMERSFOORT
SKU: TME17
White Oak (European)

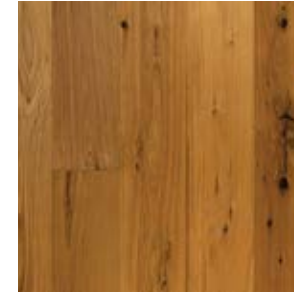

ZILK
SKU: TMPN59
White Oak (European)



ZWOLLE
SKU: TMV05
White Oak (European)

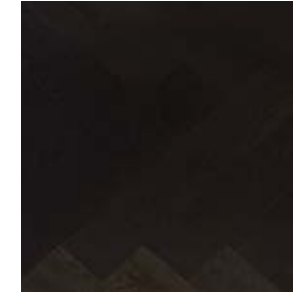

ALKMAR
SKU: TML25
White Oak (European)



LELYSTAD
SKU: TMW26H
White Oak (European)



KERKRADE
SKU: TMNH10
White Oak (European)



HAARLEM
SKU: TMW15
White Oak (European)



MAASTRICHT
SKU: TMV16
White Oak (European)

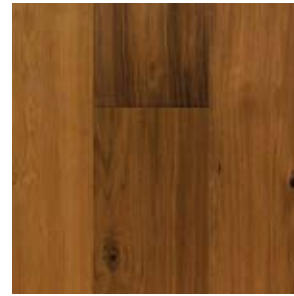

MEPPEL
SKU: TMSN60
White Oak (European)



GELEEN
SKU: TMC63C
White Oak (European)



LISSE
SKU: TMC27
White Oak (European)



BELFELD
SKU: TMP54H
White Oak (European)

board COLLECTION

WIDE PLANK. LONG BOARD.

ICONIC BEAUTY. EUROPEAN WHITE OAK.

The Board Collection showcases the singular beauty of Wide Plank, Long Board, Hardwood Flooring. Made from European White Oak, these are truly showcase floors, each plank measuring nine-feet-long and up to nearly 12-inches-wide, providing a powerful aesthetic presence in any space. Utilization of the full log means each hardwood plank will have true character, displaying its full individual beauty. The width and length of these beautiful boards also provide a structural advantage, offering unparalleled balance and stability, to every Board Collection floor.

3 LAYERED ENGINEERED CONSTRUCTION

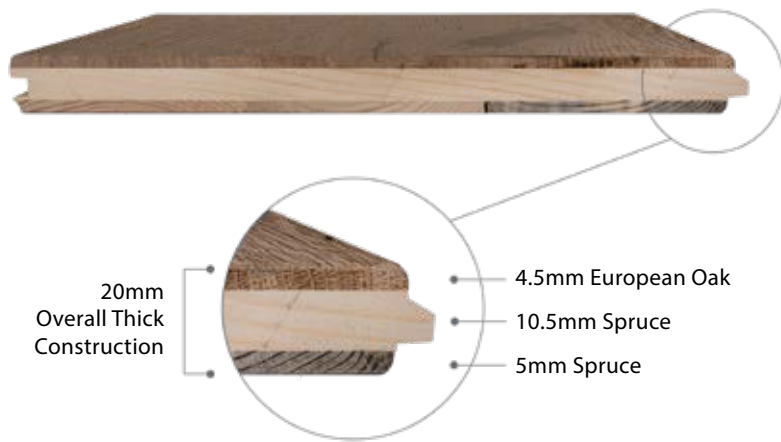

To view the complete Board Collection, scan the QR code using your smartphone.





TRANBY
SKU: COCT34
White Oak (European)



ALESUND
SKU: COCW28
White Oak (European)



LANDE (NATURAL COLOR)
SKU: COCN23
White Oak (European)



KRISTIANSUND
SKU: COCJ30
White Oak (European)



DRAMMEN
SKU: COCS25
White Oak (European)



MOLDE
SKU: COCC26
White Oak (European)



BERGEN
SKU: COCG27
White Oak (European)



TRONDHEIM
SKU: COCP29
White Oak (European)



HISTORICAL BEAUTY.

SUSTAINABLE SOPHISTICATION.

Our Reclaimed Collection is an environmentally friendly gathering of antique reclaimed wood salvaged from dismantled wooden structures found all around the world including 17th and 18th century European Farmhouses, American Barns, and fence posts. This collection is made from 100% pre- or post-consumer recycled material. Every piece of reclaimed wood is truly one-of-a-kind and possesses both historical and sustainable allure.



To view the complete Reclaimed Collection, scan the QR code using your smartphone.





XENIA (NATURAL COLOR)
SKU: ML20RWOSR
Reclaimed



BROADVIEW HEIGHTS (NATURAL COLOR)
SKU: ML18RHPSR
Reclaimed



CORTLAND (NATURAL COLOR)
SKU: ML19RHPSR
Reclaimed



AVON BLAKE (NATURAL COLOR)
SKU: ML17RDFS
Reclaimed



OBERLIN
SKU: ML01MHCSR
Reclaimed

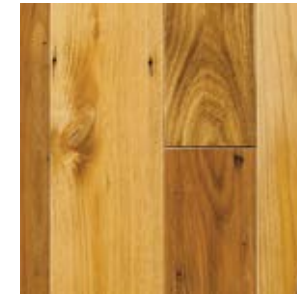

MARLINGTON
SKU: CHL109
Reclaimed



HUTTONSVILLE
SKU: CHL108
Reclaimed



GASSAWAY
SKU: CHL107
Reclaimed



BRECKSVILLE
SKU: ML15EWASR
Reclaimed



WICKLIFFE
SKU: ML14MRSSR
Reclaimed



DARRTOWN
SKU: ML13TWOSR
Reclaimed



GRANVILLE
SKU: ML10VWLSR
Reclaimed



FLEMINGTON
SKU: CHL106
Reclaimed



ELLENBORO
SKU: CHL105
Reclaimed



DELBARTON
SKU: CHL104
Reclaimed



CHAPMANVILLE (UNSTAINED)
SKU: CHL103
Reclaimed

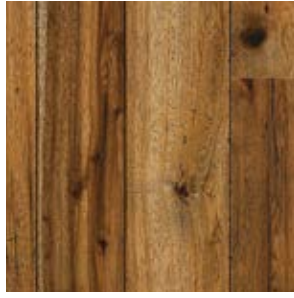

SANDUSKY
SKU: ML09VRSSR
Reclaimed

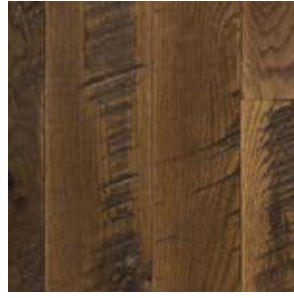

CHILLICOTHE
SKU: ML08VWTSR
Reclaimed



TIPP CITY
SKU: ML07MWPSR
Reclaimed



LIMA
SKU: ML06MWISR
Reclaimed

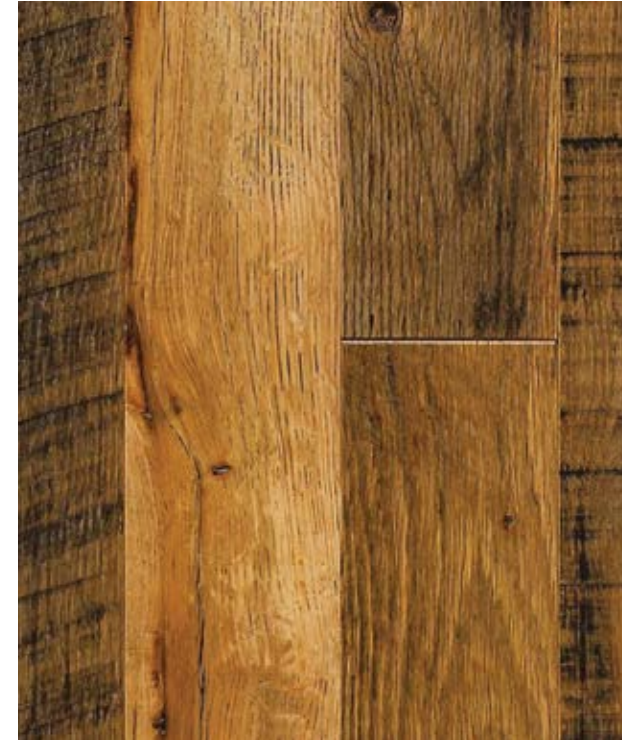

BLACKSVILLE (UNSTAINED)
SKU: CHL102
Reclaimed



ALBRIGHT (UNSTAINED)
SKU: CHL101
Reclaimed



LOUDONVILLE
SKU: ML05MWESR
Reclaimed



WOOSTER
SKU: ML04MRCSR
Reclaimed



MARBLEHEAD
SKU: ML03MTWSR
Reclaimed



ZANESVILLE
SKU: ML02MWSSR
Reclaimed



ARTISANAL ELEGANCE.

TRADITIONAL CRAFTSMANSHIP.

PID Floors is proud to embrace the time-old tradition of creating herringbone and chevron parquet hardwood floors whose origins date back to 16th Century Europe. Our bespoke services offer you the ability to create herringbone or chevron floors according to your exact specifications, desires, and needs. Whether purely traditional or radically modern, we will make your parquet floor however you imagine it, in any of our wonderful finishes.



To view the complete Chevron/Herringbone Collection, scan the QR code using your smartphone.



GARRETT PARK HERRINGBONE
SKU: QOUB₄₅, QOUB₅₀
78 Amity St. Brooklyn, NY



LELYSTAD HERRINGBONE
SKU: TMW26H
White Oak (European)



LISSE
SKU: TMC27
White Oak (European)

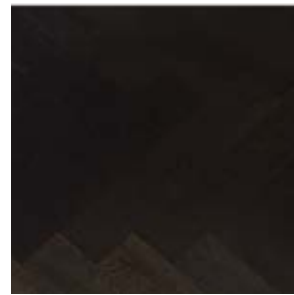

ALKMAR
SKU: TML25
White Oak (European)



BELFELD
SKU: TMP54H
White Oak (European)

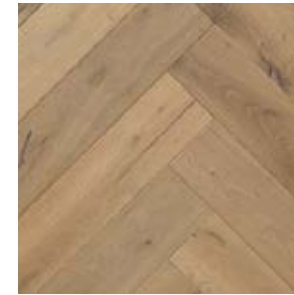

GUSTINE
SKU: WG30117
White Oak (European)



FUNEN
SKU: PLCL76
White Oak (European)



AARHUS
SKU: PLCD74
White Oak (European)



VEJLE
SKU: PLCG75
White Oak (European)



LELYSTAD CHEVRON
SKU: TMW26C
White Oak (European)



GELEEN
SKU: TMC63C
White Oak (European)



POOLESVILLE
SKU: QOUC51
White Oak (European)



GARRET PARK
SKU: QOUB50
White Oak (European)



VIAREGGIO
SKU: YPAC336
White Oak (European)



LEGNANO
SKU: YPAC337C
White Oak (European)



BENEVENTO
SKU: YPAC339C
White Oak (European)



OLBIA
SKU: YPAC338
White Oak (European)



TANEYTOWN
SKU: QOUM49
White Oak (European)



HOLDEN
SKU: QOUP67
White Oak (European)



ATKINSON
SKU: QOUT68
White Oak (European)



MONTGOMERY
SKU: ASO100-4RC
White Oak (North American)



LEGNANO
SKU: YPAC337H
White Oak (European)

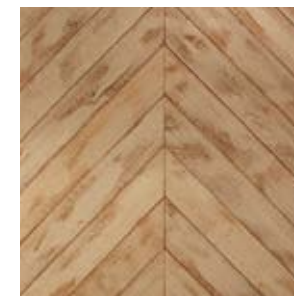

PARQUET
SKU: PF054



FLAME
SKU: MRF11C
White Oak (European)



CANTATA
SKU: MRF3669C
White Oak (European)



JOLON (NATURAL COLOR)
SKU: GN20137H
White Oak

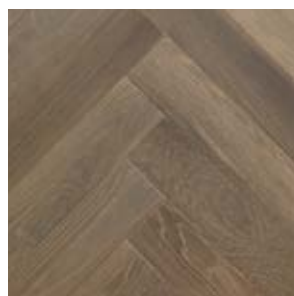

GLENN
SKU: GN20120H
White Oak (European)



AMADOR
SKU: WG30118
White Oak (European)

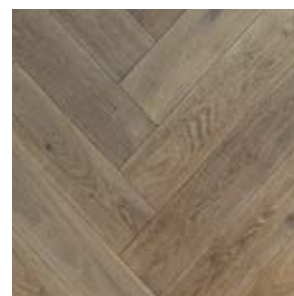

ENCINO
SKU: WG30132O
White Oak (European)



GLORY
SKU: MRFFR71215
White Oak (European)



MIRACLE
SKU: MRF19C
White Oak (European)



DESIGN
SKU: MRF08C
White Oak (European)



PROVIDENCE
SKU: ASC1650-3PC
White Oak (North American)

FINELOCK

COLLECTION

HIGH QUALITY. PRICE-FRIENDLY.

MODERN LENGTHS. TRADITIONAL COLORS.

The Finelock Collection is focused on offering a high-quality longer length hardwood floor at accessible prices. Made from fine European Oak and Ash which has been cut into long length click-system plank flooring, this collection comes in over thirty classically beautiful tones. The Finelock Collection embraces modernity, tradition, and practicality: longer length floors available in a generous selection of traditional and timeless colors, offered at a friendly price point, and always in stock.

3 LAYERED ENGINEERED CONSTRUCTION
Oak
Width: 8" - 1/8" (207mm)

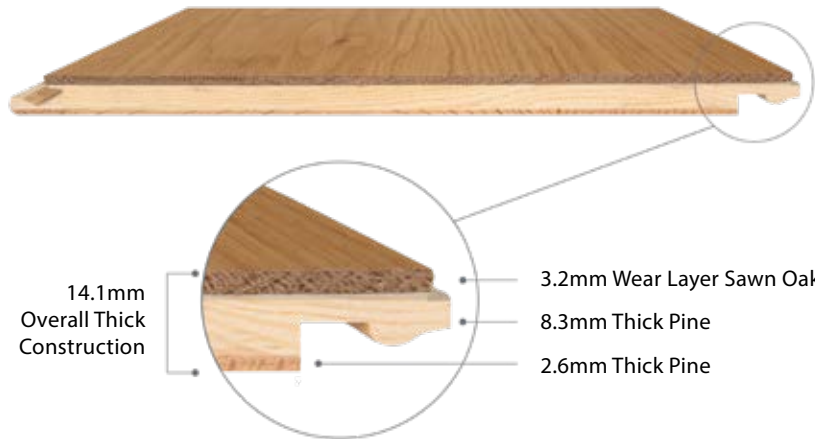

To view the complete Finelock Collection, scan the QR code using your smartphone.





PANOLA
SKU: LFO58720
White Oak (European)



WESTFORK
SKU: LFO37820
White Oak (European)



AUSTELL
SKU: LFO17820
White Oak (European)



WYNFORD
SKU: LFO48720
White Oak (European)



WOOLSEY
SKU: LFO01720
White Oak (European)



ALEXIS
SKU: LFO45720
White Oak (European)



VIDETTE
SKU: LFO83520
White Oak (European)



TYBEE
SKU: LFO38220
White Oak (European)



KELLOGG
SKU: LFO67820
White Oak (European)



LESLIE
SKU: LFO47820
White Oak (European)



CHAUNCEY
SKU: LFO57820
White Oak (European)

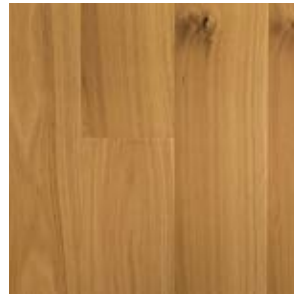

NEWMAN
SKU: LFO67720
White Oak (European)



OCONEE
SKU: LFO87020F
White Oak (European)



CONYERS
SKU: LFO96820
Ash



MILNER
SKU: LFO05520
White Oak (European)



MOLENA
SKU: LFO49720
White Oak (European)



RUTLEDGE
SKU: LFO86820
Ash



GWINNETT
SKU: LFO56620
White Oak (European)



LIZELLA
SKU: LFO62620
White Oak (European)



TERRELL
SKU: LFO93520
White Oak (European)

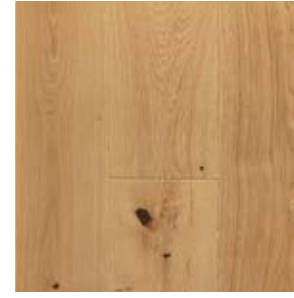

ALLON
SKU: LFO58220
White Oak (European)



WADLEY
SKU: LFO31820
White Oak (European)



HARALSON
SKU: LFO48220
White Oak (European)



PEACHTREE
SKU: LFO46820
White Oak (European)



TOCCOA
SKU: LFO16620
White Oak (European)



LENOIR
SKU: LFO67620
Ash



SCOTIA
SKU: LFO73820
Ash



STILLMORE
SKU: LFO00720
White Oak (European)



COMER
SKU: LFO66820
White Oak (European)



FLOVILLA
SKU: LFO56820
White Oak (European)



IVEY
SKU: LFO26820
White Oak (European)



ORCHARD HILL
SKU: LFO36820
White Oak (European)

Crave

COLLECTION

NORTH AMERICAN OAK.

DOMESTIC MANUFACTURING.

ULTRA MATTE, CLEAN, AND MODERN.

The Crave Collection supports domestic manufacturing and is sourced, designed, produced, and finished entirely in the United States. Made from North American White Oak which has been grown in responsibly managed forests, this line has been exquisitely milled. It is made complete with an Ultra Matte American-Made Finish. This collection, which comes in ten beautifully versatile colors, is clean, modern, and elegant.

2 LAYERED ENGINEERED CONSTRUCTION



To view the complete Crave Collection, scan the QR code using your smartphone.





MORAINES UM
SKU: RS1629T1F-C
White Oak (North American)



ASHLAND UM
SKU: RS1172T1F-C
White Oak (North American)



CHARDON UM
SKU: RS1120T4F-C
White Oak (North American)



PELICAN UM
SKU: RS1083T1F-C
White Oak (North American)



STUART UM
SKU: RS1032T1F-CRQ
White Oak (North American)



SEBRING UM
SKU: RS993T3F-CRQ
White Oak (North American)

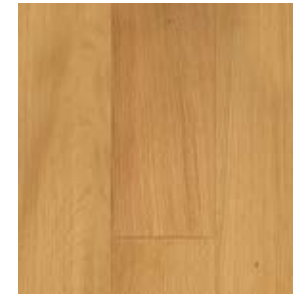

MORAINES UM
SKU: RS1629T1F-CRQ
White Oak (North American)



ASHLAND UM
SKU: RS1172T1F-CRQ
White Oak (North American)



STUART UM
SKU: RS1032T1F-C
White Oak (North American)



SEBRING UM
SKU: RS993T3F-C
White Oak (North American)



PATASKALA UM
SKU: RS981T1F-CS
White Oak (North American)



CIRCLEVILLE UM
SKU: RS892T1F-C
White Oak (North American)



CELINA UM
SKU: RS1782T2F-CRQ
White Oak (European)



CHARDON UM
SKU: RS1120T4F-CRQ
White Oak (North American)



COSHOCTON UM
SKU: RS890T3F-CRQ
White Oak (North American)



CIRCLEVILLE UM
SKU: RS892T1F-CRQ
White Oak (North American)



COSHOCTON UM
SKU: RS890T3F-C
White Oak (North American)



BELPRE UM
SKU: RS1024T4F-C
White Oak (Normal American)



WAYNE UM
SKU: RS1784T2F-C
White Oak (North American)



CELINA UM
SKU: RS1782T2F-C
White Oak (North American)



PELICAN UM
SKU: RS1083T1F-CRQ
White Oak (North American)



WAYNE UM
SKU: RS1784T2F-CRQ
White Oak (North American)



CELINA UM
SKU: RS1782T2F-CH
White Oak (European)



WAYNE UM
SKU: RS1784T2F-CV
White Oak (European)



PATASKALA UM
SKU: RS981T1F-CSRQ
White Oak (North American)



BELPRE UM
SKU: RS1024T4F-CRQ
White Oak (North American)

RQ VI COLLECTION

RIFT & QUARTERED AMERICAN OAK. FINEST QUALITY. TIMELESS LUXURY.

The R&Q VI Collection embodies timeless luxury and celebrates the beauty of America's National Tree, the Oak. These beautiful floors are made from Rift & Quarter Sawn White Oak which was domestically sourced from forests in Kentucky and Ohio. Rift & Quarter Sawn is highly regarded for both its straight grain aesthetic and floorboard stability. This collection is further elevated with its six-inch widths and longer lengths. Limited knots and variation of pattern create an elegant minimalist look and feel which is completed with a Smooth Matte American-Made Finish.

2 LAYERED ENGINEERED CONSTRUCTION

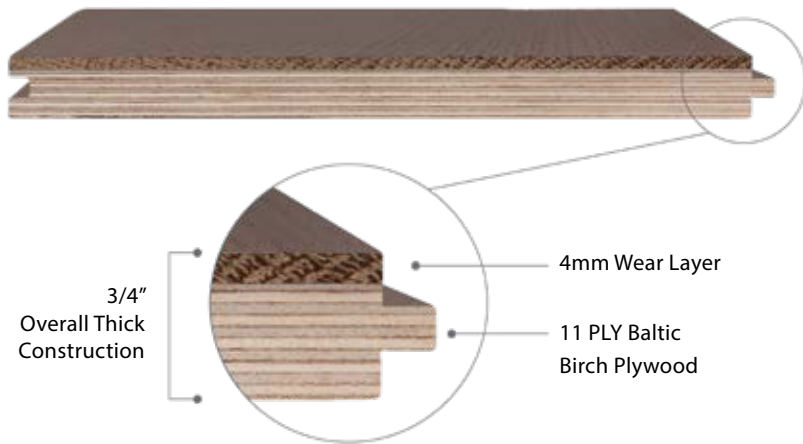

To view the complete RQ VI Collection, scan the QR code using your smartphone.

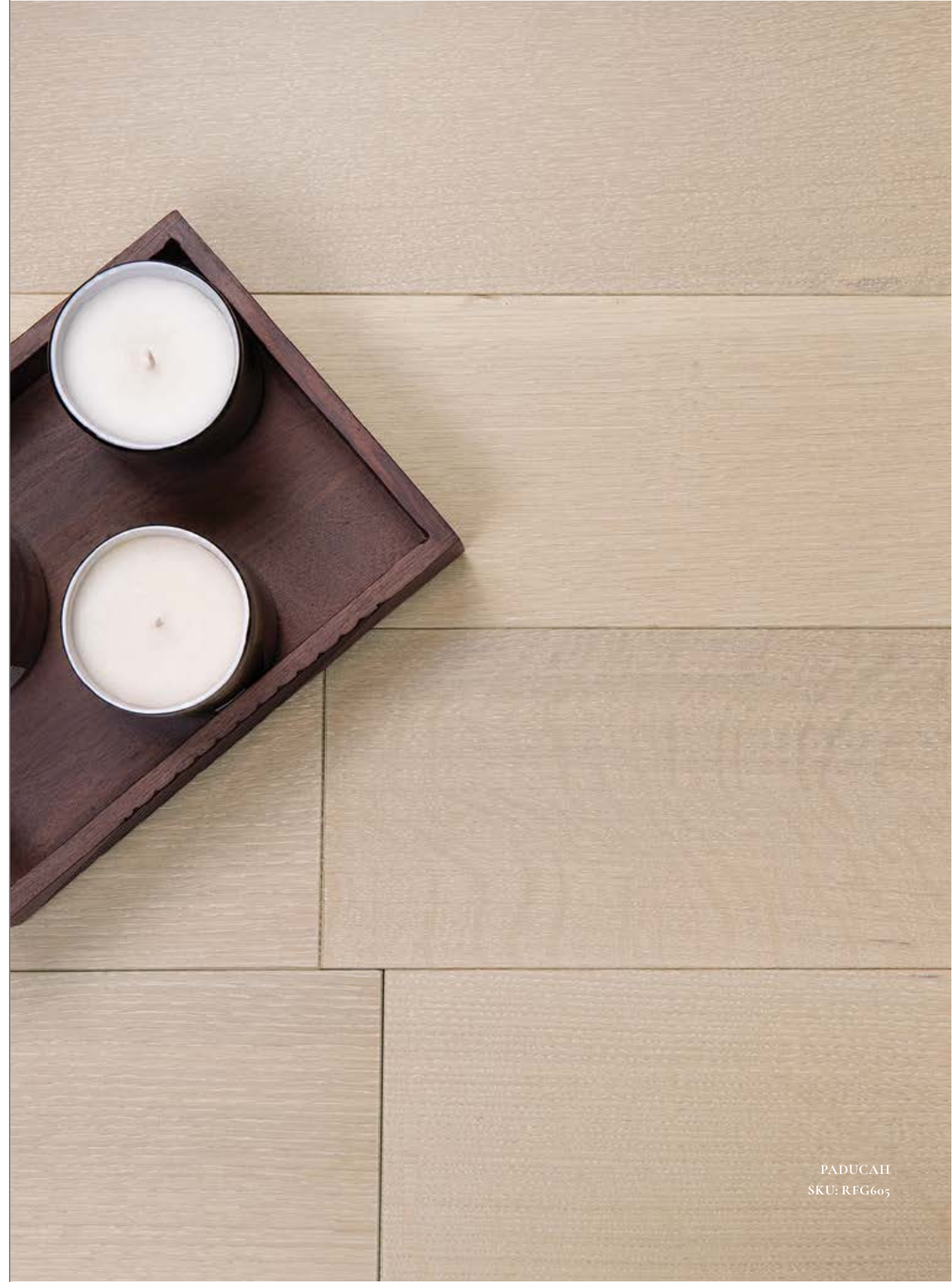



ETNA
SKU: VS17102
White Oak (North American)



MAUK
SKU: VS17207
White Oak (North American)



LULA (NATURAL COLOR)
SKU: VS17101
White Oak (North American)



SHIVELY (NATURAL COLOR)
SKU: RFG601
White Oak (American)



COSHOCTON UM
SKU: RS890T3F-CRQ
White Oak (North American)



PELICAN UM
SKU: RS1083T1F-CRQ
White Oak (North American)

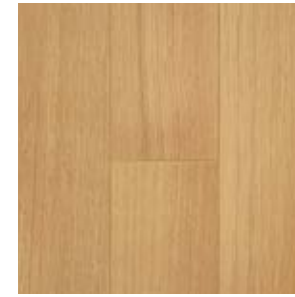

PATASKALA UM
SKU: RS981T1F-CSRQ
White Oak (North American)

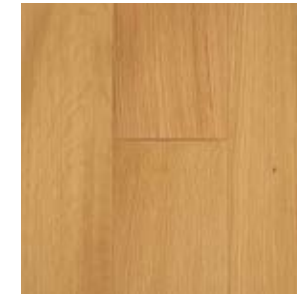

MORAINE UM
SKU: RS1629T1F-CRQ
White Oak (North American)



HOPKINSVILLE
SKU: RFG602
White Oak (American)



GEORGETOWN
SKU: RFG603
White Oak (American)



HENDERSON
SKU: RFG604
White Oak (American)



PADUCAH
SKU: RFG605
White Oak (American)



SEBRING UM
SKU: RS993T3F-CRQ
White Oak (North American)



STUART UM
SKU: RS1032T1F-CRQ
White Oak (North American)



RADCLIFF
SKU: RFG606
White Oak (American)



DANVILLE
SKU: RFG607
White Oak (American)



OWENSBORO
SKU: RFG608
White Oak (American)



CELINA UM
SKU: RS1782T2F-CRQ
White Oak (North American)



CHARDON UM
SKU: RS1120T4F-CRQ
White Oak (North American)



WAYNE UM
SKU: RS1784T2F-CRQ
White Oak (North American)



ASHLAND UM
SKU: RS1172T1F-CRQ
White Oak (North American)



BELPRE UM
SKU: RS1024T4F-CRQ
White Oak (North American)



CIRCLEVILLE UM
SKU: RS892T1F-CRQ
White Oak (North American)



ARTISANAL LUXURY.

ENDLESS CREATIVITY.

PID Floors' skilled craftsmen possess the talent, vision, and experience to transform your home into a beautiful work of art. All of our medallions and inlays are custom designed and made by hand. Our craftsmen are masters in both the art of traditional handcrafting parquet techniques and the latest in modern laser-cutting technology, giving you access to the best of both worlds—the old and the new.



To view the complete Parquet Collection, scan the QR code using your smartphone.





ELKVILLE
SKU: EWLM96P
White Oak (European)



BARTLETT
SKU: EWLM95P
White Oak (European)



MAKANDA
SKU: EWLC92P
White Oak (European)



TOULON
SKU: EWLO94P
White Oak (European)



JOLIET
SKU: EWLL93P
White Oak (European)



PEORIA
SKU: EWLC91P
White Oak (European)



RINGSTED
SKU: PLEF72
White Oak



SKIVE
SKU: PLER71
White Oak



HILLEROD
SKU: PLEB73
White Oak



BELLFLOWER
SKU: WG30101O
White Oak (European)



PICO RIVERA
SKU: WG30102O
White Oak (European)



HIGHLAND
SKU: WG30108O
White Oak (European)



MOGILEV
SKU: DTPWT1985
White Oak (European)



MIORY
SKU: DTPMT1971
White Oak (European)



HEXAGON MEDALLION
SKU: MO005



OCTAGON MEDALLION
SKU: MO009



GLORY PARQUET
SKU: MRF13PQ1



GLORY PARQUET
SKU: MRF13PG01



PARQUET
SKU: PF046



**SMOKED OAK & OIL
PARQUET**
SKU: MRF39PQ11

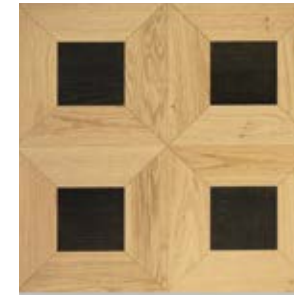

**GLORY + SOPHISTICATION
PARQUET**
SKU: MRF1327PQ4



**GLORY + SOPHISTICATION
PARQUET**
SKU: MRF1327PQ3



**SMOKED OAK & OIL
PARQUET**
SKU: MRF45PFER1



CHARM RAVNO PARQUET
SKU: MRF06PWOOD1
White Oak



DESIGN PARQUET
SKU: MRF08PQ8
White Oak



OCTAGON MEDALLION
SKU: MO002



OCTAGON MEDALLION
SKU: MO003



OCTAGON MEDALLION
SKU: MO006



CORNER
SKU: MC004



CORNER
SKU: MC003



CORNER
SKU: MC002



CORNER
SKU: MC005



A behind-the-scenes look at the meticulous craftsmanship involved in the creation of this beautiful 12-foot Custom Parquet Medallion.



Pure

COLLECTION

EUROPEAN OAK. AMERICAN FINISH.

EXCEPTIONALLY SMOOTH.

ULTRA MATTE. UNPARALLELED.

The Pure Collection is the embodiment of sophisticated simplicity. These exquisite Wide Plank Hardwood Floors are made from Pure and Natural Grade European Oak. With small knots and subtle variation of pattern, these floors are given a softly rustic and minimalist canvas which are then completed with an Ultra Matte American Finish. This Ultra Matte Finish is unparalleled—creating the smoothest, softest look and feel. The Pure Collection's smooth surface reminds us of the beauty of a perfectly still lake reflecting the gentle light at dawn.



To view the complete Pure Collection, scan the QR code using your smartphone.





ELON
SKU: PEG20352
White Oak (European)



FAISON
SKU: PEG20351
White Oak (European)



SWEPSON
SKU: PEG20349
White Oak (European)



JUDSON
SKU: PEG20350
White Oak (European)



BOLTON
SKU: PEG20306
White Oak (European)



DOBSON
SKU: PEG20348
White Oak (European)

Selected *Collection*

SELECT & BETTER GRADE.
USUALLY IN STOCK.

The Selected Collection is a thoughtful curation of Oak, Ash, and Walnut Select Grade Hardwood Flooring which has been sourced from all around the world and is kept in stock for quick and easy delivery. Select Grade is one of the highest grades of wood flooring, prized for having a more uniform appearance, softer color variations, and an absence of knots and cracks, while still showcasing the natural beauty and movement of wood.



To view the complete Selected Collection, scan the QR code using your smartphone.





LENTVARIS
SKU: FM2108
White Oak (European)

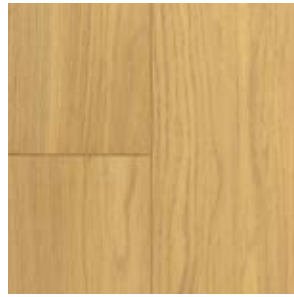

PALANGA
SKU: FM2106
White Oak (European)



JONAVA
SKU: FM2112
White Oak (European)



ALYTUS
SKU: FM2107
White Oak (European)

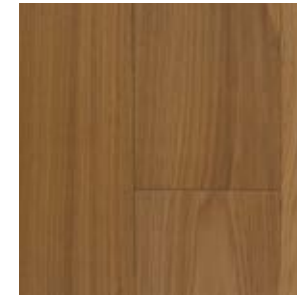

MILLUX
SKU: GN20165
White Oak (European)

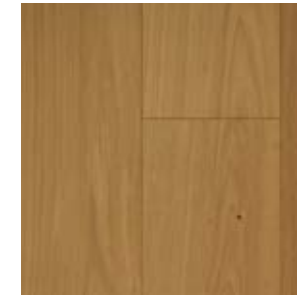

SACO
SKU: GN20147
White Oak (European)



VIOLA
SKU: GN20163
White Oak (European)



ORLAND
SKU: GN20177
White Oak (European)



EL MONTE
SKU: WG30109
White Oak (European)



GLENARDEN
SKU: QOUE567
White Oak (European)



ETNA
SKU: VS17102
White Oak (North American)

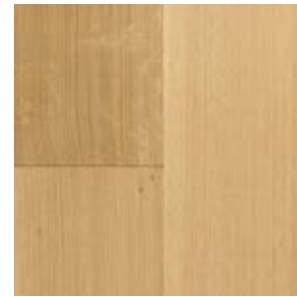

LULA (NATURAL COLOR)
SKU: VS17101
White Oak (North American)

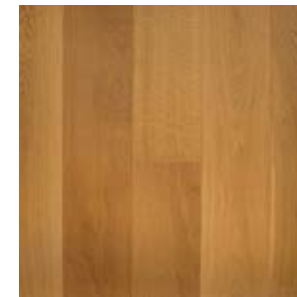

GILROY
SKU: GN20196
White Oak (European)

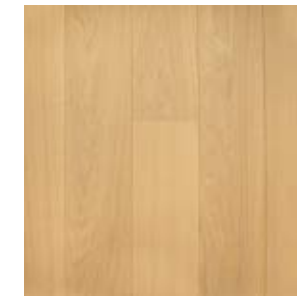

POZO
SKU: GN20179
White Oak (European)

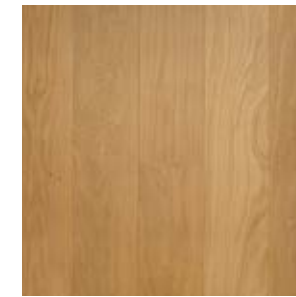

POSEY
SKU: GN20173
White Oak (European)



ZENIA
SKU: GN20192
White Oak (European)



MAUK
SKU: VS17207
White Oak (North American)

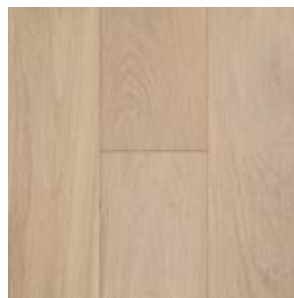

MELLO
SKU: GN20140
White Oak (North American)



OPHIR
SKU: GN20143
White Oak (North American)



LODI
SKU: GN20152
White Oak (North American)



ARVIN
SKU: GN20168
White Oak (European)



KEENE
SKU: GN20149
White Oak (European)



LOLETA
SKU: GN20162
White Oak (European)



ELKTON
SKU: OBO136
European Ash



MARIGOLD
SKU: GN20144
White Oak (European)



DELUZ
SKU: GN20153
White Oak (European)

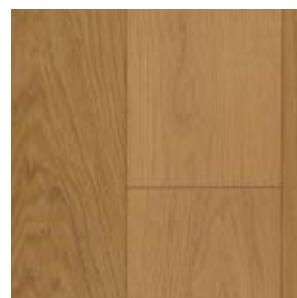

SOMIS
SKU: GN20157
White Oak (European)



DULAH
SKU: GN20159
White Oak (European)



ELDORA
SKU: OBO130
European Ash

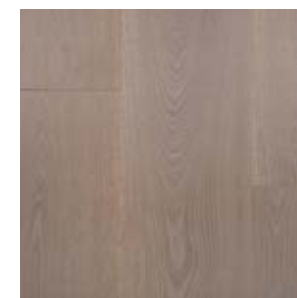

OZELLO
SKU: OBO129
European Ash

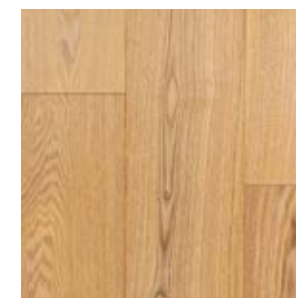

FELDA
SKU: OBO127
European Ash



PAMPLOMA
SKU: SWP103
White Oak (European)

TANDEM
OAK
COLLECTION

OAK TOP. OAK BOTTOM.

ULTRA-STABLE. ULTRA-BALANCED.

Introducing the NEW Tandem Oak Collection. Uniquely designed with an identical Oak Top and Bottom layer, both of which surround a sturdy Baltic Plywood middle layer, this collection offers an ultra-stable and ultra-balanced three-layer floor. Made from North American White Oak which has been grown in responsibly managed forests, this collection embraces the trend of domestic manufacturing and has been exquisitely designed, produced, milled, and finished entirely in the United States. The Tandem Oak Collection is available for your complete customization.



To view the complete Tandem Oak Collection, scan the QR code using your smartphone.





CREMONA
SKU: YPAC333
White Oak (European)



PERUGIA (NATURAL COLOR)
SKU: YPAC318
White Oak (European)



BRESCIA (NATURAL COLOR)
SKU: YPAC316
Walnut (European)



VINCENZA
SKU: YPAC324
White Oak (European)



PESCARA
SKU: YPAC326
White Oak (European)



PLACENZA
SKU: YPAC325
White Oak (European)



GENOA
SKU: YPAC312
Larch



PALERMO (NATURAL COLOR)
SKU: YPAC311
Larch



VIAREGGIO
SKU: YPAC336
White Oak (European)



LUCCA
SKU: YPAC332
White Oak (European)



LIVORNO
SKU: YPAC320
White Oak (European)



MODENA (NATURAL COLOR)
SKU: YPAC317
Wenge



BENEVENTO
SKU: YPAC339C
White Oak (European)



POMEZIA
SKU: YPAC335
White Oak (European)

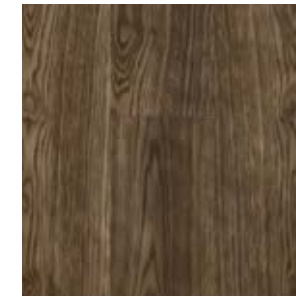

LA SPEZIA
SKU: YPAC331
White Oak (European)



FORLI
SKU: YPAC323
White Oak (European)



TARANTO
SKU: YPAC315
Walnut (European)



MESSINA
SKU: YPAC314
Walnut (European)



LEGNANO
SKU: YPAC337C
White Oak (European)



TRAPANI
SKU: YPAC334
White Oak (European)



MONZA
SKU: YPAC322
White Oak (European)



RAVENNA
SKU: YPAC319
White Oak (European)

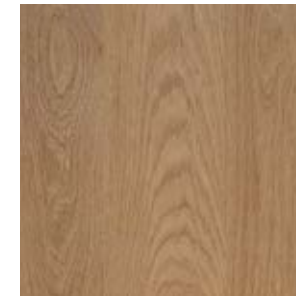

STAMFORD
SKU: XXWP101
White Oak (North American)



DANBURY
SKU: XXWR201
White Oak (North American)



BERGAMO
SKU: YPAC327
White Oak (European)



BARI (NATURAL COLOR)
SKU: YPAC313
Larch



OLBIA
SKU: YPAC338
White Oak (European)



CASORIA
SKU: YPAC329
White Oak (European)



SHELTON
SKU: XXWQ401
White Oak (North American)



BENEVENTO
SKU: YPAC339H
White Oak (European)

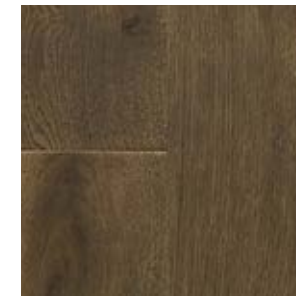

CATANZARO
SKU: YPAC330
White Oak (North American)



FIUMICINO
SKU: YPAC328
White Oak (European)

COLLECTION WALNUT

LUXURIOUS APPEAL. VISUAL MOVEMENT.

NEW AND EXCLUSIVE COLORS.

The Walnut Collection focuses entirely on the singular natural beauty of Walnut. Real Walnut Wood is renowned for its exciting visual movement and its luxurious appeal. We've worked with our finishers, located all around the world, to create unique and exquisite colors of Walnut, exclusive only to us. Walnut Floors are always showcase floors and we invite you to indulge in the true elegance of The Walnut Collection.



To view the complete Walnut Collection, scan the QR code using your smartphone.



UNFINISHED WALNUT CHEVRON



HEATHCOTE
SKU: ESRW74
American Walnut



WILDWOOD
SKU: ESWR73
American Walnut



PIKEVILLE
SKU: KC09
Walnut



NICHOLASVILLE
SKU: KC07
Oak



BRISTOL
SKU: XXWP301
American Walnut

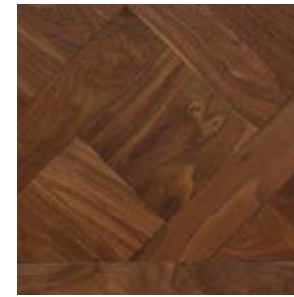

PEMBROKE (NATURAL COLOR)
SKU: DTMWW06
American Walnut



VAUGHAN
SKU: DTMWC07
American Walnut

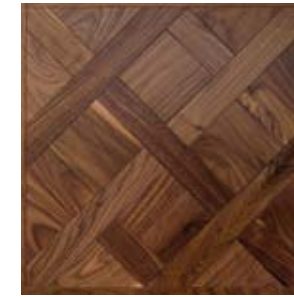

WELLAND (NATURAL COLOR)
SKU: DTMWT08
American Walnut



ERLANGER
SKU: KC04
Walnut



CADIZ
SKU: KC03
Walnut



TARPON SPRINGS
SKU: OBO73
Walnut



EDINA (NATURAL COLOR)
SKU: ASWN01
American Walnut



GRAVENHURST (NATURAL COLOR)
SKU: DTMWW14
American Walnut



GRIMSBY
SKU: DTMWC15
American Walnut



LATCHFORD (NATURAL COLOR)
SKU: DTMWT16
American Walnut



ORANGEVILLE (NATURAL COLOR)
SKU: DTMWW19
American Walnut



HOPKINS (NATURAL COLOR)
SKU: ASL906-5P
American Walnut



GOODVIEW
SKU: ASW907
American Walnut



MESSINA
SKU: YPAC314
Walnut (European)



TARANTO
SKU: YPAC315
Walnut (European)



BRESCIA (NATURAL COLOR)
SKU: YPAC316
Walnut (European)



TROMSO
SKU: COCWA56
American Walnut

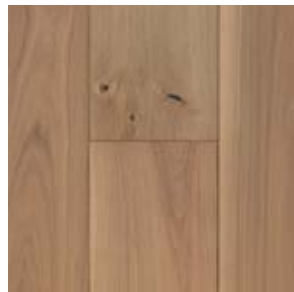

LOMPOC
SKU: WG301211
American Walnut



CAJON
SKU: WG301212
American Walnut



UNFINISHED

COLLECTION

BEAUTIFUL RAW WOOD.

CUSTOMIZED BY US, FINISHED BY YOU.

Our Unfinished Collection provides the opportunity for Customized Raw Wood Floors to be finished on-site. We maintain an extensive inventory of Unfinished Wood in-stock and will produce to any desired specification including Wood Species, Construction, Cut, Grade, Dimensions, and more.



To view the complete Unfinished Collection, scan the QR code using your smartphone.

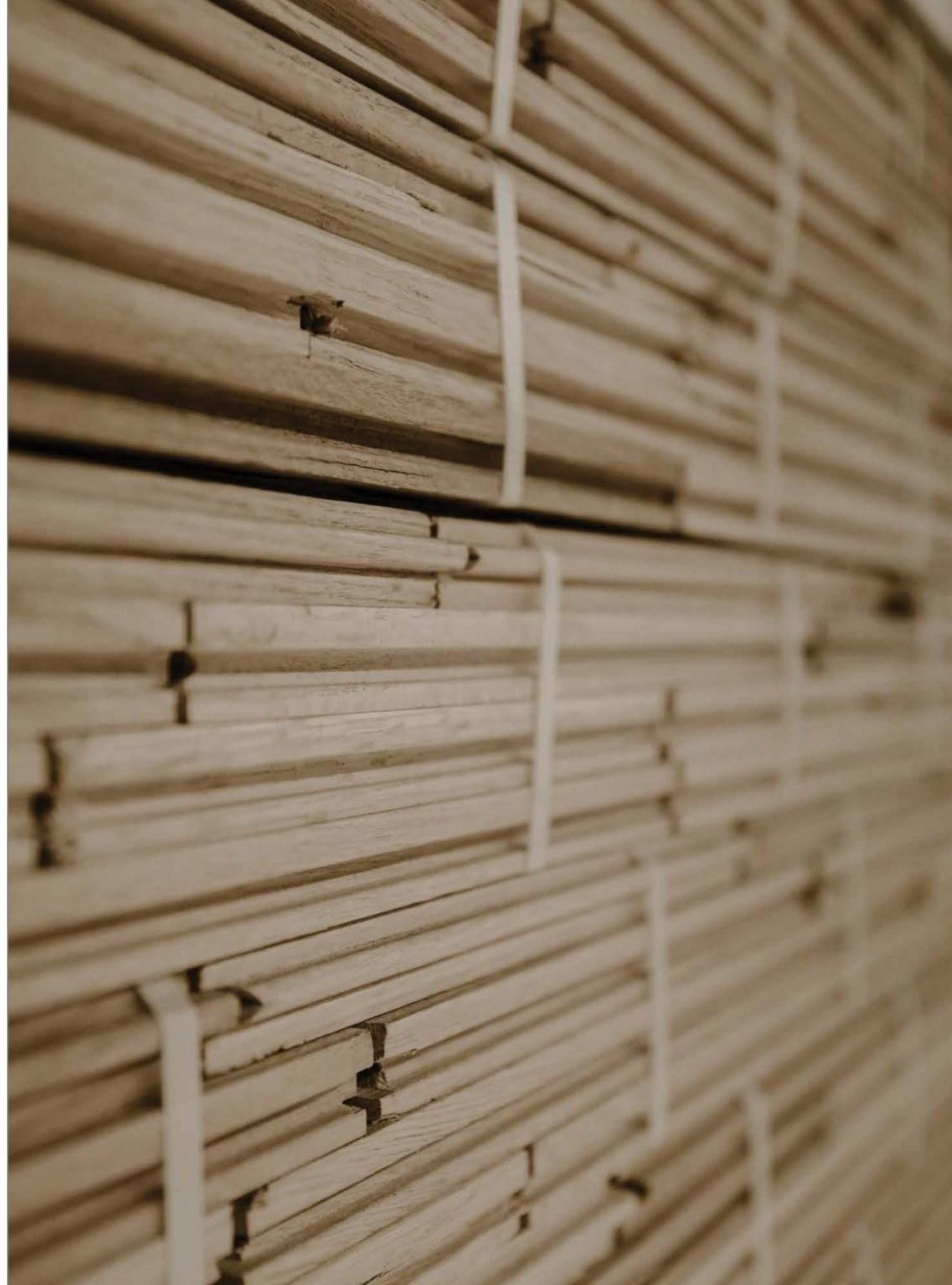



PRIME
White Oak (European)

RUSTIC
White Oak (European)

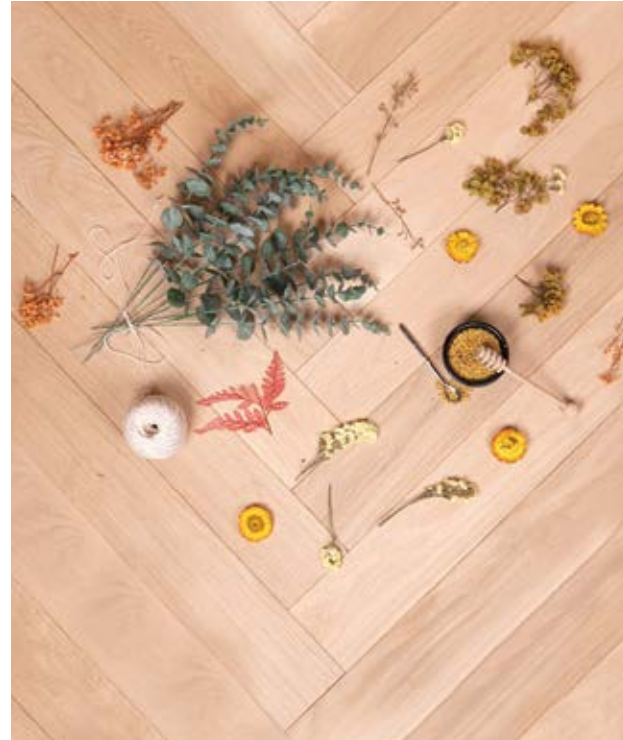

UNFINISHED RIFT AND QUARTERED
White Oak (American)

PRIME HERRINGBONE
White Oak (European)



WALNUT
Walnut



MAPLE
Maple



WHITE OAK
White Oak



RED OAK
American Red Oak



RED OAK
American Red Oak



UNFINISHED WENGE
Wenge

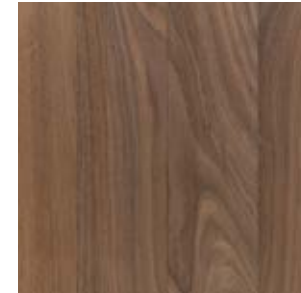

BRISTOL
SKU: XXWP301
American Walnut



STAMFORD
SKU: XXWP101
White Oak (North American)

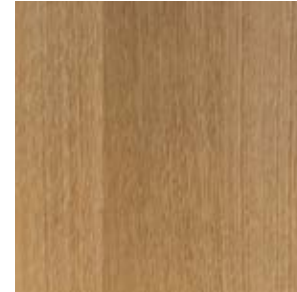

DANBURY
SKU: XXWR201
American Walnut



SHELTON
SKU: XXWQ401
White Oak (North American)



WHITE OAK, RIFT ONLY
SKU: HSG02
White Oak (North American)



WHITE OAK, QUARTERED
SKU: HSG03
White Oak (North American)

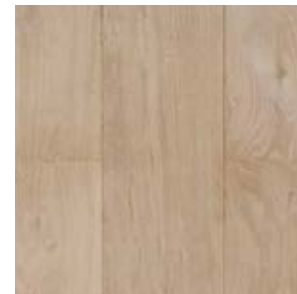

WHITE OAK, SELECT
SKU: HSG05
White Oak (North American)

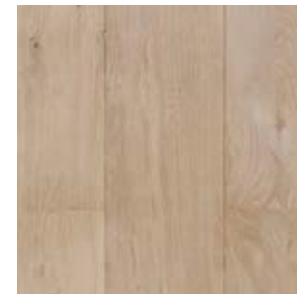

WHITE OAK, R&Q
SKU: HSG04
White Oak (North American)



WHITE OAK, CHARACTER R&Q
SKU: HSG01
White Oak (North American)



WHITE OAK, CHARACTER
SKU: HSG06
White Oak (North American)



OLD WORLD

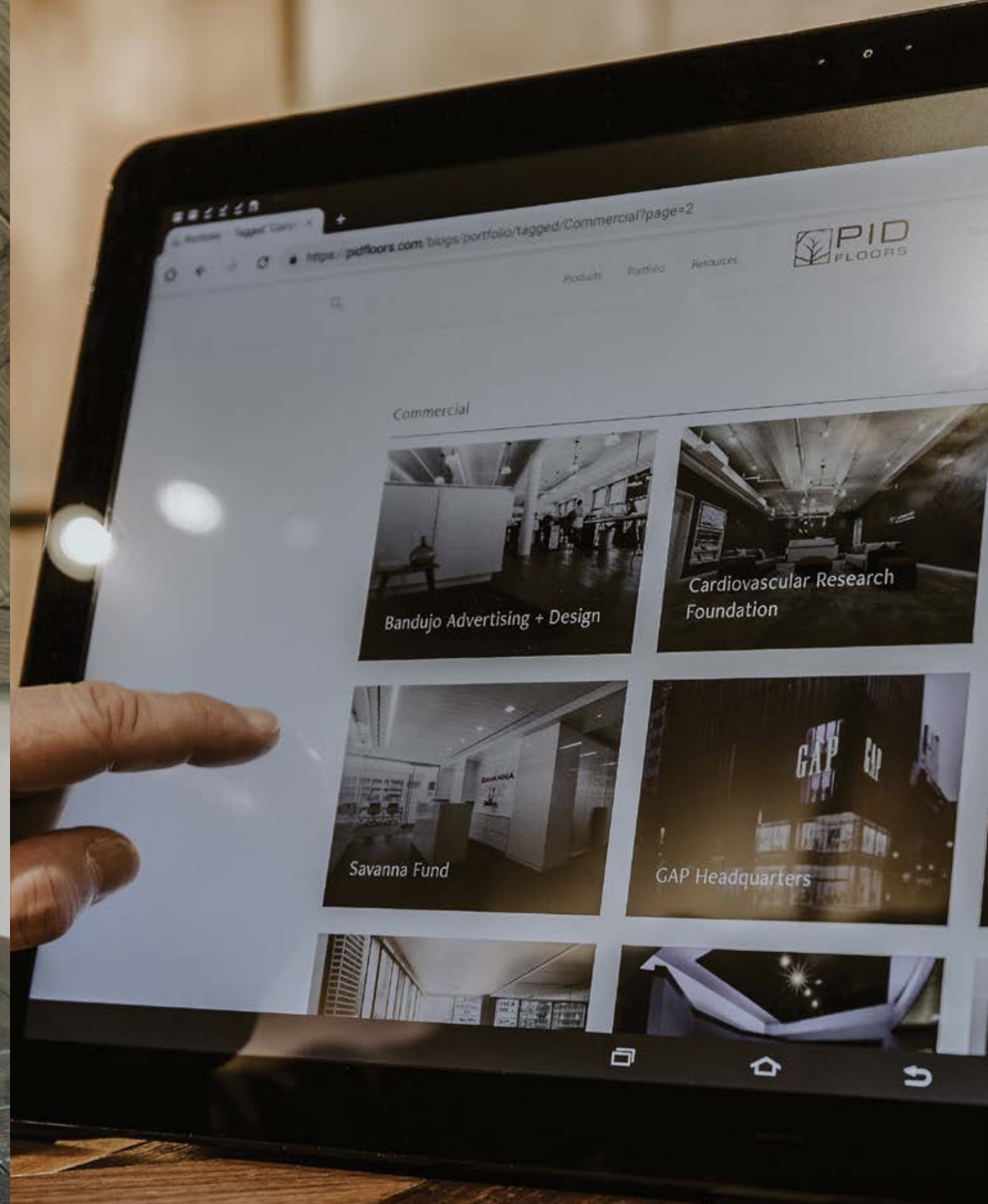

NEW WORLD

Featured In



Contact Us

We invite you to call, email, or visit us at one of our showrooms. Find us online at pidfloors.com.

FLAGSHIP

37 W 20th St
New York, NY 10011
212.337.3433
flagship@pidfloors.com

CORPORATE HEADQUARTERS

27 W 20th St, Suite 1004
New York, NY 10022
212.255.5028

BOSTON SHOWROOM

500 Harrison Ave., Suite 106
Boston, MA 02118
617.737.1898
boston@pidfloors.com

MIAMI SHOWROOM

6665 Biscayne Blvd,
Miami, FL 33138
305.960.7863
miami@pidfloors.com

DALLAS MARKET CENTER

Space # GL78 & GL79
2000 N Stemmons Freeway
Dallas, TX 75207
214.744.7441
dallas@pidfloors.com

PRO SHOP & DISTRIBUTION CENTER

1930 47th St
Brooklyn, NY 11204
718.972.9757
distribution@pidfloors.com

DISTRIBUTION CENTER | NEW JERSEY

1020 Oak St
Roselle, NJ 07203
212.337.3433
distribution@pidfloors.com

EMAIL US

info@pidfloors.com

sales@pidfloors.com

press@pidfloors.com

tradeprogram@pidfloors.com

international@pidfloors.com

FOLLOW US

Instagram: [@pidfloors](https://www.instagram.com/pidfloors)

LinkedIn: [@PID_Floors](https://www.linkedin.com/company/PID_Floors)

Facebook: [@PIDFloors](https://www.facebook.com/PIDFloors)



Flagship



D&D Building



Boston Showroom



Pro Shop & Distribution Center, Brooklyn, New York



Miami



Distribution Center, Roselle, New Jersey



Mylo the PID Floors Mascot

A FRIENDLY REMINDER FROM PID FLOORS AND THE NWFA

Wood flooring will perform best when the interior environment is controlled to stay within a Relative Humidity range of 30-50% and a Temperature range 60-80° F. During the winter heating season, Relative Humidity levels plummet and extra care must be taken to maintain an adequate environment for your wood flooring to perform optimally, i.e. without failure. Nearly every wood floor will have some seasonal separation between the individual boards – this is normal. However, excessive shrinkage from low RH levels can cause more serious, irreparable issues like cracking, cupping, delamination, and even buckling. This can be prevented by using a humidifier during the cold winter months.

