



Price: \$30

ORNAMENTAL FLOORS

DESIGN & INSTALLATION

Technical Publication No. B300
© 2015 | 3rd Edition

nwfa
National Wood
Flooring Association



111 Chesterfield Industrial Boulevard, Chesterfield, Missouri 63005
[P] 800.422.4556 [F] 636.519.9664 [W] www.nwfa.org

ORNAMENTAL FLOORS

DESIGN & INSTALLATION

2

INTRODUCTION

Design considerations

3

DESIGN AND LAYOUT

Common guidelines

Light

Selecting materials

Parquet patterns

Choosing borders

Ordering materials

Dry-laying the border

Measure twice, cut once

Laying out working lines

Perimeter working lines

Parallel layout

The trammel point method

The 3-4-5 method (Pythagorean Theorem)

Using a laser to determine working lines

The trammel point method for diagonal layout

Diagonal layout

Extending working lines to other rooms

10

INSTALLING ORNAMENTAL FLOORS

Importance of subfloor flatness

Installation methods

Installing the field

Building up the subfloor

Installing the border

Parquet installation

Herringbone installation

15

INSTALLING INLAYS

Manufactured inlays

17

INSTALLING MIXED MEDIA

Installing metal, stone, glass and leather

Care with metal and stone

Installing brass, copper and aluminum

Installing stone inlays

20

SANDING AND FINISHING

Have a game plan

Charge appropriately

Safety first!

Sanding ornamental floors

Varying grain direction, hardness and density

Sanding metals

Stone inlays

Finishing ornamental floors

23

HAND-SCRAPING AND DISTRESSING

Hand-scraping and distressing techniques

25

PAINTING AND STENCILING

Preparing the floor

Tape method

Self-adhering stencil method

Exotic species technique

Marbling & stone technique

28

SPECIALTY INSTALLATIONS

Bending wood

Making and using eccentric cams

Making and using wedges

Making and using a sliver template

Installing slivers

Building stairs

Procedure for building stairs

Enhancing existing floors

Being creative with factory-finished flooring

37

SOURCES AND CREDITS

NO GUARANTEE OR WARRANTY

The information contained in this publication represents widely accepted industry practices. There are, however, no universally approved methods of troubleshooting wood floors. The National Wood Flooring Association accepts no risk or liability for application of the information contained in this publication.

INTRODUCTION

THIS PUBLICATION IS INTENDED to provide an overview on ornamental floors, and also offer basic techniques required to produce such a floor. To take it to the next step, seek out craftsmen who are skilled at these techniques. The National Wood Flooring Association offers training schools, many of which offer instruction in advanced flooring installation techniques, led by veteran craftsmen.

For more information on dates, locations and curricula for upcoming NWFA schools, or for information on entering the annual NWFA Wood Floor of the Year contest, contact:

National Wood Flooring Association
111 Chesterfield Industrial Blvd.
Chesterfield, MO 63005
(800) 422-4556 (U.S.)
(800) 848-8824 (Canada)
(636) 519-9663 (local and int'l)
info@nwfa.org
www.nwfa.org

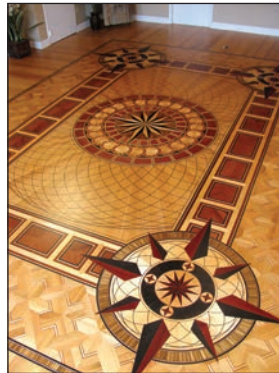

Design considerations

The key to a successful installation is communication between the wood flooring contractor and the client to ensure that all the elements of the floor design meet the client's preferences. When choosing the placement of borders, medallions and other flooring elements, pay attention to visual focal points in the room, including fireplaces, doors and ceiling designs. Furniture placement may also dictate the layout.

- Prepare a sample to test for compatibility of the stain and finish with the wood species and also to obtain the client's approval of the stain and finish appearance.
- Ensure that materials and job-site conditions are appropriate for installation. For guidelines on job-site conditions, grade levels, subfloors and acclimation, refer to the NWFA publication *Installation Guidelines*.



DESIGN AND LAYOUT



A SUCCESSFUL FLOORING INSTALLATION starts by consulting with the client to determine the optimum placement of the flooring pattern.

Common guidelines

- Adjusting the apron may minimize the need to make adjustment cuts on the pattern of the field. If cutting adjustments are necessary in the field, end with equal cuts on four sides if possible. If opposing walls are not parallel, place the field where it allows for half of the cutting adjustment on each side, so the field is centered.
- When calculating the layout, allow for expansion space at the room perimeter and at all vertical obstructions.

Light

Samples should be observed in the lighting environment in which they will be installed. Make clients aware that some species change color after prolonged exposure to light. (For more detailed information, see *Wood Species Used in Wood Flooring, NWFA Technical Publication No. A200*. To order copies, contact NWFA

at the address and phone numbers listed on the back page of this publication.)

Selecting materials

- Different species of wood have different rates of expansion and contraction. As a rule, the larger the piece of wood, especially in width across the grain, the more potential there is for movement. Parquet patterns usually run in at least two directions, which greatly lessens movement of the floor, since the wood is expanding and contracting in two or more directions.
- Different species of wood can vary greatly in hardness and other characteristics, with softer wood showing wear more than harder wood. Different species of wood also respond to sanding and finishing differently. Make the client aware—preferably in writing—of the effects of using different species.
- When using wood from different mills, be certain that the wood will fit together properly, or be prepared to re-cut grooves and use a slip-tongue or spline.

(See *Wood Species Used in Wood Flooring, NWFA Technical Publication No. A200*.)

Illustration A: Elements of a Hardwood Floor.

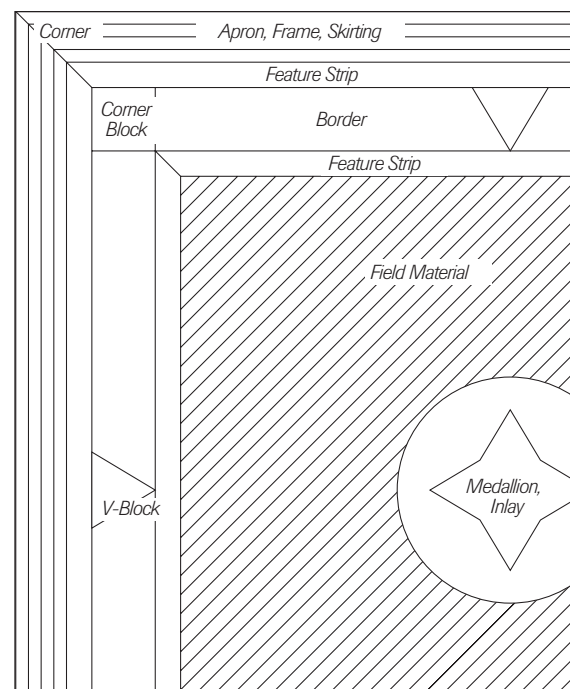

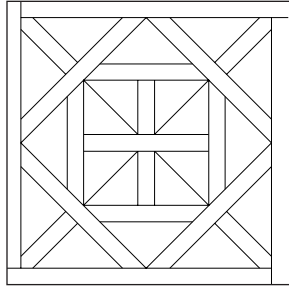

Bordeaux

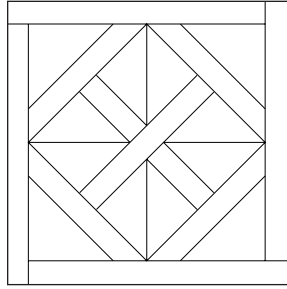

Brittany

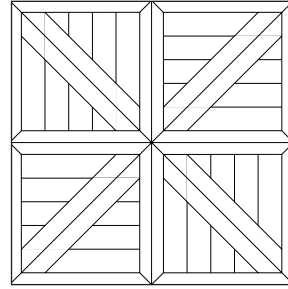

Canterbury

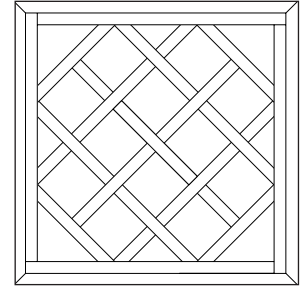

Fontainebleau

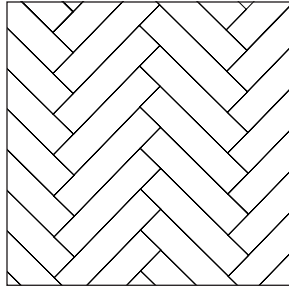

Herringbone

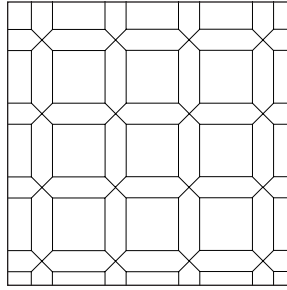

Jeffersonian

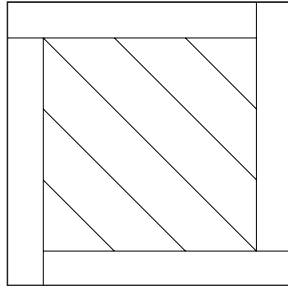

Louvre

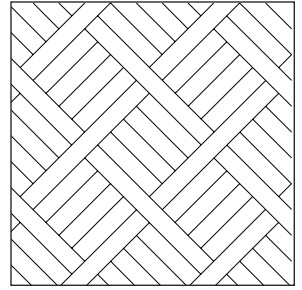

Marie Antoinette

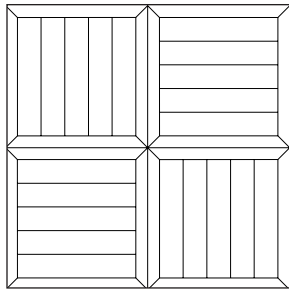

Monticello

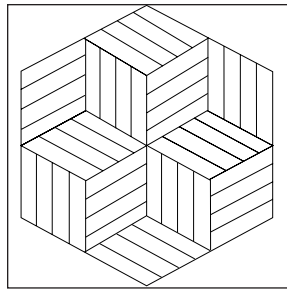

Rhomb

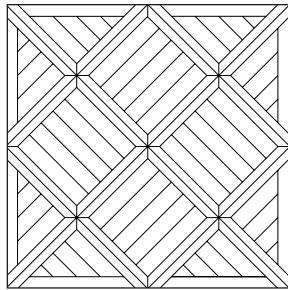

Saxony

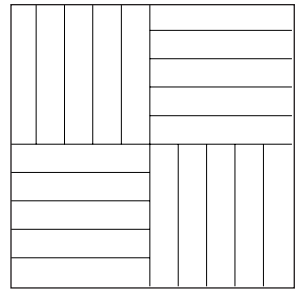

Standard Pattern

Corner Types for Aprons

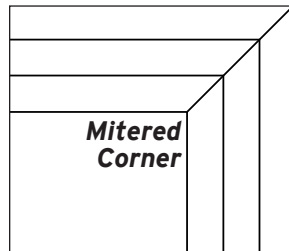

Mitered Corner

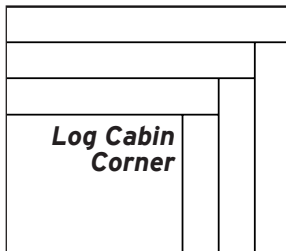

Log Cabin Corner

Corner Types with Parallel Apron

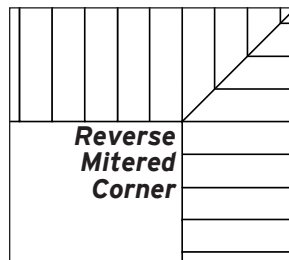

Reverse Mitered Corner

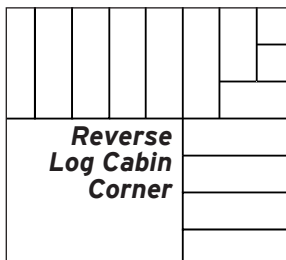

Reverse Log Cabin Corner

Corner Types with Perpendicular Apron

Corner Types for Borders

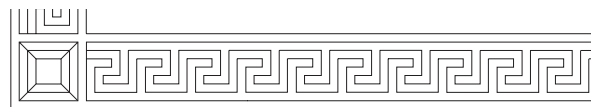

Greek Key border with a corner block

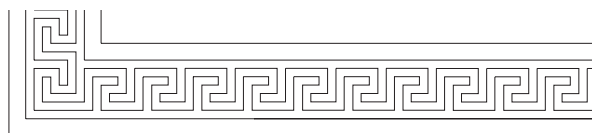

Greek Key border with a continuous corner

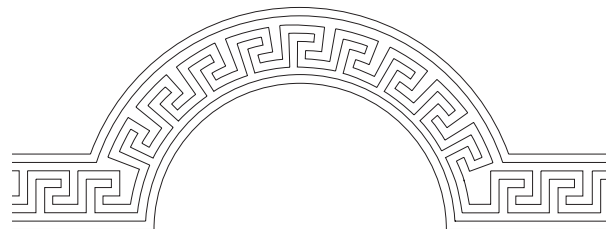

Greek Key border with a radius



Parquet patterns

Parquet patterns often take their names from famous people or places. The Monticello pattern, for example, is based on floors in Thomas Jefferson's home, and the Jeffersonian is a variation on that pattern. Others, such as Brittany, Bordeaux, Canterbury and Marseilles, are named for places where they are thought to have originated. There are also geometric patterns like herringbone, rhombs and standard pattern parquet. Custom parquet patterns also can be created, and end-grain blocks are sometimes classified in parquet patterns.

Parquet material thickness varies from $\frac{5}{16}$ " to $\frac{3}{4}$ " and may be solid or engineered. They are typically made up of individual pickets, assembled into panels held together by wire, mesh, tape or paperface (on the surface). Check with the manufacturers for specific installation instructions.



Choosing borders

- The border's width should suit the scale of the room. A 12-inch border might not be proportionate in a hallway, but it can often be reduced in scale.
- Borders are typically placed 12 inches or more from the wall. The apron, which is installed between the border and walls, can be used to adjust the dimensions of the pattern to fit the room. Cuts are made along the outer perimeter, and should be roughly equal on all sides of the room, so the apron is a consistent width. The apron can be laid either parallel or perpendicular to the border and can be either lapped or mitered at the corners.
- It's generally best not to border a complex parquet pattern with a complicated border design.
- A border should contrast the field. There are many contrasting wood species from which to choose.
- It is common to use the natural colors of species rather than relying on stain, thereby avoiding a dilemma the next time the floor is sanded.
- Some species are not compatible with others due to differences in expansion, bleeding of color and grain texture. Manufacturers and distributors can advise on the compatibility of wood species.

Ordering materials

- Check actual dimensions of the materials. Stated dimensions may be nominal, rather than actual.
- When ordering medallions, borders or feature strips, verify that the actual thickness of the medallion, border or feature strip will match the thickness of the flooring. (See "Installing Inlays" on page 15.)
- When estimating stone, consider the thickness of the material. A manufactured pattern may already have the backing necessary to ensure that the stone is flush with the floor surface. When creating a custom pattern, ensure the stone will be flush with the surface. (See "Installing Mixed Media" on page 17.)
- Most borders come in sections. When ordering, allow a cutting allowance, typically at least one extra section.
- Field dimensions should work out so that the outside edges of the field and apron finish with half or whole repetitions of the pattern.



Dry-laying the border

- Dry-lay the border around the room, noting how the border approaches the corner blocks. Most borders are designed to be cut at the corner block no matter where the pattern falls.
- Some borders have “continual flow” (or integrated) corner blocks that allow the border to continue with no interruption in pattern. Continual-flow corners require adjusting the pattern in the middle of the border with a V-block to allow the corner to accept the end of a repeated section properly.
- Some border patterns may require “right-hand” and “left-hand” sections in order to flow properly.
- In most cases, it is possible to adjust the field flooring to fit the border layout, or a feature strip may also be added. However, adjustments to the field must also be made so that the end result is aesthetically pleasing.

Measure twice, cut once

Make sure all measurements are accurate. Measure the space needed for the border and dry lay the border before installing the field. However, a dry layout should never be used for precise measurement purposes. Continue to take measurements and adjust throughout installation.

Laying out working lines

Working lines are guidelines drawn or marked with chalk on the subfloor. Some are critical measurements, such as the primary or secondary lines, while others can be placed as guides to stop nailing or spreading adhesive or to aid in layout of the different parts of the floor. Outlining an inlay on the subfloor can also be helpful.

- Working lines should be identified on the subfloor by using different colors or labeling them to avoid confusion between lines.
- To prevent working lines from being erased, apply a quick-dry spray lacquer over the lines.
- Mark your working lines on the subfloor and then transfer those lines to the moisture retarder.
- For working lines that connect to a wall, make a mark on the wall to indicate the line’s location in the event that the working line on the subfloor is covered during installation.
- After determining where the border will be located, snap a chalk line to indicate where the field will end and the border will begin.
- Actual layout and installation should begin with a center layout and installing the field first, working out toward the border.
- Working lines for installing the field will be determined by the layout chosen.



Perimeter working lines

- Establish working lines at the perimeter of the room, which will represent the estimated inside working lines of the border.
- Perimeter working lines should be equal to a multiple of the width of the materials being installed, and should be equidistant from their adjacent walls. These lines should be adjusted to fit the width and the aesthetics of the border design. If the number of pattern repeats in the field is uneven, adjust the center working line so that the pattern is even on each side of the room.
- Using a chalk line, snap parallel lines representing the inside of the border.
- Working from the center of the room, build the field of the floor toward the perimeter working lines. Periodically check the measurements and make adjustments to ensure that the field will meet the perimeter working lines without the need for unsightly cuts or rips.

Parallel layout

For parallel layouts, begin with 90-degree working lines at the center of the room. There are several methods for doing this, including the trammel point method (preferred), the 3-4-5 method, and the laser method.

The trammel point method (preferred method)

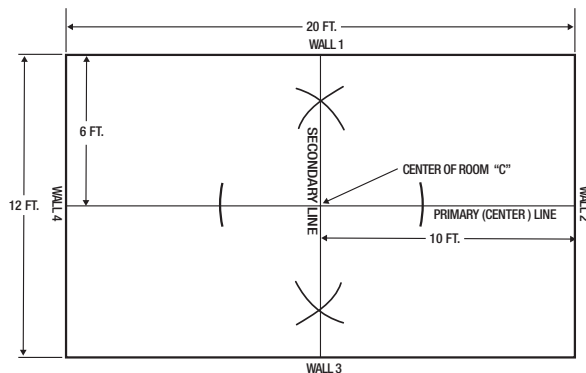
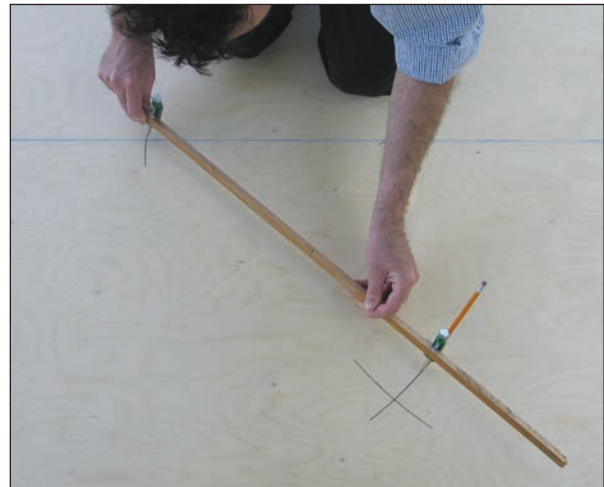

Diagram 1

- The Secondary Line must be exactly 90 degrees to the Primary Line. The directions below describe using trammel points and measurements of 3, 4 and 5 feet in a room measuring 12 by 20 feet. However, larger rooms may require doubling, tripling or even quadrupling those dimensions.

To determine the Primary Line

- 1) Measure Wall 2 to find the center point, and mark that point on the subfloor and wall.
- 2) Measure Wall 4 to find the center point, and mark that point on the subfloor and wall.
- 3) Snap a chalk line between those two points. This represents the Primary (center) working line.



To determine the Secondary Line

- 1) Measure to find the center point on the Primary working line. Mark that point C.
- 2) Using a 6-foot trammel point beam or bar compass set at 4 feet, scribe arcs on the Primary working line to the right and left of center point C.
- 3) From the points at which the arcs intersect with the Primary working line, adjust the trammel point beam or bar compass to 5 feet and scribe arcs in the general area of where the 90-degree Secondary Line will be. Do this both above and below the Primary working line.
- 4) Snap a line between the points where the arcs intersect, extending the line from Wall 1 to Wall 3. Also make a mark on each wall where the Secondary Line meets the walls. This line will be the Secondary working line and should be at a 90-degree angle to the Primary working line.
- 5) Verify all measurements using the 3-4-5 method before proceeding.

The 3-4-5 method (Pythagorean Theorem)

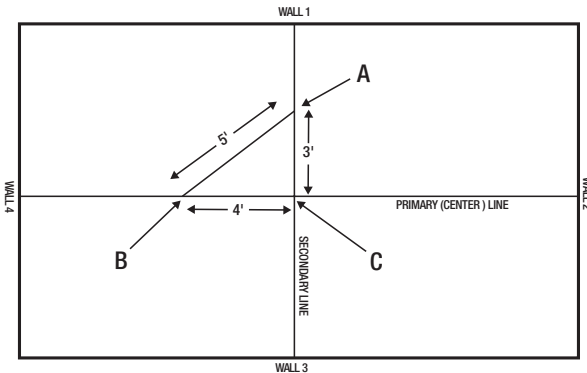

Diagram 2

- The Secondary Line must be exactly 90 degrees to the Primary Line. The directions below describe using measurements of 3, 4 and 5 feet. However, larger rooms may require doubling, tripling or even quadrupling those dimensions.

To determine the Primary Line:

- Measure Wall 2 to find the center point, and mark that point on the subfloor and wall.
- Measure Wall 4 to find the center point, and mark that point on the subfloor and wall.
- Snap a chalk line between those two points. This represents the Primary (center) working line.

To determine the Secondary Line

- Measure to find the center point on the Primary working line. Mark that point C.
- From the center point C, measure 4 feet along the Primary Line and mark that point B.
- From the same center point, measure 3 feet in the general direction of where the Secondary Line will be and scribe an arc.
- Return to the original 4-foot mark (point B) on the Primary Line and measure 5 feet, scribing an arc that crosses the 3-foot arc made in the previous step. Mark that point A.
- Verify all measurements before proceeding.
- Snap a chalk line through the conjunction of the two arcs (point A) and the center point (point C) of the Primary Line. This will be the Secondary Line.

Using a laser to determine working lines

Today's laser layout tools can assist in accuracy and speed in floor layout. Most laser layout tools have a primary beam line and a perpendicular beam, and often incorporate a 45-degree beam, as well.

More advanced lasers also have lights to align floor layout to tray ceilings, chandeliers and other features above the floor. Follow the manufacturers' directions and cautions on the use of any laser. General rules for using a laser layout tool are to:

- Mark the center of Walls 2 and 4 at the base.
- Align the laser to target both marks.
- Turn on the perpendicular lines and/or 45-degree lines.
- Mark lines accordingly and snap chalk lines.
 - Not all lasers can establish diagonal lines. To establish a diagonal working line, trammel points or the method described in the following section, "Diagonal layout," can be used.

The trammel point method for diagonal layout

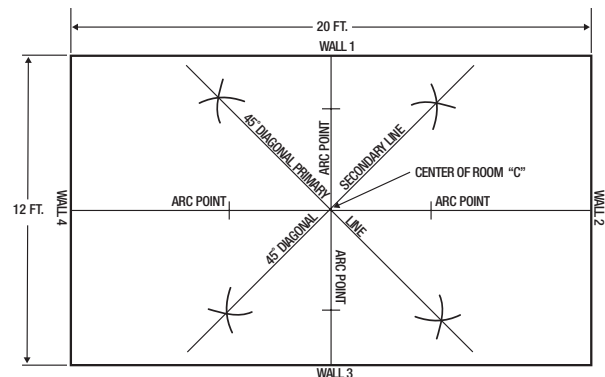

Diagram 3

- Using the Primary and Secondary Lines previously established, set the trammel point beam or bar compass at 4 feet and scribe arcs on the Primary and Secondary Lines on both sides of the center point of the room (C).
- Extend the trammel point beam or bar compass to 5 feet. Starting from the arc points on the Primary and Secondary Lines, scribe arcs in the approximate areas where the 45-degree working line will be located.
- Snap lines between the points where the arcs intersect, extending from Wall 1 to Wall 3, and also make marks on the walls where the lines meet the walls.
- These lines will represent the diagonal working lines and should be at a 45-degree angle to the Primary and Secondary working lines.
- Verify all measurements before proceeding.

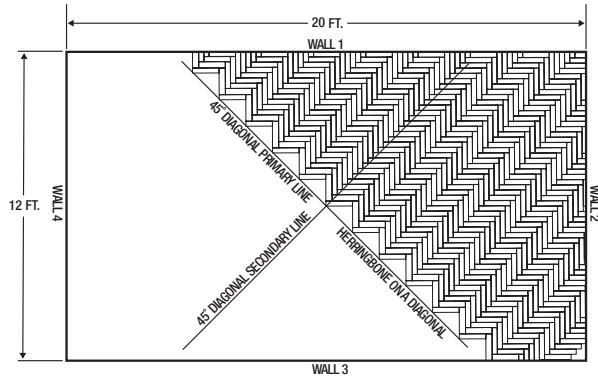

Diagram 4

- Diagram 4 illustrates an example of how diagonal working lines might be used to install a herringbone pattern. These diagonal working lines may be sufficient for laying herringbone units or other manufactured parquet patterns on a diagonal. However, additional working lines must be used when installing herringbone in a slat-by-slat method. (See "Herringbone layout" on pages 13-14.)

Diagonal layout

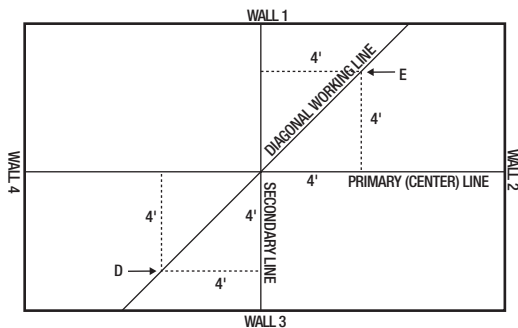

Diagram 5

For diagonal layout, start with a diagonal working line in the center of the room. (Herringbone installation requires a different working line. See "Herringbone Layout" on pages 13-14.)

- The Diagonal line must be at exactly a 45-degree angle to the Primary and Secondary Lines to form working lines for diagonal layout (See Diagram 5). To ensure this angle, do the following:
 - 1) From the center point, measure 4 feet down in each direction on the Primary and Secondary Lines.
 - 2) From each of these points, measure 4 feet and scribe an arc. The conjunction of these arcs creates points D and E.
 - 3) Snap a chalk line between points D and E, and the center point. This line represents a 45-degree angle.

Extending working lines to other rooms

Diagrams 6 and 7 illustrate how Primary and Secondary Lines in one room can be extended to hallways and other rooms to maintain consistent layout. In Diagram 6, for example, an additional Secondary Line is established from the Primary working line in the dining room, to extend into the hallway. A new Primary working line can then be established from that line, extending into the kitchen. Once any line is established, additional 90-degree and 45-degree working lines can be created, using the 3-4-5, laser or trammel point methods.

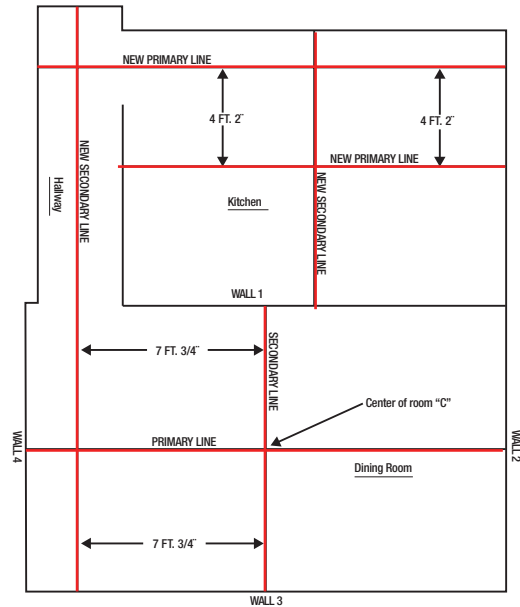

Diagram 6

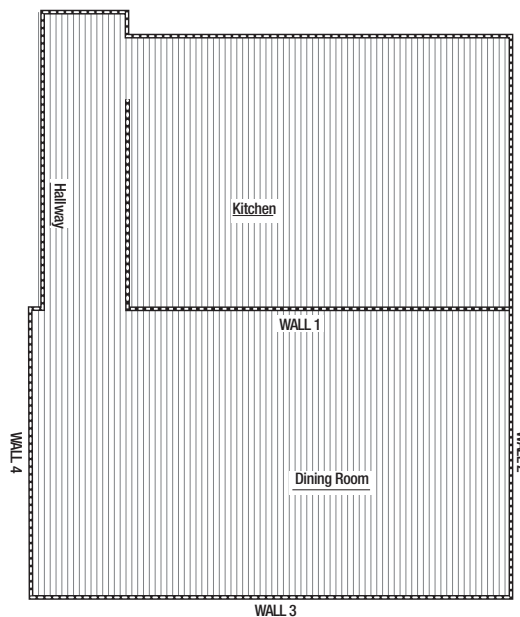

Diagram 7

INSTALLING ORNAMENTAL FLOORS



Before you begin installing, ensure that materials and job-site conditions are appropriate for installation. For guidelines on job-site conditions, grade levels, subfloors and acclimation, refer to the NWFA publication *Installation Guidelines*.

Importance of subfloor flatness

Subfloor flatness is critical in flooring installations that include borders, inlays and flooring patterns. Any irregularity in the subfloor will be mirrored in the finished floor.

Wood Subfloors: NWFA's *Installation Guidelines* specify that wood subfloors must be flat, clean, dry, structurally sound, free of squeaks and free of protruding fasteners. For installations using mechanical fasteners of 1½ inches and longer, the subfloor should be flat to within ¼ inch in 10 feet or ⅜ inch in 6 feet. For glue-down installations and installations using mechanical fasteners of less than 1½ inches, the subfloor should be flat to within ⅜ inch in 10 feet or ⅛ inch in 6 feet. Some manufacturers of herringbone slats specify that the subfloor should be flat to within ⅛ inch over 10 feet. If peaks or valleys in the subfloor exceed the tolerances specified, sand down the high spots and/or fill the low spots with a leveling compound or other material approved for use under wood flooring.

Concrete Subfloors: NWFA's *Installation Guidelines* specify that a concrete slab should be flat to the wood flooring manufacturer's specification. Typically, manufacturers will specify a flatness tolerance of ⅛

inch to ⅜ inch in a 10-foot radius. If the slab is out of specification, high spots can be removed by grinding and depressions can be filled with approved patching compounds. Slabs also can be flattened using a self-leveling concrete product specified for wood flooring. When sanding or grinding concrete, minimize the amount of silica dust produced. Follow OSHA safety recommendations for dust collection and use of approved respiratory and eye protection.

Installation methods

- Follow installation instructions provided by the product manufacturer and, in the case of a glue-down product, the adhesive manufacturer.
- Follow the flooring manufacturer's guidelines for expansion space. A general rule is that a minimum expansion space of ½ inch for engineered wood flooring and ¾ inch for solid wood flooring must be left around the perimeter and vertical obstructions.
- Measure the room to see if walls are parallel and if the corners are square. If they are not, make adjustments. In the case of a patterned floor, it may be best to make the adjustments within the apron, ensuring equal cuts on all sides.

Installing the field

- Install the flooring from the center of the room outward, beginning at the working line. To establish a working line, follow the steps in "Design and Layout" on page 3.



- Install a minimum of three rows against a straight-edge, starter board or backer board attached to the floor along the working line.



- A slip-tongue (spline) is used to reverse the direction of tongue-and-groove flooring. After a minimum of three rows have been installed, remove the straight-edge and, in the exposed groove of the first row, attach the slip-tongue with glue, plus fasteners, 8 to 10 inches apart.
- Install past the working line of the field (in glue-down applications, do not spread adhesive past the border working line). Do not place fasteners within ½ inch of this working line, to prevent damage to power tools when completing the following step.



- Resquare your field and cut the field flooring back to the border working line. Use a straight-edge as a guide to cut the ends of the field flooring along the border line.



- When installing prefinished product, the surface should be protected from scratches by applying tape or another protective surface on the face of the base plate of the cutting tool. Cutting prefinished products may require easy-release tape along the cutting line to protect the surface, prevent chipping and to eliminate edge burring.



- Prior to installing the border, cut a groove for a slip-tongue or spline where necessary, using a router bit designed for the thickness of flooring.

Building up the subfloor

- When using flooring of different thicknesses for the field and border, the subfloor must be built up beneath the thinner material using plywood, OSB or other approved subfloor materials. When installing a stone border of a different thickness than the field flooring, use cementitious board, dry pack or slurry.
- Using urethane construction adhesive and screws, glue and screw the substrate material to the floor. Allow for expansion space of the substrate material. Do not butt the substrate material tightly against the adjoining material.

Installing the border

- Starting with the corner blocks, dry-lay the border and determine the most aesthetic location to make any necessary cuts. Ensure proper orientation of the corner blocks.



- Following the border manufacturer's instructions, spread the approved adhesive onto the subfloor. Use the trowel size and profile recommended by the adhesive manufacturer and heed the flash-time and open-time directions.



- Install the corner blocks and border.



- Tongue-and-groove borders can be blind-nailed along with the field. Where the border runs parallel to the field, the border can be blind-nailed in the same direction as the field. Where the border runs perpendicular to the field, rout a groove in the ends of the field boards, then insert a slip-tongue. The groove side of the border can then be installed against the slip-tongue and the border can be blind-nailed.
- To install the apron, start with the grooved ends of the flooring and interlock them with the tongue sides of the border.
- Most borders repeat the interior pattern design at intervals. This is important when departing from a continuous corner block. To maintain continuity, calculate the linear runs of the border in appropriate intervals.
- When installing wood in adhesive in a mixed-media installation, lay out and snap lines for both sides of the wood for the entire job. Spreading the adhesive within those lines eliminates the need to scrape adhesive from areas of the subfloor that might require other types of adhesives.



Parquet installation

- Some 3/4-inch parquet is appropriate for nail-down installation, although glue-down application is more common. Use the wood manufacturer's approved adhesive, and follow the spread rate, trowel size and installation procedure recommended by the adhesive manufacturer.
- Recommended installation procedures vary among manufacturers. Installation instructions are usually provided with the flooring or are available from the manufacturer or distributor.



Herringbone installation

Herringbone direction should be installed in accordance with client preference. The pattern may look best with the points in the direction of the longest dimension of the room, or toward a major focal point. Flatness of the subfloor is especially critical in herringbone installation, so ensure that the subfloor is flat to within specified tolerances – typically within 1/8 inch over 10 feet. (See "Importance of Subfloor Flatness" on page 10.

Laying out a herringbone pattern:

- Measure the room for center and strike the main control, perpendicular and diagonal reference lines.
- Measure for true center on the herringbone pattern to establish working lines.
- Strike two working lines alongside the main control line.
- Transfer the diagonal lines to the working lines.
- Dry lay a small section and measure to confirm a balanced layout.

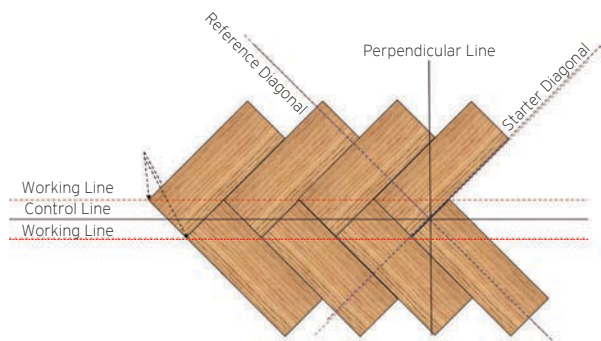

The herringbone floor pattern is installed along working lines.

Note the true center position of a herringbone pattern.

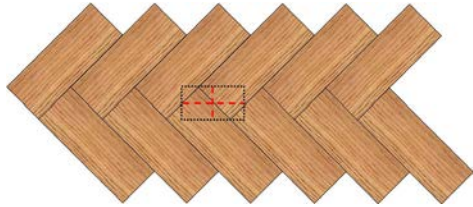

Layout procedure - Determining the diagonal dimension of the flooring.

Measure

1. Divide the diagonal measurement by four.
2. This is the dimension used to establish the working lines A and B on both sides of the control line.

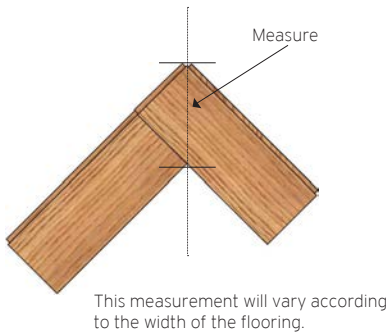

Once the working lines are established the installation can begin.

To keep the installation square, cut a square piece of plywood the size of the herringbone pattern and anchor it at the intersection of the working lines and diagonal lines.

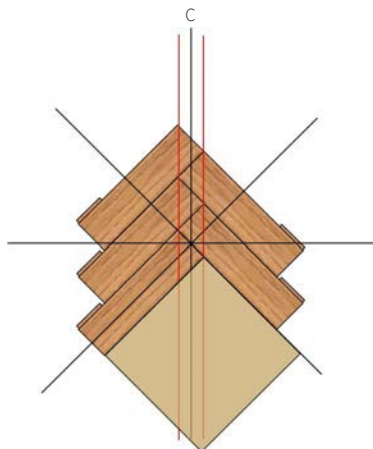

Installing a herringbone pattern:

- The starting point must have working lines and diagonal lines.
- For direct glue, do not spread adhesive over working lines.
- Start with the tongue towards the build direction.
- Install pattern one row at a time.
- Periodically check alignment.

To continue the pattern:

- Dry lay eight boards
- Lay a framing square from the points on the working line to the outermost point
- Record measurement A, this becomes your working line for the next course

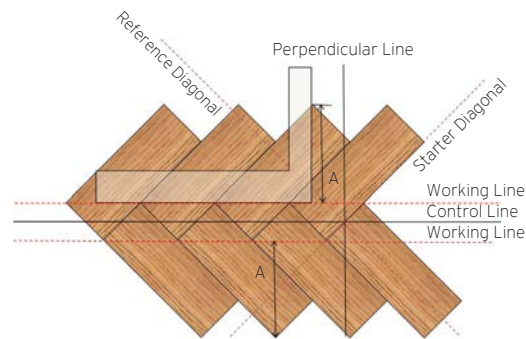

Once measurement A is established, the working lines can be repeated throughout the installation.

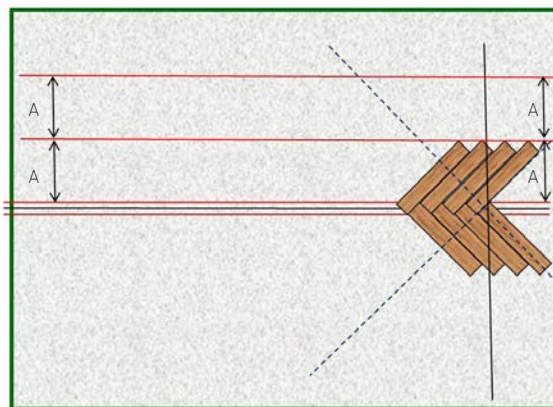

INSTALLING INLAYS



INLAYS CAN BE INSTALLED in conjunction with a new hardwood floor, or they can be used to enhance an existing floor (see page 35).

Manufactured inlays

While many flooring contractors create their own inlays, several manufacturers produce these products—usually with a template and pattern bit that can be used to cut the flooring to the proper size and shape. Many manufacturers also produce custom-designed inlays and matching borders.

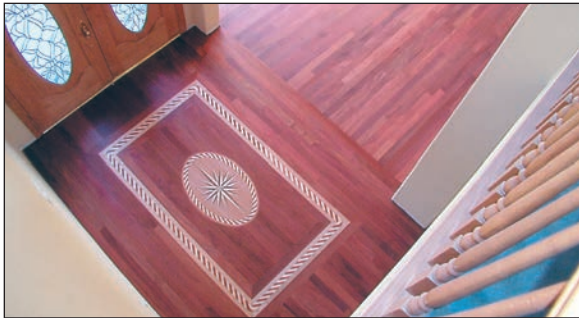

Installing manufactured inlays

- Always follow the inlay manufacturer's recommendations for installation. However, the following general guidelines can be useful.
- Before installation, check the product to ensure there are no missing parts or damage in shipping. If a shop drawing was required, compare the drawing to the inlay for accuracy in measurements, thickness and selection of species.
- Follow the inlay manufacturer's recommendations for acclimating the product prior to installation. If the product requires acclimation, the HVAC system needs to be operating, with temperature and humidity levels acceptable for normal living conditions.

- Position the inlay by taking into consideration the walls, vents, openings and furniture. Have the client approve and sign off on the position.
- Inlays should be installed after the floor is laid to ensure a proper fit into the floor.



- Installation can be started by placing the inlay on the floor and marking the outline with a pencil. Use magnets to find any fasteners along the outline and mark them. Most companies offer a template, thereby reducing the chance of making bad cuts outside the proposed area for the inlay. Pay attention to small pieces of the floor that may be on the edge of the cutout area.
- To assist in smoother routing, it may help to sand the adjacent area prior to routing.



- Fasten the template to the field flooring. The template can be fastened with double-sided tape, or by finish nailing into the field flooring between the floor boards.



- Using a plunge router and bit (see photo inset), cut away the existing flooring on the inside of the template in a clockwise direction, starting with a plunge depth of $\frac{1}{8}$ to $\frac{1}{4}$ inch. Ensure that the router bearing rides against the template. Rout in at least three to four passes at increasing depths to avoid overheating and damaging the router bit. Continue this process until the router reaches the subfloor.
- Denser wood species may require four or more passes.



- If you expose nails on any pass, use a nail set to drive the nail further into the floor and out of the way of the router bit.



- Use a sharp chisel or corner chisel to clean up areas, such as corners, not removed by the router

bit. Vacuum the subfloor to remove all debris.

- **IMPORTANT:** Install the inlay as soon as possible after routing the outline; delaying inlay installation may allow the field to close up around the outline.
- Dry fit the inlay to ensure proper fit. Make sure the inlay is flush with the floor surface. Use packaging tape or similar tape across the back of the inlay to create handles extending above the sides that can be used to lift the inlay out of the opening after dry fitting.
- Unfinished inlays often include knockouts (loose pieces), which can be removed to allow screwing the inlay to the subfloor. In this case, remove the knockouts before installing the inlay.



- Apply adhesive to the subfloor in a thickness that will match the overall elevation of the floor. Follow the inlay manufacturer's recommendations on proper adhesives.
- Install the inlay, weighting it to ensure a good fit, and let the inlay set up in the adhesive. Follow the adhesive manufacturer's recommendation for ventilation, application and drying time.
- If the inlay contains knockouts, screw the inlay to the subfloor in the knockout areas. The knockouts should be glued into place in the inlay.
- If there are gaps, use the sliver method described in "Specialty Installations" on page 32 or use a wood filler that will match the color of the wood species.

INSTALLING MIXED MEDIA

HARDWOOD FLOORING CAN BE enhanced by using many different types of mixed media. They range from metal to glass and even leather. This customization is something that takes many years of experience to perfect.



Leather



Glass

Installing metal, stone, glass and leather

Marble, granite, brass, copper, aluminum, glass and leather have properties that may require special attention, especially in the sanding process. It is not recommended to sand most stone inserts. Glass and leather should not be sanded, of course, and metals require special care in the sanding process. (See "Sanding and Finishing" on page 20.)

NOTE: Do not use ferrous metals such as steel and stainless steel because of the risk of sparks during the sanding process.

Nonferrous metals such as brass, copper and aluminum can be bent into many forms and routed into a floor. They can be built into a pattern off-site and laid as a prefinished floor, or they can be installed on-site. Most nonferrous metals can be polished, scraped, sanded and dulled with lye to achieve an antique patina. Brushing with a woven abrasive pad gives most metals a shiny but muted appearance.

Care with metal and stone

Wood, metal and stone will react differently to environmental conditions. Wood expands and contracts with humidity conditions, whereas stone and metal react only to temperature changes.



Granite

Installing brass, copper and aluminum

- Use both nails and epoxy to avoid having a metal inlay curl up during the sanding process.
- Use brass, copper or aluminum nails, depending on which metal is being installed. Generally, the nail should be the same metal as the inlay.
- Different adhesives may work better in some installations and in some parts of the country than others. Commonly used adhesives are two-part epoxy and moisture-cure urethane adhesive. Do a test installation and sanding to ensure that the adhesive will continue to bond the metal and the wood during sanding.
- It's preferable to use 1/4-inch-thick nonferrous metal.



- Precut and drill the metal at 9- to 10-inch intervals, using a drill bit the same diameter as the nails.
- Flatten the floor, taking off overwood and underwood, to ensure easier routing and a consistent depth with the router.
- To ensure that the adhesive will bond well with the metal and wood, clean the metal, using sandpaper and a solvent, such as lacquer thinner—but do it away from the floor.
- Mark the floor where the metal is to be installed. Use a straight-edge or template for the desired design fastened to the floor to guide the plunge router and bit.
- Use a bit the same width as the metal strip being installed.
- The metal, after installation, should be approximately 1/32 inch below the surface of the wood. This will allow sanding the wood down to the level of the metal and minimize overheating the metal. Keep in mind that the adhesive will raise the metal slightly.



- Apply adhesive into the channel. Do a section at a time, since most epoxies have only a five-minute working time. Place the metal into the channel and install nails into the predrilled holes before the adhesive cures.

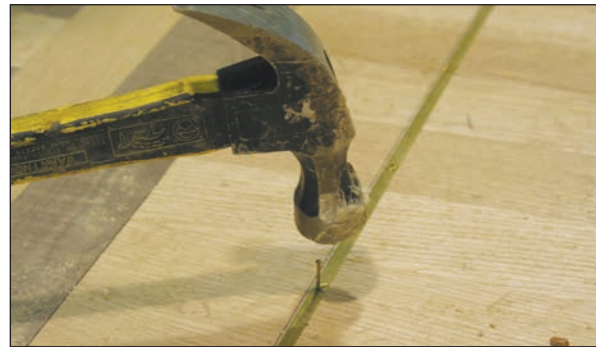

- The nail heads will be sanded off flush with the surface.



Aluminum

Installing stone inlays

Stone inlays should be installed before the final coat of finish is applied. For more information, see “Stone Inlays” on page 19.



- Always follow the inlay manufacturer's recommendations for installation. However, the following general guidelines can be useful.
- Before installation, check the product to ensure there are no missing parts or damage in shipping. If a shop drawing was required, compare the drawing to the inlay for accuracy in measurements, thickness and selection of species.
- Follow the inlay manufacturer's recommendations for acclimating the product prior to installation. If the product requires acclimation, the HVAC system needs to be operating, with temperature and humidity levels acceptable for normal living conditions.
- Position the inlay by taking into consideration the walls, vents, openings and furniture. Have the client approve and sign off on the position.
- Inlays should be installed after the floor is laid to ensure a proper fit into the floor.
- Installation can be started by placing the inlay on the floor and marking the outline with a pencil. Use magnets to find any fasteners along the outline and mark them. Most companies offer a template, thereby reducing the chance of making bad cuts outside the proposed area for the inlay. Pay attention to small pieces of the floor that may be on the edge of the cutout area.
- To assist in smoother routing, it may help to sand the adjacent area prior to routing.
- Fasten the template to the field flooring. The template can be fastened with double-sided tape, or by finish nailing into the field flooring between the floor boards.
- When routing for placement of a stone inlay, allowance must be made for a transition material such as silicone, latex or cork. Some manufacturers of stone inlays supply the stone and backing with

built-in transition material, with the template set to accommodate the transition material. If not, rout the hole wide enough to accommodate the transition—typically between $\frac{1}{8}$ and $\frac{1}{4}$ inch.

- Using a plunge router and bit, cut away the existing flooring on the inside of the template in a clockwise direction, starting with a plunge depth of $\frac{1}{8}$ to $\frac{1}{4}$ inch. Ensure that the router bearing rides against the template. Rout in at least three to four passes at increasing depths to avoid overheating and damaging the router bit. Continue this process until the router reaches the subfloor.
- Denser woods species may require four or more passes.
- If you expose nails on any pass, use a nail set to drive the nail further into the floor and out of the way of the router bit.
- Use a sharp chisel or corner chisel to clean up areas, such as corners, not removed by the router bit. Vacuum the subfloor to remove all debris.
- **IMPORTANT: Install the inlay as soon as possible after routing the outline; delaying inlay installation may allow the field to close up around the outline.**
- Dry-fit the inlay to ensure proper fit. Make sure the inlay is flush with the floor surface. Use packaging tape or similar tape across the back of the inlay to create handles extending above the sides that can be used to lift the inlay out of the opening after dry-fitting.
- Before sanding, remove the inlay and insert a plywood blank, or invert the inlay with the backing facing up (if this is done, protect the face of the inlay).
- The floor should then be sanded and finished (remove the inlay or blank before finishing).
- Apply the recommended adhesive to the subfloor in a thickness that will match the overall elevation of the floor. Follow the inlay manufacturer's recommendations on proper adhesives.
- Install the inlay, weight it to ensure a good fit, and let the inlay set up in the adhesive. Follow the adhesive manufacturer's recommendation for ventilation, application and drying time.

SANDING AND FINISHING



Have a game plan

THE FIRST CONSIDERATION TO a successful and profitable sand-and-finish job is your customer's expectation. It is always good practice to prepare a sample of how the stain and finish will look and obtain the client's approval before proceeding. Some species change color over time and the client should be informed of that. Also keep in mind:

- Many species accept stain differently from others and some exhibit compatibility problems with different finishes. Consult with the distributors and manufacturers of the specified woods, stains and finishes to ensure compatibility. For information on species color change, as well as compatibility of finishes with various species, refer to the *Wood Species Used in Wood Flooring, NWFA Technical Publication No. A200*. To order copies, contact NWFA at the address and phone numbers listed on the back page of this publication.)
- When dealing with a variety of species, media and grain directions, recognize that no two floors are alike and therefore no two floors should be sanded exactly the same way. Every floor needs to be looked at individually to determine the optimum method of sanding, without dishing out the grain

of the softer wood or introducing excessive scratch patterns caused by sanding across the grain. This includes looking for the main focal points of the room, light sources and doorways, etc.

- To maximize effectiveness, have a game plan in mind before beginning to sand the floor. Inspect the floor carefully on hands and knees to determine the dominant grain direction and where there is significant overwood and underwood. Examine the places where the field and border meet, and areas where mixed species and mixed media meet. Then decide:
- What type of sanding machine will work best in this environment? A big machine and edger? An edger first? An orbital, oscillating or multi-disc sander? A floor buffer and hard plate? Or some combination?
- What are the optimum directions for sanding the floor? Sanding across the grain may introduce excessive scratch patterns that may be difficult to remove in subsequent sanding cuts. When species of varying hardness and density are next to one another, there may be a tendency for the sander to cause dish-out in the softer woods.
- What grades of abrasive should be used? As many as needed to reduce the scratch from the previous cut. While the typical skip-a-grit progression used on a straight-lay floor may work on a patterned floor, there may be times when it will be necessary to use consecutive grits in order to remove the scratch pattern. Or it may be necessary to repeat the same grit in different directions to flatten the floor and remove the previous scratch.
- **CAUTION! Using different species of wood, as well as stone and metal, places materials of varying hardness and density next to each other. Different species and non-wood materials may react differently to sanding, stains and finishes.**

Charge appropriately

Remember that to achieve a successful ornamental floor, the job cannot be rushed. Time does not matter—results do.

For that reason, ensure that the amount charged for sanding an ornamental floor is adequate to cover the actual time required. Sanding an ornamental floor will take more time—often considerably more time and expertise—than sanding a straight-lay floor.

Safety first!

- Sanding dust is highly flammable. To minimize the risk, never operate the sanding machine when the bag is more than half full. Also, never leave the sanding machine with dust in the bag or any bag of dust in your vehicle, in your shop or on the job site.
- Use eye, ear and respiratory protection devices as required by OSHA. In particular, the sawdust from exotic woods can cause an adverse or allergic reaction in some people. Use approved respiratory protection when emptying dust bags or dust collection systems.
- Be sure you have safe electrical hookup.
- Have all machine guards and grounded plugs in place.
- Keep electrical cords away from the machines' moving parts. Also, keep cords out from underfoot and off your shoulders.
- Unplug all machines when you are repairing or adjusting them, or when changing abrasives.

Sanding ornamental floors

In addition to the following guidelines, the prerequisites for sanding any wood floor also apply. For information on sanding techniques, refer to the National Wood Flooring Association publication *Sand and Finish Guidelines*.

Varying grain direction, hardness and density

- Where wood grain does not run in the same direction, ensure that the abrasive does not create an uneven surface. A drum or belt sander cuts in only one direction and does not cut as aggressively with the grain as it does across the grain, causing dish-out in the cross-grain areas. Cutting across the grain is also likely to introduce more scratch patterns than is typical when sanding a straight-lay floor. Use the finest grade to achieve a flat floor. It is better to cut the floor in different directions with grade 50 twice than once with grade 36.
- To overcome this, cut at an angle to the floor in two directions. The angle chosen may be dictated by the variations in grain direction. Experience will suggest the optimum angle and direction of sanding. A third cut along the long dimension of the room taken in consideration of the room's focal points must also be made. Typically the next abrasive sequences use a buffer and hard plate, an orbital, oscillating or multi-disc sander to continue to refine the scratch pattern. Extra sanding may also be required using hand-held orbital sanders or by hand.
- Orbital, oscillating or multi-disc sanders tend to provide a less aggressive cut, and also a more

random abrasion pattern, thereby minimizing the dish-out effect in the soft-grain areas and reducing the scratch pattern that must be removed in subsequent cuts.

- Where grain pattern changes are limited to a small area—such as inlays, borders or inlays—avoid using a drum or belt sander. Sand these areas with an edger, then with a floor buffer and hard plate or an orbital, oscillating or multi-disc sander. Again, pay close attention to floor flatness and scratch refinement.
- Vacuuming between cuts is recommended.
- When sanding is completed, vacuum and tack extremely well. A close inspection, often with bright lights and on hands and knees, must be performed. Care and attention must be paid to focal points of the room and floor. Now is the time to make corrections prior to finishing.

Sanding metals

- **CAUTION: When sanding brass or other metals with a drum or belt sander, be aware that metal will dull the abrasive and create uneven sanding patterns in the wood.**
- When using an edger, be careful not to overheat the metal, which can burn the adjacent wood or cause metal expansion, which may lead to adhesive bond failure.
- If metal is protruding above the surface of adjacent wood, use a router with a pattern bit to cut the metal down to slightly below the surface of the wood floor. The other alternative is to sand the metal flush with an edger using 50- or 60-grit paper. However, it is generally better to have the metal slightly ($\frac{1}{32}$ inch) below the floor surface to minimize the heat generated when sanding the floor.
- When sanding metals, sand at short intervals and move to different areas, allowing the metal to cool.
- Vacuum metal filings from the floor surrounding the inlay and use a solvent such as lacquer thinner or denatured alcohol to clean the floor before applying finish. Always check the finish manufacturer's directions for compatible tacking solvents and finishes and take the necessary precautions when using solvents.

Stone inlays

- It is not recommended to sand stone inlays.
- A plywood blank can be inserted in place of the stone during the sanding phase. Secure the blank with countersunk screws. Once the sanding is completed, the blank can be removed.

- Some manufacturers supply stone inlays with a wood backing. In this case, the inlay can be put in place inverted, with the wood backing facing up, during the sanding phase, then reinserted with the stone up after sanding is completed. If this is done, protect the inlay's surface before inverting it. Dry-fit the inlay to ensure proper thickness and flatness to the floor. Additional sanding of the insert backing may be needed to compensate for adhesive thickness when gluing the insert.



Finishing ornamental floors

The next process is applying the protective coating to the ornamental floor. This includes a variety of finishes that stain, seal and protect the floor and the customer's investment. This critical process of the floor professional's time and effort requires extra detail to ensure a top-rate job.

In addition to the following guidelines, the prerequisites for finishing any wood floor also apply. For detailed information on finishing techniques, refer to the NWFPA publication *Sand and Finish Guidelines*.

- Have a game plan for starting and stopping finishing.
 - A professional finish comes from a clean job site. Extra care needs to be taken on the whole job site (not just the floor). Using walk-off mats or rugs and shoe covers, and carefully vacuuming and tacking the entire job site are among the things needed to ensure a clean final coat.
 - Always follow the manufacturer's directions regarding coverage, dry time and application procedures.
 - Check finish compatibility with all species.
 - Inspect the sanding job before applying finish.
 - Follow a procedure similar to the one used to make the sample.
 - Consider the primary light source—patio doors, large windows, etc.—when finishing.
- Ornamental floors typically have wood pieces oriented in multiple directions, which often makes it challenging for a streak-free application of the final coat. More and more finish manufacturers suggest using a roller for floors with multidirectional installations. Roller application allows applications across the grain pattern of wood floors without leaving the typical and pronounced streaking of the matting agent in the finish coat associated with a lineal applicators such as a T-bar, brush or lambswool. Check with the finish manufacturer for advice on potential roller application.
 - Because of the multidirectional pattern of an ornamental floor it is of utmost importance that the final finishing coat has enough time to flow and level. So, apply the finish rather fast but in a controlled fashion, and do not overwork it.
 - During application, avoid any direct airflow across the floor, and cover windows to prevent hot sunlight from warming up the floor too much.
 - To promote the best potential flow and leveling, it is important that the floor, air and finish are at the most ideal application temperature. Check with the manufacturer of the finish you plan to use. Generally speaking, a range of 65-80 degrees Fahrenheit is ideal. Cooler temperatures result in reduced flow and leveling, since all finishes tend to thicken when they are cold. Warmer temperatures will result in rapid evaporation of the solvents in the finish and may result in poor flow and leveling.
 - Inspect each coat of finish and fix any problems before proceeding with the next coat. Abrade the finish per the manufacturer's directions, and vacuum and tack the floor between every coat.
 - Fully inform the customer of the maintenance and how to properly care for the floor on a daily/weekly basis.

HAND-SCRAPING AND DISTRESSING

Most contractors who have become adept at distressing wood floors have done so through a process of trial and error, using a variety of techniques to create different effects. Hand-scraping and distressing a wood floor is a labor-intensive process that requires skill and artistry, and thus requires that contractors charge a premium.



Hand-scraping and distressing techniques

- Hand-scrape the flooring materials on-site after the floor is installed or off-site before installation. Scrape with the grain, avoiding knots. (The raised area of the knots will provide much of the character in the floor and simulate wear patterns.)
- Walnut, oak, hickory/pecan, pine and similar species adapt well to hand-distressing and scraping. Harder species such as maple and some exotics are difficult to scrape and do not lend themselves to the antiqued look.

- Chains, hammers and chisels can be used to create dents and cracks on the wood.
- Drills and ice picks can be used to create worm-hole effects.
- A soldering iron can add burn marks.
- After the character marks are made, many contractors accentuate them by adding black wood filler, resin, acid, inks or dyes. Applying dark stain traps the color in the nooks and crannies of the floor.
- Experiment on test pieces.
- Bid distressed floor jobs accordingly—they require more labor than typical installations. When scraping the floors off-site, charge for the actual number of feet to be scraped—usually more than the amount to be installed.
- Make samples and obtain client approval before proceeding.

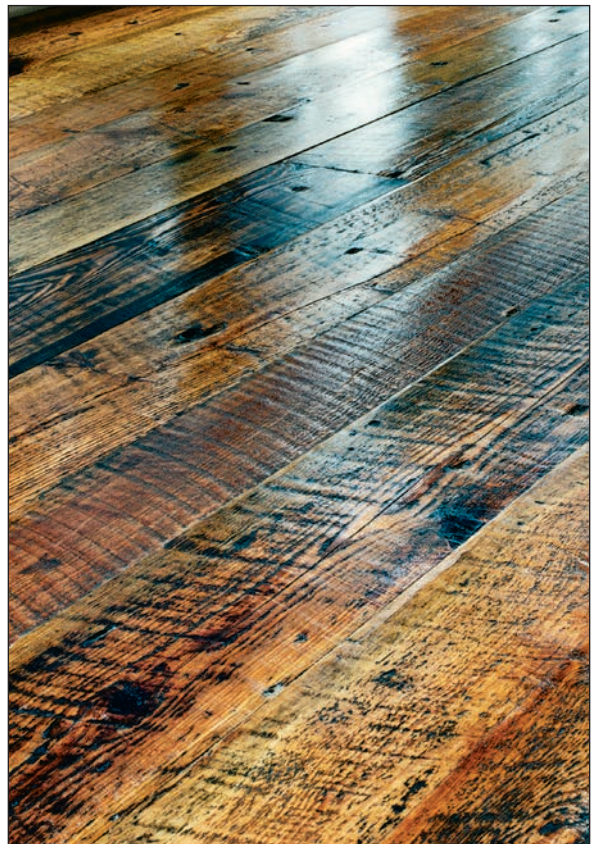



The side of a chisel creates dents.



A 4-inch circular grinder creates dish out.



An awl creates worm holes.



A hand-scraper pillows edges.



Using a chisel to create chips.



A hookscraper emphasizes the worn look.



The edge of a putty knife creates larvae trails.

PAINTING AND STENCILING

PAINTING AND STENCILING HARDWOOD

floors—often called faux finishing—can create effects mimicking virtually any species of wood, and they can also represent inlays and other designs. Always prepare a sample for approval.

BE AWARE THAT FINISH manufacturers may not warrant application of their products over painted or stenciled floors. Check with the finish manufacturer for compatibility with their finish system.



Preparing the floor

- The wood floor should be sanded with a minimum 120-grit abrasive.
- For a painted floor, the wood floor should have a minimum of two base coats of finish.
- Intercoat abrade the area with 220-grit abrasive.

Tape method

- Apply non-marking, easy-release tape in the desired design or pattern.
- Ensure tape edges are secure. To prevent bleed-through, use a roller or the back of a spoon to burnish the inside edge of tape.
- When using dye, it may help to apply clear tape barely overlapping the top of the easy-release tape to prevent bleed-through. Use a 220-grit sandpaper to lightly burnish the finish inside the tape.
- Apply paint or stain/dye.
- Remove the tape after application, pulling at a shallow angle.
- After the paint or stain is dry, apply a minimum of two coats of finish.

Self-adhering stencil method

- Pressure-sensitive adhesive stenciling paper is available at most art supply stores. It is often paper sandwiched between transfer paper and waxed backing. This allows you to cut the pattern, often off-site. (Complicated patterns can often be outsourced to graphic sign makers.) The transfer paper holds the design together until it is placed on the floor. Once adhered to the floor, painting or stenciling proceeds much faster.
- Pre-release the stencil from the paper by burnishing with a plastic taping knife on a hard surface on both sides.
- Lay the stencil with the backing paper facing up.
- Slowly pull the backing paper off at a 180-degree angle backwards.
- Affix the exposed adhesive side to the wood floor.
- Burnish the stencil to the floor.
- Pull the transfer paper off at a 180-degree angle backwards.
- Apply the paint or stain/dye. Use a small amount of paint, stain or dye, and use a dabbing motion along the edges to help alleviate bleeding underneath the stencil.
- Remove the stencil after application, pulling at a shallow angle.
- After the paint or stain is dry, apply a minimum of two coats of finish.

Three of the more popular faux finishing techniques reproduce the look of exotic species, bird's-eye maple or marble. Here are the techniques:

Exotic species technique

The following steps and photos detail how to make maple appear to be mahogany, but different color paints can replicate other species, as well. A single application of a black base can replicate wenge; using one layer of raw sienna creates a teak color, for example.



- **Step 1:** Use easy-release tape to carefully mark off the areas to be painted, and roll the tape to ensure a good bond at the edges.



- **Step 2:** Once the floor is taped off, it must be abraded. Use a grit of at least 200; here the board is being abraded with 320. If you're doing a large area, you can use a buffer and a maroon pad. Abrading the floor helps the tints stick to the floor and also heats up the tape, creating a better bond at the edges. After abrading, tack the floor with a slightly wet cloth.



- **Step 3:** Now brush on the base coat. Here, to replicate mahogany, I'm using a latex water-based artist tint in a terracotta color and applying it with a brush. When imitating other species, always match the base coat to the background color of that species. Once the tint is dry, apply a finish coat of whatever floor finish you're using.



- **Step 4:** Note that for all these steps, the tints and finishes may require more dry time than you expect. Once the finish is dry, use a sponge to wet the area.



- **Step 5:** Dilute your next color—here, raw umber—with water. Then apply the raw umber with a long smooth stroke down the board.



- **Step 6:** Next, immediately go over the same area, but this time, slightly jiggle the brush back and forth as you go down the board, creating the look of grain. To soften the effect, just barely touch the tint in a back-and-forth motion with a makeup brush.



- **Step 7:** To create a fleck effect, you can use a small paintbrush or the tip of your finger and then lightly go over the area with the makeup brush.

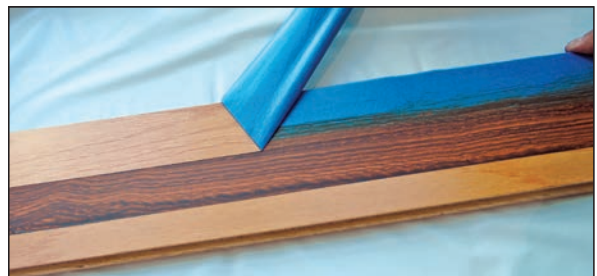

- **Step 8:** Once the tint is completely dried, apply another coat of finish. Remove the tape before the finish dries (remember to pull the tape away at the correct angle).

Marbling & stone technique

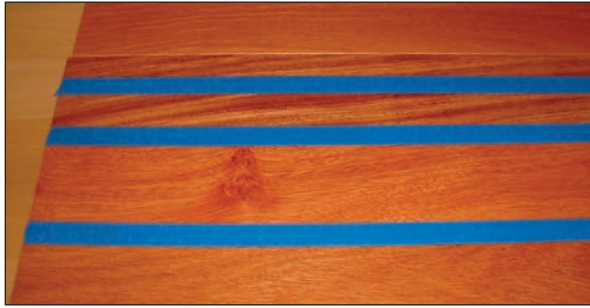

- **Step 1:** Latex paints can be applied over a floor with at least two coats of well dried surface finish or over any factory-finished product. Using a long-lasting, easy-release tape, lay out and tape off the design, making sure the tape is properly secured by rubbing the edges. Lightly sand the areas to be painted with 120-grit or higher sandpaper, making sure the finish powders lightly. As you sand, slightly overlap onto the tape.

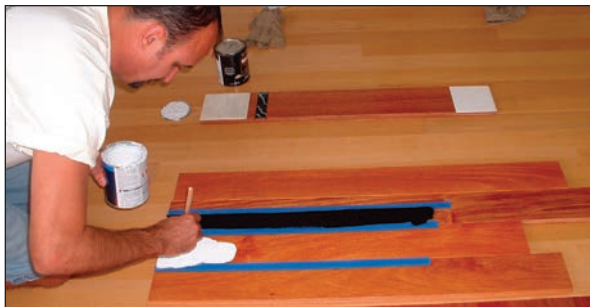

- **Step 2:** Vacuum and tack the area of the design and the surrounding areas. Paint the latex base coats according to your drawings. Remove the tape while the paint is still wet. Then, allow the paint to dry thoroughly (a minimum of 24 hours or more depending on job-site conditions).



- **Step 3:** Re-tape the borders, securing the tape well. Then, for the stone effect, use the appropriate sponge, applying the texture to match the approved sample.



- **Step 4:** Brush the sponge-applied texture to achieve the final effect in the stone sample.



- **Step 5:** Use a small brush to hand-paint the vein effect of the desired marble.



- **Step 6:** With a slightly bigger brush, smooth the veining while it is still wet, working in all directions and pushing down until the paint matches the sample.

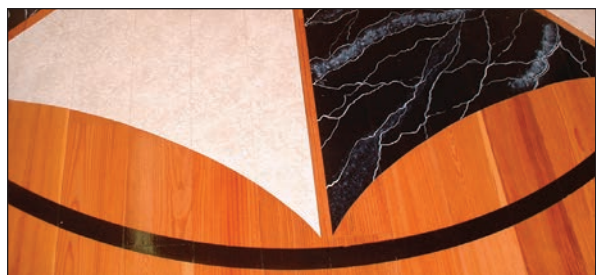

- **Step 7:** After the paint is completely dry, finish the floor with a minimum of two or three coats. Always use the same finish that was used on the original coats (for prefinished flooring, check with the flooring manufacturer for finish compatibility). As an added detail, different sheen levels can be used on different textures and finishes.

SPECIALTY INSTALLATIONS



Bending wood

The ability to bend wood adds a distinctive touch to any wood flooring installation. The ability to offer something unique can eliminate competition based on price alone.



Step 1: Assemble the tools and supplies

Gluing up the board, once started, must proceed without interruption. It is important to have everything

needed before starting.

Step 2: Choose a board suitable for bending

- It should have straight grain without large knots. Small knots are best avoided.
- Rift-cut wood is ideal.
- Woods such as oak, ash, and wenge hide the lamination seams better than woods like maple, birch and ebony.
- Figured woods like tiger or bird's-eye maple, flame birch, curly cherry and quilted mahogany do not bend well.
- Because the last 8 to 12 inches of the bend do not hold the bend, the board must be longer than required. Generally, you will need to bend boards at least 7 feet long to get a 5-foot piece.
- The board must be wider than the finished piece (to allow for the cutoff) and thicker than the finished piece (so it can be planed flat). You may want to use a sacrificial strip outside the assembly to not dent the inlay edge.
- There are two methods to create the necessary bent piece: make a bent radius the full thickness of the flooring, or the preferred method, which is to create an engineered assembly (the bent radius from wood not as thick as the flooring glued to a flat substrate such as plywood). The latter method provides a flat surface and greater dimensional stability.

Step 3: Design and construct the bending template/form

- The form is typically cut from plywood thick enough to accommodate the bent pieces.
- Make the template/form as thick as the wood to be bent, to allow cross braces that hold the wood flat until the glue cures. This may require a bending template/form with two sheets of plywood glued and screwed together.
- A true radius curve is the easiest to make. Cut the radius with a router attached to a track system or radius arm. A radius arm can be constructed from plywood or other materials, with the center point anchored by a screw allowing the arm to turn freely.
- For other curves, scribe the curve onto the plywood and cut the curve as close as possible to the scribed line. Then use a belt sander or a multipurpose sanding tool to plane the edges to the scribed line.
- A laser-cutting firm can make custom forms and templates for unusual curves.

Step 4: Rip the board

- Prior to ripping, square and mark the center line of the board. The center line will be matched up with the center point on the bending template/form.



- Mark the board so that it can be reassembled in the proper order. One method is to mark a "V" on the top side of the board. If more than one board is to be bent, add parallel lines to one or both sides of the "V".
- Use a thin-kerf saw blade with a zero-clearance table saw insert.
- Make the strips thin enough so they bend easily to the radius. Generally, a 1/8 inch thickness works well for tight bends, and up to 1/2 inch can be used for gentle bends.



- Once the board is ripped, put it in order (using the marks made earlier for guides).

Step 5: Gluing up the laminations

It is essential to follow the adhesive manufacturer's directions and choose an adhesive with the proper working time. Polyurethane adhesive is preferred. It is the most commonly used, has good open time (except in a humid climate), bonds well, hides the joints well and accepts stain and finish well.

- Do a dry run before applying adhesive.
- Lay the assembled pieces on a clean, flat surface. Put plastic down to keep the adhesive off the surface and act as a bond break.



- Check the center line and the other marks to see that the pieces are aligned.



- Lay the pieces down sideways and apply the adhesive evenly to fully cover the wood. Do not apply adhesive to the last strip.
- Stand the strips back up and line them up, checking the "V" markings again.

Step 6: Bending the assembly against the template/form

- When making an engineered piece, secure the plywood substrate to the assembling table or the subfloor. Apply adhesive to the substrate where the bent pieces will be laid and apply surface pressure to ensure a tight bond.



- Apply masking tape to the leading edge of the template/form so that the bent assembly will not become glued to the template/form, or wrap the bent wood in plastic wrap.
- Screw the template/form down to the assembly table or subfloor, using screws seated flush.

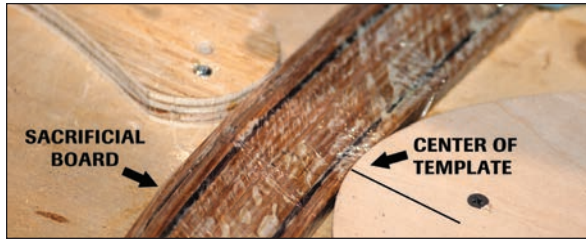

- Line up the center line on the assembly with the center line on the template/form, and install the first cam, wedge or clamp at that center point. Use a sacrificial strip so as not to dent the edge of the bent wood. When using cams or wedges, put a cross brace over the assembly to hold it flat and screw the brace down at the center. When using the clamp method, do the cross-bracing after the assembly is bent.
- When building an engineered piece, bend the entire assembly into place, and apply cams, wedges or clamps toward the ends, but do not fully tighten them. This will limit the exposure of the adhesive on the substrate and prevent it from curing before assembly is completed.



- Continue installing the cams, wedges or clamps. Pressure applied by the cams, wedges or clamps should pull the laminations toward the end of the assembly, rather than pushing the laminations toward the middle. Use as many cams, wedges or clamps as possible.



- Install cross-braces as need.
- The ends of the boards will resist bending, and may not hold the bend. Apply extra cams or wedges toward the ends.
- When using the clamp method, wedges or cams can be installed at each clamping point after the assembly is bent against the template/form. The clamps can then be removed and cross-braces put in place across the top of the assembly.

Step 7a: Cleaning up the assembly

- Make sure the adhesive is fully cured. Overnight (24 hours) is always safe.
- Take off the cams or wedges and the cross braces in the reverse order.



- Remove excess glue with a scraper and run the bent wood through the planer, bottom side down on the first pass. Continue planing the board until it is the proper thickness.
- Use a scraper to clean the side of the piece.

Step 7b: Cleaning up an engineered assembly

- With a jigsaw, roughly cut the plywood to within about ¼ inch of the bent wood.
- Plane the board to thickness, and scrape the sides to clean off the adhesive.
- With a piloted router bit, rout the plywood flush with the bent board. It is generally best working from the bottom of the board to avoid damage to the board.

Step 8: Installing a curved assembly

- The form used to bend the curved piece can be employed as an installation template for a router with a top-mounted bearing bit.
- To cut for both sides of the curved piece requires two templates, since the radius of each side will be different. If it's a true curve, swing another arc with the router on an arm. Remember to accommodate the width of the bit on the inside and outside arcs.
- Planing the bottom edge of the bent wood/plywood will make installation easier.
- Apply adhesive to the subfloor in a thickness that will match the overall elevation of the floor.
- Install the bent wood, weighting it to ensure a good fit, and follow the adhesive manufacturer's recommendation for ventilation, application and drying time.
- If there are gaps, use the sliver method described on page 32.

Making/using eccentric cams

An eccentric cam is a teardrop-shape that rotates on an off-center axis.

Making the cams

- Make the cams the same thickness as the bent wood.
- Drill a hole off-center in the round part of the cam. This will be the pivot point.
- Drill a second hole to hold the cam once it's been tightened against the bent wood.
- One cam every 4 to 6 inches along the bent wood is recommended.
- Use high-strength screws. The screws need to be at least an inch longer than the thickness of the cams.

Using the cams

- Place the cam tightly against the sacrificial board and screw it down.
- Rotate the cam until tight and anchor in place with the second screw.
- Once the first cam is in place at the center point, bend the wood as close to the template/form as possible and anchor a cam at each end. Then work your way from the center cam toward the ends, alternating sides as you anchor the cams tightly.

Making and using wedges

- Wedges must be uniform in size so they are interchangeable.
- Wedges should be about 5 inches long, tapering from 2 inches to 1/8 inch wide.

Using the wedges

- To use wedges to force bent pieces against the form, screw down blocking pieces around the perimeter of the form, about 2 inches outside the radius where the final piece will be installed.
- After the pieces to be bent are put in place, use pairs of wedges to force the pieces against the form and secure the bent pieces in place.

Making and using a sliver template

It is easiest to cut a supply of slivers back at your shop so you have them on hand when you need them at the job site. A PVC tube with caps on each end makes an easy sliver storage unit. Cut slivers of all the species you use.

- **Step 1:** To make slivers, standard flooring boards may be used. Dimension lumber is another option. Boards that are 18 to 20 inches long are easiest to cut slivers from. Ripping to about 3/8 inch is a good thickness.

- **Step 2:** Use blue tape on the table saw or zero-clearance insert to prevent slivers from falling through the gaps next to the blade.
- **Step 3:** Always use safe table saw technique—wear safety glasses and use a push stick to push the board through the blade. Set the blade height so it just comes through the top of the board.
- **Step 4:** Cut off both the tongue and groove sides of the board.



- **Step 5:** Set the blade on a 7-degree angle and adjust its distance from the fence for the width of the board.



- **Step 6:** Cut a thin sliver from both sides of the board. It may take some adjustment and practice before getting the cut you want. Different species vary in density and cut differently.
- **Step 7:** Adjust the blade back to 90 degrees and cut slivers from both sides of the board. As you go through the process, you'll need to adjust the distance of the blade from the fence.



- **Step 8:** A good-quality sliver has a fine, smooth edge. Discard slivers that have a ragged edge.

Installing slivers



The best way to disguise a gap between boards such as the one against the French knot above is to use the slivering technique.



- **Step 1:** Use a razor knife to cut the sliver to the necessary length.



- **Step 2:** Apply wood glue to one side of the sliver. Use the appropriate glue such as PVA. The glue must be strong enough to hold the sliver during the sanding process.



- **Step 3:** Insert the sliver with the narrow side down. If the gap is too narrow for the sliver to go in deep enough, a razor knife can be used to slightly expand the gap.



- **Step 4:** The knife can then be used to tap the sliver down. To withstand several sandings and have holding power in the floor, most of the sliver should go down into the gap.



- **Step 5:** With the sliver down as far as it will go, use the razor knife to score both sides of the sliver at the floor line, slicing off the excess.



- **Step 6:** To smooth the sliver perfectly even with the rest of the floor, you can use either a small block plane or a sharp hand-scraper.

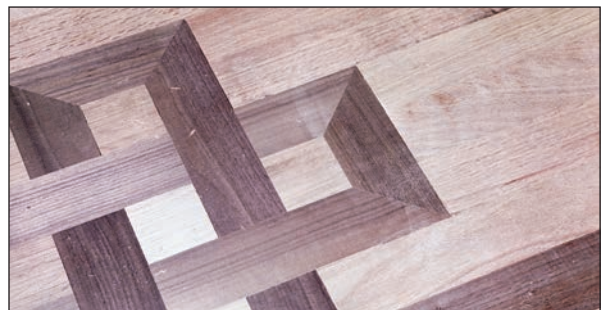

- **Step 7:** Allow the glue to set before sanding the floor.

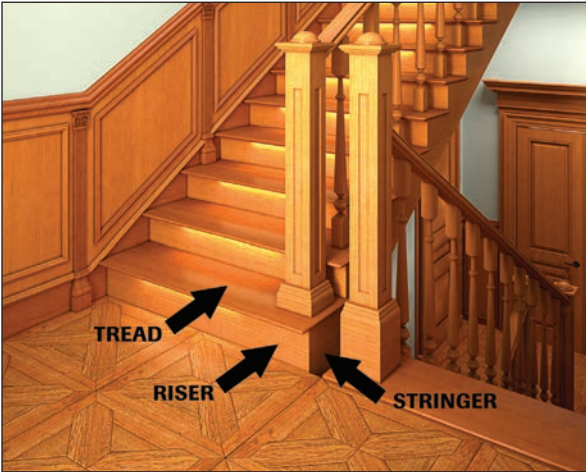

Building stairs

More flooring contractors are taking on the job of constructing stairs. The process described below illustrates one method of installing boxed-in stairs. Be aware, however, the stairs must meet local building codes, which are typically based upon the International Building Code (IBC). It is imperative to check with the local governing building inspector to determine the code requirements governing the work site. For detailed information on IBC stairway codes, refer to the Stairway Manufacturers Association guidelines at www.stairways.org. However, be aware that local governing codes may differ.

Stair replacement and refacing

IMPORTANT NOTE: Be aware that installing a wood floor at the base or the top of an existing stairway may change the riser height of the bottom or top step, taking the stairway out of code compliance. Before installing a wood floor at the base or top of a stairway, check with the local governing building inspector to ensure that the risers will remain within code after installation of the flooring. If not, address this issue with the homeowner or builder before proceeding.

Sometimes a homeowner may desire to have an existing stairway refaced for aesthetic reasons—to match the new wood flooring, for example.

Some flooring contractors have become adept at replacing or refacing an existing stairway, but this can be a complex process requiring experience and expertise, as well as detailed knowledge of code requirements. However, there are also manufacturers who provide custom-made stair risers and treads for that purpose.

IBC for stair treads and risers 1009.3:

- Stair riser heights shall be 7 inches (178 mm) maximum and 4 inches (102 mm) minimum.

- Stair tread depths shall be 11 inches (279 mm) minimum.
- The riser height shall be measured vertically between the leading edges of adjacent treads.
- The tread depth shall be measured horizontally between the vertical planes of the foremost projection of adjacent treads and at a right angle to the tread's leading edge.
- Winder treads shall have a minimum tread depth of 11 inches (279 mm) measured at a right angle to the tread's leading edge at a point 12 inches (305 mm) from the side where the treads are narrower and a minimum tread depth of 10 inches (254 mm).

Most manufacturers produce treads 11¼ inches wide and risers between 7 and 7¼ inches high, which is more than adequate to meet codes in most areas.

Check with the builder or homeowner to determine the finished floor heights for both the upstairs and downstairs. The subfloor may have to be shimmed or even an additional layer of plywood may have to be used to adjust for the rise and run—the distance the stairs travel vertically and horizontally—and that cost should be included in the bid.

Procedure for building stairs

- **Step 1:** Evaluate the stairs to determine that the rise and run does not exceed the acceptable range of variance from the first stair. Follow local building codes, as noted above.



- **Step 2:** Use a level to check the rough tread for flatness and the rough riser for plumb. Shim if necessary to make the angles between the tread and riser 90 degrees.



- **Step 3:** Using the plywood base, accurately measure for the length of the tread. Butt the end of the tape measure against the wall or the skirt and measure to any point in the center of the tread.
- **Step 4:** Reverse the tape measure and measure from the opposite skirt or wall to the same point. Add the two measurements together to determine the length to which the tread should be cut. Repeat this process for the first riser.



- **Step 5:** Use these measurements to cut the tread and riser for the first step. Accuracy is crucial. Miter saws don't cut the closest, and jigsaws can rip out a lot of material, so first use a jigsaw to cut as close to the scribe line as possible.



- **Step 6:** Use a belt sander to sand the treads and risers to the exact length.
- **Step 7:** Repeat Steps 2 through 6 for each stair. Do not use the measurements from the first step, since walls are not perfectly square.



- **Step 8:** Dry-fit the treads and risers. Never force a tread or riser into place. Trim as necessary. Back-cut a slight angle on the riser ends approximately 1/4 inch behind the face to prevent the riser from snagging the drywall and provide a better fit.



- **Step 9:** Kerf the bottom of each tread lengthwise approximately one-third into its thickness. The kerf channel reduces the tension placed on the stair, helps with adhesion and helps prevent cupping.



- **Step 10:** After all the treads and risers are dry-fitted, flatness is acceptable and the rise and run is within code, remove the pieces and sand and finish prior to installation.
- **Step 11:** Use an elastomeric, polyurethane-based adhesive, as well as small-diameter nails, to fasten the stair parts in place.



Enhancing existing floors

An existing wood floor can be transformed by adding feature strips, borders and inlays. It's also possible to take such a floor and make it look rustic through hand-scraping and distressing techniques. (See "Hand-Scraping and Distressing" on page 23.) It may be necessary after installation to sand and refinish the entire floor, so discuss it with the client before beginning.

Inspect the existing floor

Before attempting to install an inlay, border, feature strip or other ornamental element, inspect the floor to check for wear layer thickness, nail spacing and pops and squeaks between the flooring and the subfloor. In a floor over a basement or crawl space, get underneath the floor to check the subfloor for integrity and support.



Installing inlays in an existing floor

Follow the manufacturer's guidelines for installation. However, the general guidelines detailed in "Installing Inlays" on page 15 may be useful. The steps for installing inlays in an existing floor are almost exactly the same as those for installing an inlay in a new

unfinished floor, although of course precautions must be taken not to damage the existing flooring.

Installing feature strips in an existing floor

A simple method to add a decorative touch is to install ¼-inch-deep feature strips that can be cut into the floor. Trace the design on the floor and use a magnetic nail finder to locate any nails along the design lines. Use a plunge router and bit to rout a ¼-inch-deep hole the width of the strip to be installed. Clean out the hole, dry-lay the feature strip to ensure proper fit, and glue the feature strip into the hole.

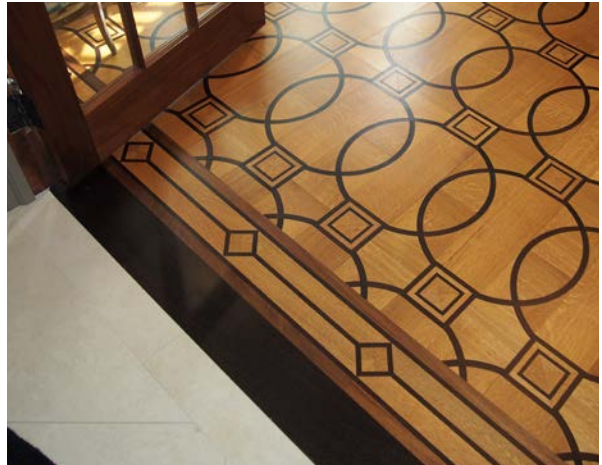

Installing an ornamental border in an existing floor

Another ornamental element can be created by using a straight-edge and saw to cut out a space for a border and apron around the perimeter of the room or around another design element. The process is similar to board replacement and may be challenging, since there will be a tendency for the existing floor to "close up" around the space. Take care when removing the boards to ensure that the cuts are square and tight. It may be necessary to install feature strips on the outside of the border to obtain the proper fit.

Being creative with factory-finished flooring

Most manufacturers of borders and inlays offer products that are factory-finished and designed to match the thickness and approximate the sheen levels of factory-finished flooring. Take care to protect the surface of factory-finished flooring during installation.

As with installation of ornamental elements in an existing floor, it may be necessary after installation to sand and refinish the entire floor, so discuss this with the client.

Detailed instructions for installation of inlays can be found on page 15. However, there are some caveats when installing ornamental elements in a factory-finished floor:



- Ensure that additional flooring is on hand in case a board needs to be replaced during the process.
- Identify the brand, color and style of factory-finished flooring in case additional flooring is needed.
- Use a caliper at floor registers, in closets or at transitions to determine floor thickness.
- Check subfloor conditions for flatness, integrity and support. On concrete slabs, it may be necessary to grind the slab to provide proper flatness.
- Dry fit the inlay, border or feature strip to ensure proper fit before gluing the element into place. It is easier to raise the design element to the proper height than it is to sand the element down to the level of the floor.
- Follow the guidelines provided by the manufacturer of the flooring, inlay, border or feature strip.

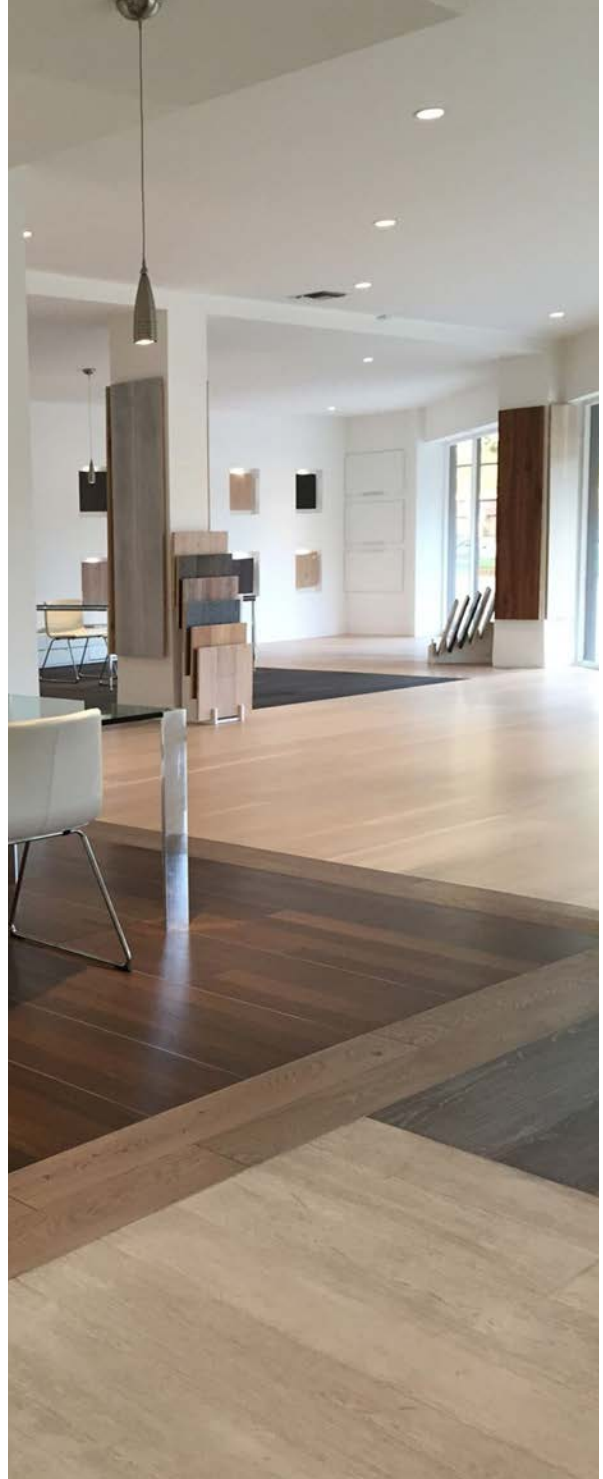

SOURCES AND CREDITS

NWFA Technical Manual Committee

- Janet Sullivan, Lenmar Inc., Chair
- Sprigg Lynn, Universal Floors Inc., Board of Directors Liaison
- Don Conner
- Johannes Boonstra, Rubio Monocoat
- Craig Dupra, Installers Warehouse Inc.
- John Freeto, WoodCraft Wood Floors Inc.
- Mike Johns, Bostik Inc.
- Mike Kearns, Primatex Inc.
- Neil Moss
- Kevin Mullany, Benchmark Wood Floors Inc.
- Jim Schumacher, 3M

Publication Editors

- Kim Wahlgren, *Hardwood Floors*

Art Director

- Scott Maurer, *Hardwood Floors*

Photo Credits

- Page 2: Top photo courtesy of Palembang Hardwood Floors Inc.; middle photo courtesy of Majestic Wood Floors Inc.; bottom photo courtesy of Universal Floors Inc.
- Page 3: Courtesy of Yarema Marquetry.
- Page 5: Top photo courtesy of Schenck & Company; bottom photo courtesy of Alberta Hardwood Flooring Ltd., ©Merle Prosofsky.
- Page 6: Top photo courtesy of Schumacher & Co. Inc.; bottom photo courtesy of Scheller Hardwood Flooring.
- Page 7: Photo courtesy of *Hardwood Floors*.
- Page 10: Top photo courtesy of Majestic Wood Floors; bottom photo courtesy of *Hardwood Floors*.
- Page 11: All photos courtesy of *Hardwood Floors*.
- Page 12: All photos courtesy of *Hardwood Floors*.
- Page 13: Top left photo courtesy of Oshkosh Designs; top right column photo courtesy of Apex Wood Floors.
- Page 13-14: Herringbone pattern illustrations courtesy of Kjell Nymark, Precision Hardwood Floor Services, Inc.
- Page 15: Top left photo courtesy of Netwood Timber Trading; bottom left photo courtesy of Bill Howard Floor Co. Inc.; photos in right column courtesy of *Hardwood Floors*.
- Page 16: All photos courtesy of *Hardwood Floors*.
- Page 17: Top left photo courtesy of Birger Juell Ltd.; bottom left photo courtesy of Weitzer Parkett; bottom right photo courtesy of Schenck & Company.

- Page 18: Top three photos courtesy of *Hardwood Floors*; bottom right photo courtesy of Seabaugh's Custom Hardwood Floors.
- Page 19: Courtesy of Oshkosh Designs.
- Page 20: Courtesy of Koetter Woodworking.
- Page 22: Courtesy of Washington Street Hardwood Floors & Décor.
- Page 23: Photo on left courtesy of DM Hardwood Designs; photo at right courtesy of Schenck & Company.
- Page 24: All photos courtesy of *Hardwood Floors*.
- Page 25: Courtesy of HardwoodFloorsOnline.com.
- Page 26: All photos courtesy of *Hardwood Floors*.
- Page 27: All photos courtesy of *Hardwood Floors*.
- Page 28: Top photo courtesy of Endurance Floor Company; bottom photo courtesy of Schenck & Company.
- Page 29: All photos by NWFA.
- Page 30: All photos by NWFA.
- Page 31: Top, center photos by NWFA; bottom photo courtesy of *Hardwood Floors*.
- Page 32: All photos courtesy of *Hardwood Floors*.
- Page 33: Top photo by iStockphoto; bottom photo courtesy of Steve Marley.
- Page 34: All photos courtesy of Steve Marley.
- Page 35: Top left photo courtesy of Divine Hardwood Flooring; bottom left photo courtesy of Gaylord Hardwood Flooring; right column photo courtesy of Buffalo Hardwood Floor Center.
- Page 36: Top left column photo courtesy of WD Flooring, LLC; Bottom left column photo courtesy of Yantarnaya Prayd-Parquet; right column photo courtesy of Natural Wood Floors & Design.

Publications

Stair Building Code: 2012 International Residential Code, Stairway Manufacturers' Association.



111 Chesterfield Industrial Boulevard, Chesterfield, Missouri 63005
[P] 800.422.4556 [F] 636.519.9664 [W] www.nwfa.org