



V-BOX PRO 48A

EV Charging Station
(WiFi Version)

USER MANUAL



CONTENTS

What's Included	3
Safety Instructions	4
LED Status Indicators	5
Installation	7
Adjusting Charging Current	9
Hardwiring the V-BOX Pro	10
Accessing the Lectron App	11
Charging Your Vehicle	13
Disconnecting Your Vehicle	13
Specifications	14
Get More Support	15

WHAT'S INCLUDED

V-BOX PRO 48A EV Charging Station

Screw + anchor set
(for mounting plate)

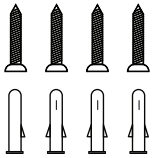

Screw covers



Small screw + screw cover set
(for V-BOX Pro)

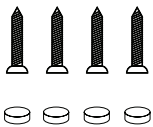

Small screw + anchor set
(for J-hook)

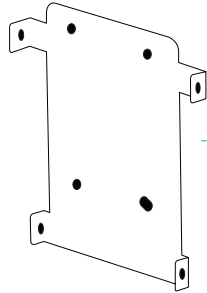
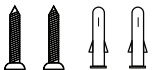

Mounting plate

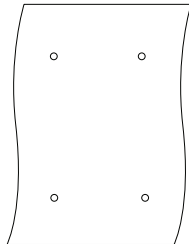

Drill reference paper

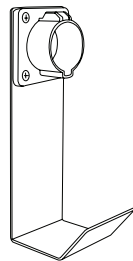

J-hook

1 x V-BOX Pro Charging Station

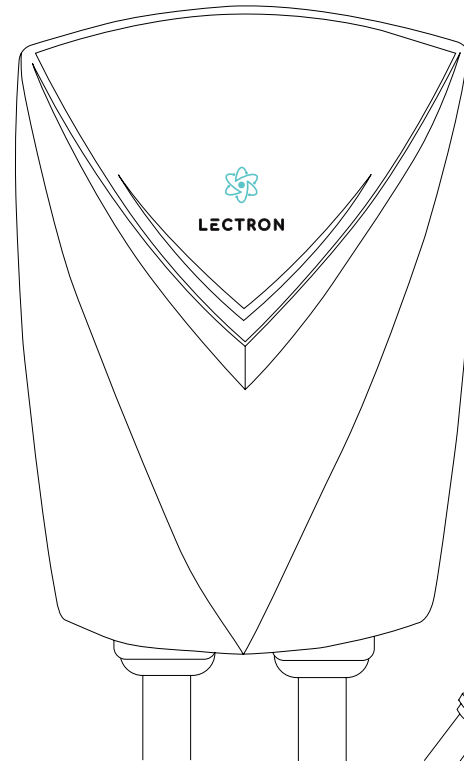

Charging handle
(J1772)

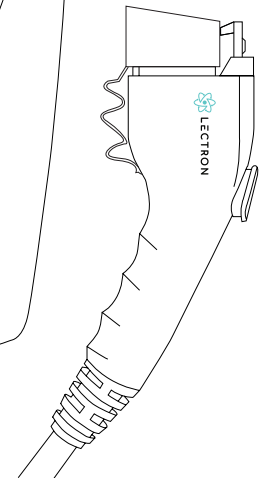

COMPATIBILITY



NEMA 14-50
(240 V)



J1772
Connector







SAFETY INSTRUCTIONS

- It is highly recommended that the installation of electrical outlets for use with the V-BOX Pro Charging Station be conducted by a licensed and qualified electrician. The installation should adhere to the National Electric Code (NEC) and relevant local codes, with local codes taking precedence in case of conflicts.
 - Proper grounding is essential. The grounding conductor and plug provided with the V-BOX Pro should be connected to a correctly installed and grounded outlet, reducing the risk of electric shock.
 - Avoid dropping or causing damage to the charging station and charging handle.
 - Do not attempt any repairs on the V-BOX Pro. For assistance, please contact customer support at contact@ev-lectron.com.
- Follow these precautions when using the V-BOX Pro Charging Station:
 - Do not use the station with an extension cord or AC adapter.
 - Ensure the plug is fully inserted into the wall outlet to prevent exposed prong surfaces.
 - Supervise children when the station is in use.
 - Only connect to a circuit with a maximum of 60 amps branch circuit overcurrent protection to minimize the risk of fire.
- WARNING:**
- a) Read all instructions before using this product.
 - b) Do not insert fingers into the electric vehicle connector.
 - c) Do not use this product if the flexible power cord or EV cable is frayed, has broken insulation, or shows any other signs of damage.
 - d) Do not use this product if the enclosure or the EV connector is broken, cracked, open, or shows any other indication of damage.

LED STATUS INDICATORS

Status indications are displayed on the V-shaped LED of the V-BOX Pro Charging Station. The Power Button LED on the right-hand side of the unit indicates if the charging station is switched on.

FUNCTION & STATUS INDICATION (V-SHAPED LED)

FUNCTION STATUS	LED COLOR			
	(Red)	(Blue)	(Green)	(Yellow)
No connection to EV				
Connected to EV, communication in progress				
Charging in progress				
Charging complete				
Error/Warning				
WiFi connection failure				



POWER BUTTON (RIGHT SIDE OF STATION)

BUTTON POSITION	LED COLOR		
	(Red)	(Blue)	(Green)
OFF			
ON			

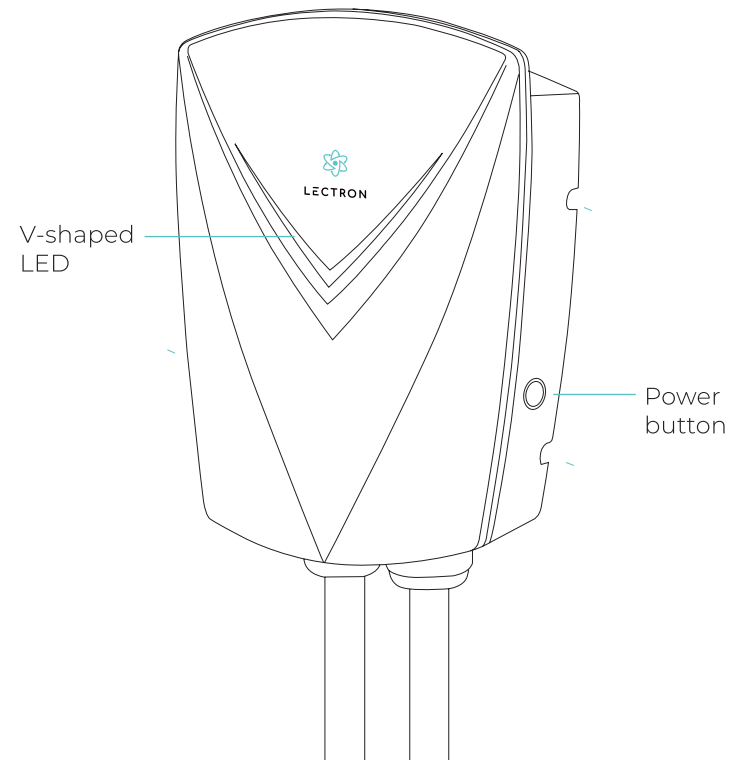
V-BOX PRO CHARGING STATION



ERROR INDICATION (V-SHAPED LED)

FAULT STATUS	RED LED
Control pilot fault	1 flash followed by 2 seconds off, repeating
Input UVP (Under Voltage Protection)	2 flashes followed by 2 seconds off, repeating
Input OVP (Over Voltage Protection)	3 flashes followed by 2 seconds off, repeating
OTP (Over Temperature Protection)	4 flashes followed by 2 seconds off, repeating
OCP (Over Current Protection)	5 flashes followed by 2 seconds off, repeating
Ground fault	6 flashes followed by 2 seconds off, repeating
Relay fault	7 flashes followed by 2 seconds off, repeating
RCD (Residual Current Device) Abnormal	 Blinking
RCD self-test fault	 Solid

FAULT STATUS	YELLOW LED
Network Connection Failure	2 flashes followed by 6 seconds off, repeating

INSTALLATION

1. Use the drilling reference paper to mark the wall for the mounting plate's location.

2. Drill holes at the marked positions using the correct drill and bit size.

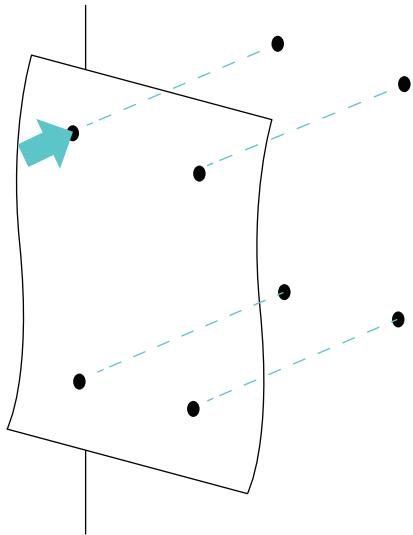

3. Insert wall anchors, align the mounting plate, and attach it firmly.

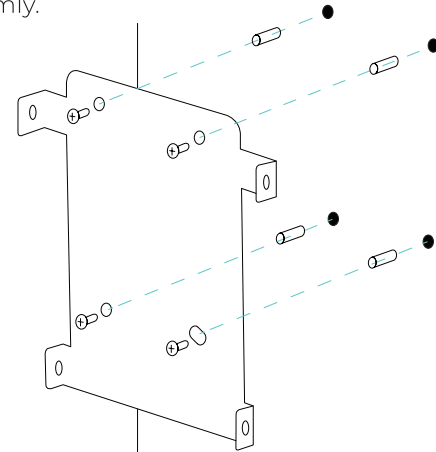

4. Securely attach the J-hook about 8 inches from the mounting plate.

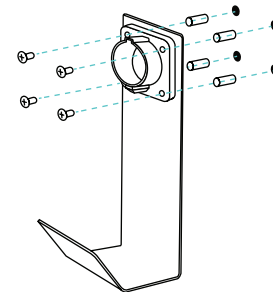

5. Align V-BOX Pro slots with mounting plate tabs and attach.

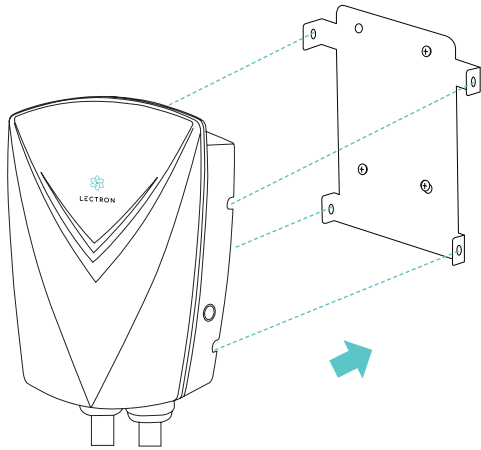

6. Reinsert V-BOX Pro screws, conceal with screw caps.

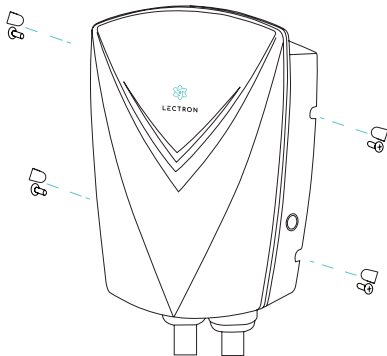

7. Connect the power cable to a NEMA 14-50 outlet. Please note, the unit must be hardwired for 48A; do not use the plug.

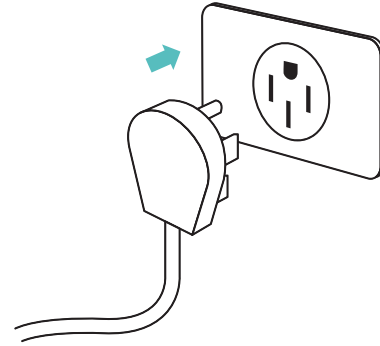

ADJUSTING CHARGING CURRENT

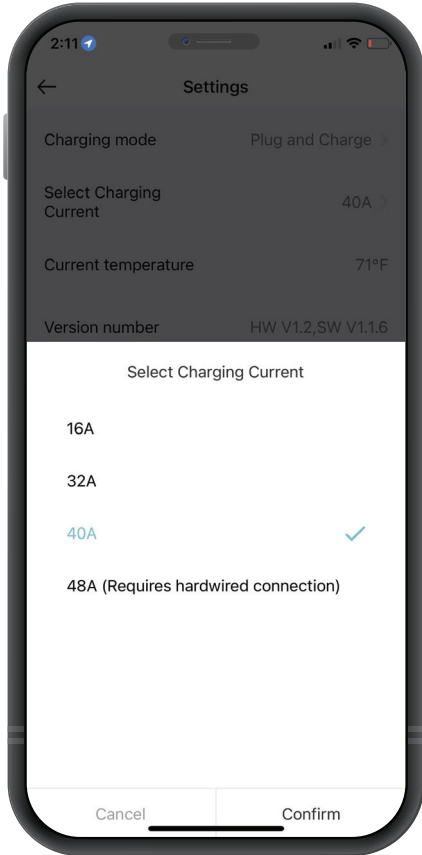

To adjust the charging current (Amps) on the V-BOX Pro using the Lectron App:

1. Ensure that the charger is powered on. Charging current can only be adjusted through the Lectron App when the device is active.
2. Download the Lectron App for detailed control of your V-BOX Pro (refer to page 11: "Access the Lectron App" for download instructions).
3. Within the app, you can select the charging current at four levels: 16A, 32A, 40A, and 48A.
4. The default setting for the charging current is 40A.

Important: To achieve a charging current of 48A, a hardwired connection is required.

HARDWIRING THE V-BOX PRO

Prior to any hardwire installation, deactivate the circuit breaker associated with the relevant electrical circuit. The hardwiring process should be conducted by an electrician with the necessary qualifications.

NOTE:

Grounding Instructions

This product must be connected to a grounded, metal, permanent wiring system. Alternatively, an equipment grounding conductor should be run with the circuit conductors and connected to the equipment grounding terminal or lead on the product.

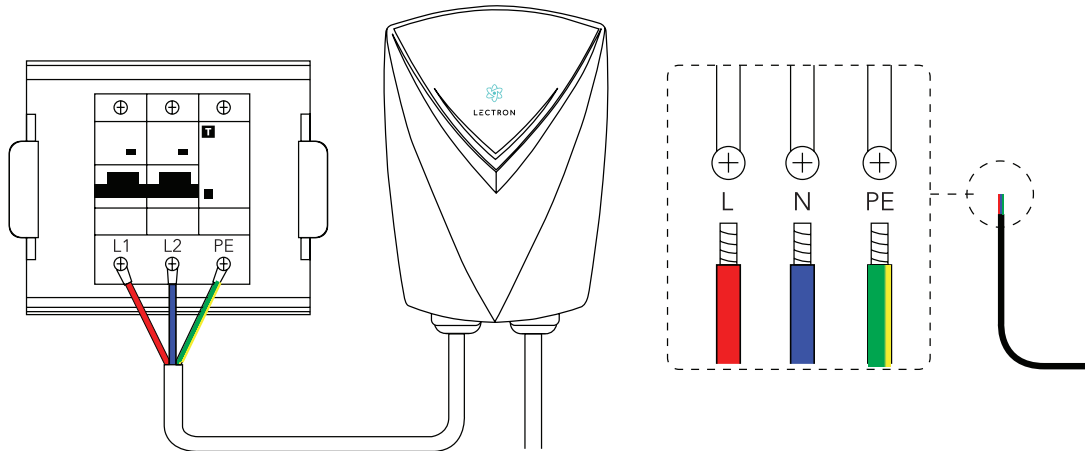

ACCESSING THE LECTRON APP

1. Scan the QR code to download the Lectron App.
Sign up with your email, Google, or Apple account.



2. Access the Lectron App homescreen.

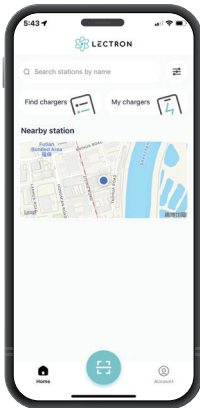

3. Tap "My chargers".

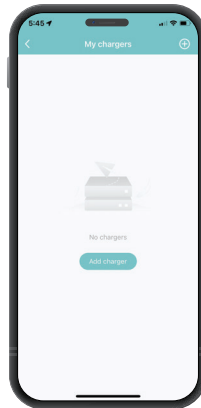

4. Power on the V-BOX Pro. Enable Bluetooth on your phone. Tap "Add Charger" and select V-BOX Pro.

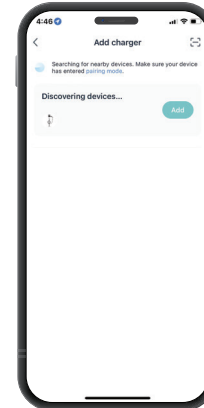

5. Input your WiFi network and password.

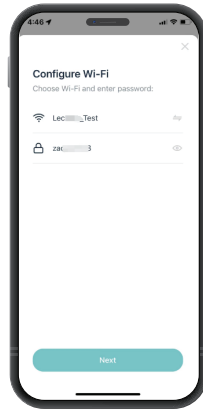

6. Once connected, the V-BOX Pro will be added to your account.

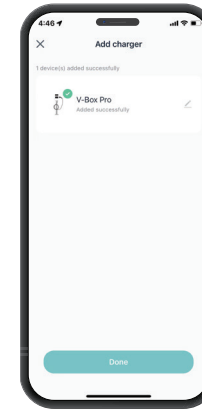

7. You can now manage your V-BOX Pro charger using the Lectron App.

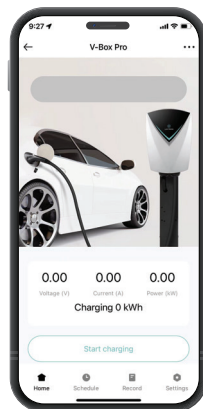

8. Scan the QR code to maximize your experience with the V-BOX Pro.



CHARGING YOUR VEHICLE

Important: Prior to charging, ensure your vehicle is parked and turned off.

1. Attach the charging handle to your vehicle's charging port.

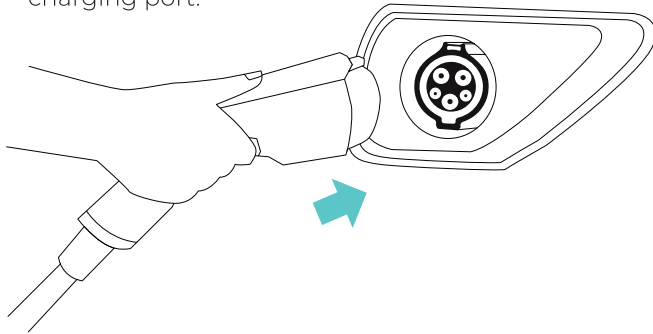

2. Power on the V-BOX Pro by pressing the button located on the right side of the unit. You can also adjust other charging modes on the Lectron APP to start charging. The default is plug and charge mode.
3. Successful charging is indicated by 'rolling green' LEDs on the V-BOX Pro. Verify the status on your vehicle's dashboard.

DISCONNECTING YOUR VEHICLE

1. Solid green LEDs indicate charging is complete. To disconnect, press the button on top of the charging handle.

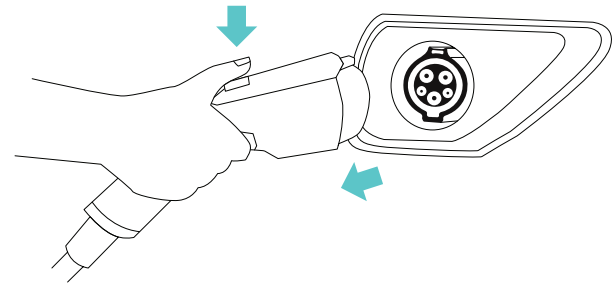

2. Store the charging cable by wrapping it around the J-hook and placing the handle back into the holster.

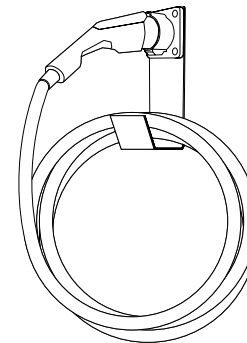

SPECIFICATIONS

Maximum current:	48 A
Current settings:	16 A, 32 A, 40 A(default setting: NEMA plug), 48 A(Hardwired)
Input / output:	208 - 240 V AC
Frequency:	50 / 60 Hz
Cable length:	16 ft
Plug:	NEMA 14-50
EV connector:	SAE-J1772
Dimensions:	17.7 x 13.77 x 10.43 in
Weight:	20.5 lb
Operating temperature:	-22 °F to 122 °F (-30 °C to 50 °C)
Material:	PC and alloy
Storage temperature:	-40 °F to 176 °F (-40 °C to 80 °C)
WiFi:	802.11 b/g/n (channel 1-14) 2.4 GHz
Bluetooth:	BLE5.2



GET MORE SUPPORT

Need assistance? Scan the QR code below or email us at contact@ev-lectron.com

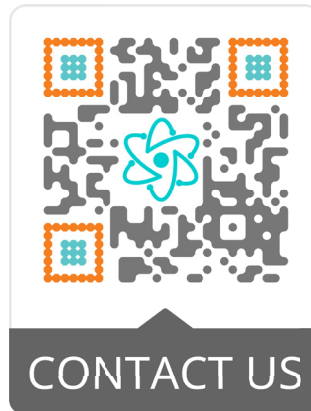

LECTRON

www.ev-lectron.com

Made in China