



V-BOX PRO 48A

EV Charging Station

USER MANUAL



CONTENTS

What's Included	3
Safety Instructions	4
LED Status Indicators	5
Before Installation	7
Installation Guide	8
Hardwiring the V-BOX Pro	10
Charging Your Vehicle	11
Disconnecting Your Vehicle	11
Specifications	12
Get More Support	13

WHAT'S INCLUDED

V-BOX PRO 48A EV Charging Station

Screw + anchor set
(for mounting plate)

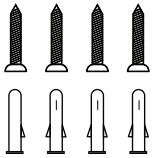

Screw covers

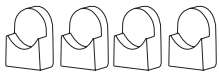

Small screw + screw cover set
(for V-BOX Pro)

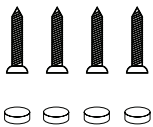

Small screw + anchor set
(for J-hook)

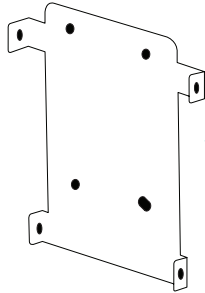
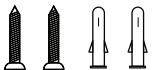

Mounting plate

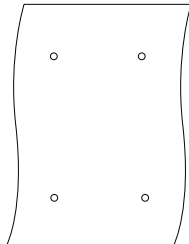

Drill reference paper

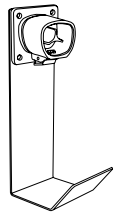

Tesla charger mount

1 x V-BOX Pro Charging Station

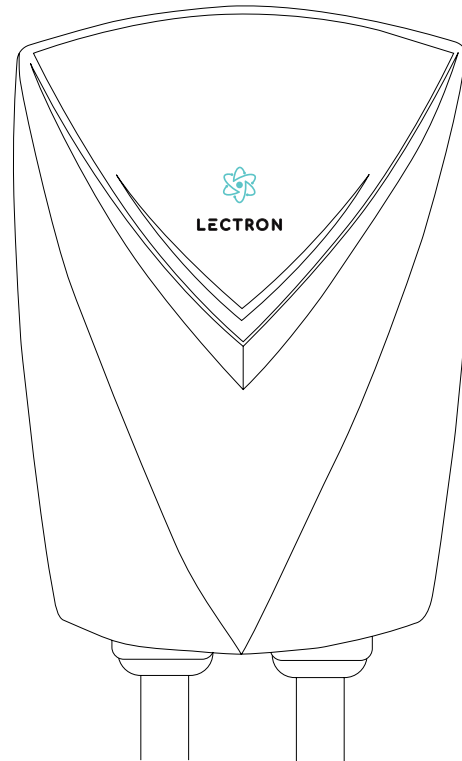

Charging handle
Tesla | NACS

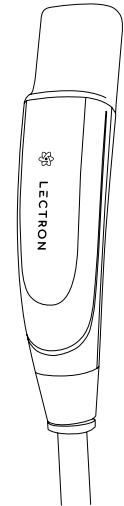

COMPATIBILITY



NEMA 14-50
(240 V)



Tesla | NACS
Connector

SAFETY INSTRUCTIONS

- It is highly recommended that the installation of electrical outlets for use with the V-BOX Pro Charging Station be conducted by a licensed and qualified electrician. The installation should adhere to the National Electric Code (NEC) and relevant local codes, with local codes taking precedence in case of conflicts.
 - Proper grounding is essential. The grounding conductor and plug provided with the V-BOX Pro should be connected to a correctly installed and grounded outlet, reducing the risk of electric shock.
 - Avoid dropping or causing damage to the charging station and charging handle.
 - Do not attempt any repairs on the V-BOX Pro. For assistance, please contact customer support at contact@ev-lectron.com.
- Follow these precautions when using the V-BOX Pro Charging Station:
 - Do not use the station with an extension cord or AC adapter.
 - Ensure the plug is fully inserted into the wall outlet to prevent exposed prong surfaces.
 - Supervise children when the station is in use.
 - Only connect to a circuit with a maximum of 60 amps branch circuit overcurrent protection to minimize the risk of fire.





WARNING:

- a) Read all instructions before using this product.
- b) Do not insert fingers into the electric vehicle connector.
- c) Do not use this product if the flexible power cord or EV cable is frayed, has broken insulation, or shows any other signs of damage.
- d) Do not use this product if the enclosure or the EV connector is broken, cracked, open, or shows any other indication of damage.

LED STATUS INDICATORS

Status indications are displayed on the V-shaped LED of the V-BOX Pro Charging Station. The Power Button LED on the right-hand side of the unit indicates if the charging station is switched on.

FUNCTION & STATUS INDICATION (V-SHAPED LED)

FUNCTION STATUS	LED COLOR		
	(Red)	(Blue)	(Green)
No connection to EV			
Connected to EV, communication in progress			
Charging in progress			
Charging complete			
Error/Warning			



POWER BUTTON (RIGHT SIDE OF STATION)

BUTTON POSITION	LED COLOR		
	(Red)	(Blue)	(Green)
OFF			
ON			

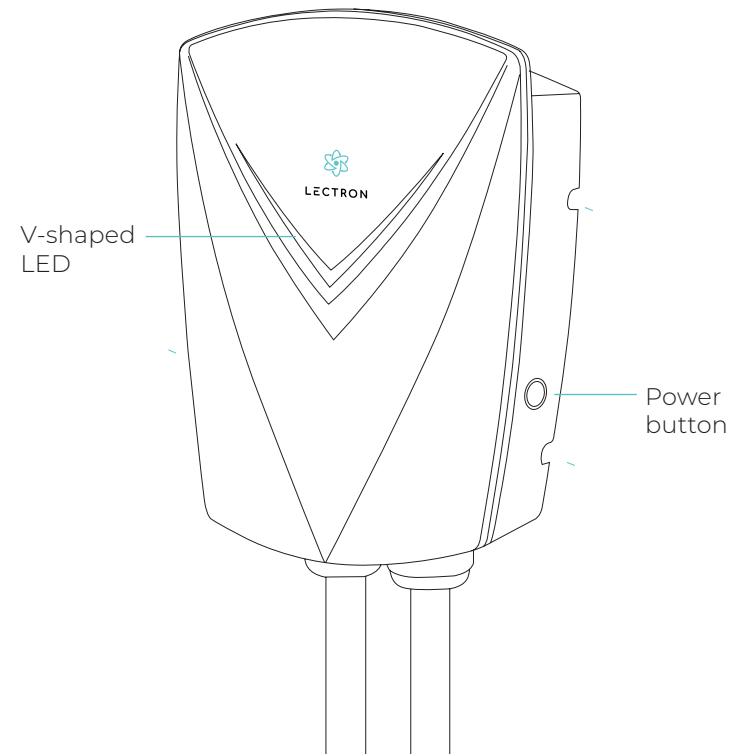
V-BOX PRO DIAGRAM



ERROR INDICATION (V-SHAPED LED)

FAULT STATUS	RED LED
Control pilot fault	1 flash followed by 2 seconds off, repeating
Input UVP (Under Voltage Protection)	2 flashes followed by 2 seconds off, repeating
Input OVP (Over Voltage Protection)	3 flashes followed by 2 seconds off, repeating
OTP (Over Temperature Protection)	4 flashes followed by 2 seconds off, repeating
OCP (Over Current Protection)	5 flashes followed by 2 seconds off, repeating
Ground fault	6 flashes followed by 2 seconds off, repeating
Relay fault	7 flashes followed by 2 seconds off, repeating
RCD (Residual Current Device) Abnormal	 Blinking
RCD self-test fault	 Solid

BEFORE INSTALLATION

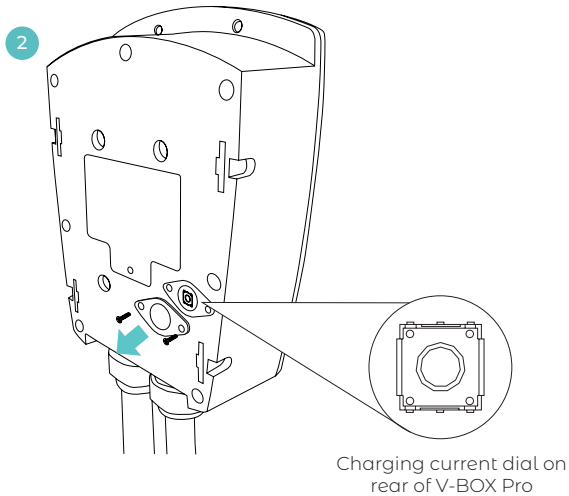
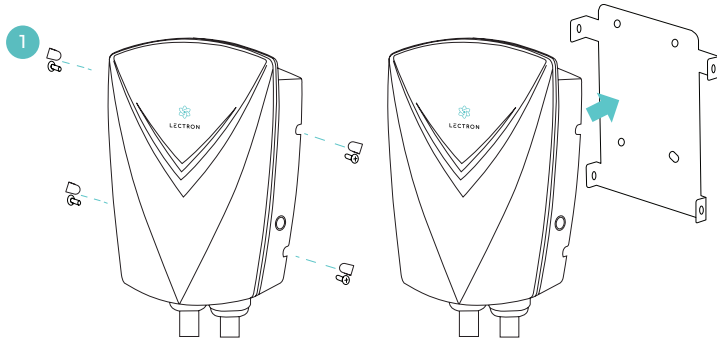

To adjust the charging current (Amps) on the V-BOX PRO:

1. Remove the cover on the back of the V-BOX PRO.
2. Locate the dial and turn it to your desired charging current setting.

Please note that the default current setting is 40A. Increasing the charging current to 48A will require hardwiring.

Charging current dial

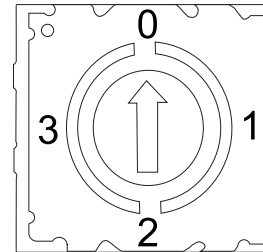

Dial Position	Current (A)
0	16 A
1	32 A
2	40 A
3	48 A

INSTALLATION GUIDE

1. Use the drilling reference paper to mark the wall for the mounting plate's location.

2. Drill holes at the marked positions using the correct drill and bit size.

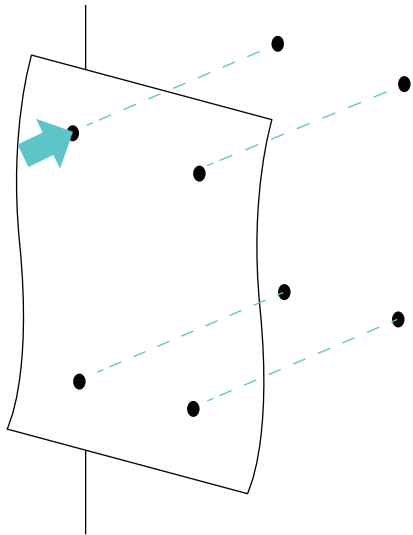

3. Insert wall anchors, align the mounting plate, and attach it firmly.

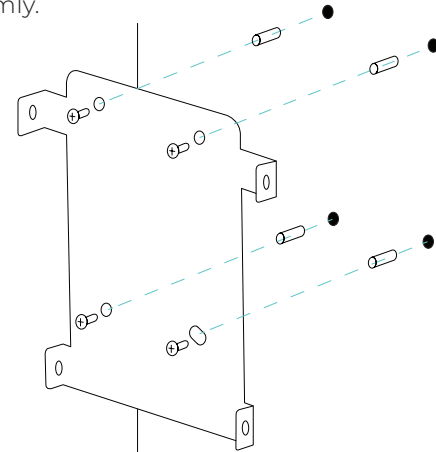

4. Securely attach the Tesla charger mount about 8 inches from the mounting plate.

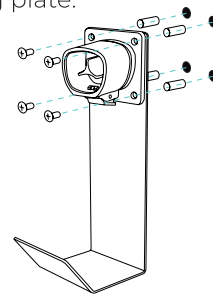

5. Align V-BOX Pro slots with mounting plate tabs, adjust Amp setting, and attach.

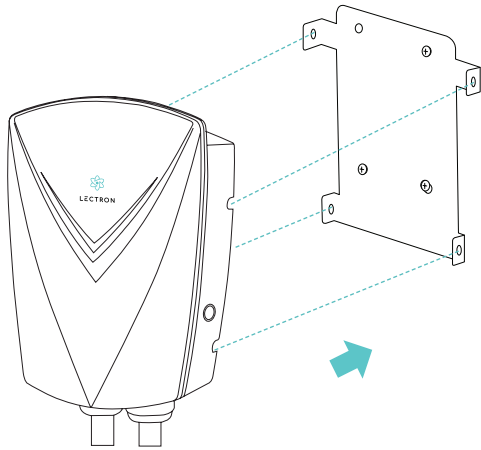

6. Reinsert V-BOX Pro screws, conceal with screw caps.

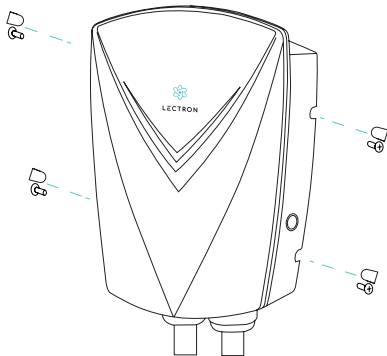

7. Connect the power cable to a NEMA 14-50 outlet. Please note, the unit must be hardwired for 48A; do not use the plug.

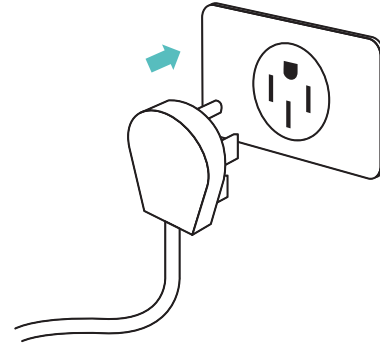

HARDWIRING THE V-BOX PRO

Prior to any hardwire installation, deactivate the circuit breaker associated with the relevant electrical circuit. The hardwiring process should be conducted by an electrician with the necessary qualifications.

NOTE:

Grounding Instructions

This product must be connected to a grounded, metal, permanent wiring system. Alternatively, an equipment grounding conductor should be run with the circuit conductors and connected to the equipment grounding terminal or lead on the product.

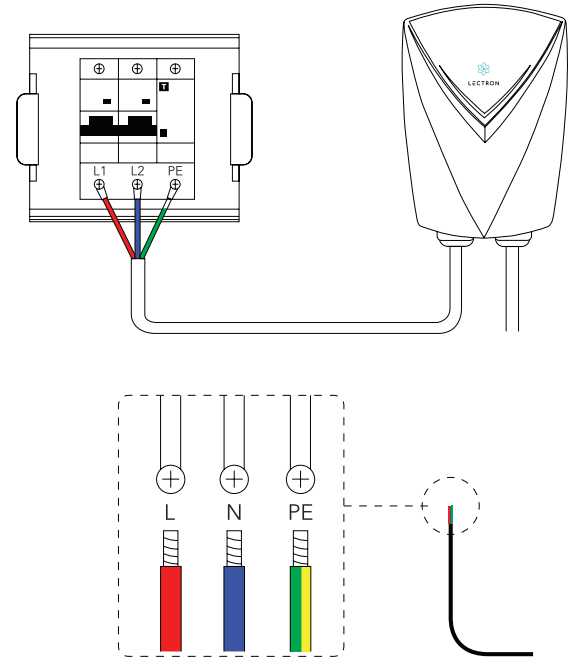

CHARGING YOUR VEHICLE

Important: Prior to charging, ensure your vehicle is parked and turned off.

1. Attach the charging handle to your vehicle's charging port.

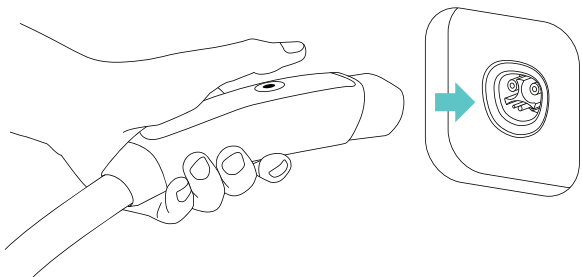

2. Power on the V-BOX Pro by pressing the button located on the right side of the unit.
3. Successful charging is indicated by 'rolling green' LEDs on the V-BOX Pro. Verify the status on your vehicle's dashboard.

DISCONNECTING YOUR VEHICLE

1. Solid green LEDs indicate charging is complete. To disconnect, press the button on top of the charging handle.

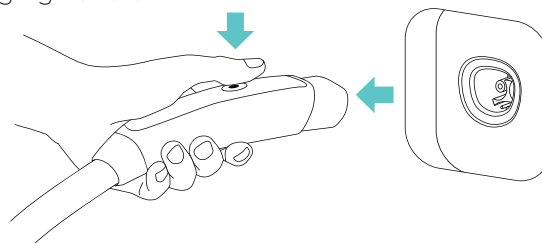

2. Store the charging cable by wrapping it around the Tesla charger mount and placing the handle back into the holster.

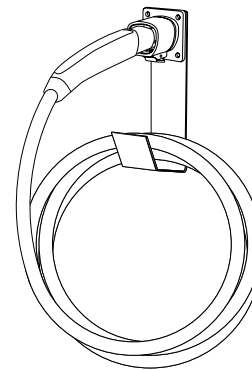

SPECIFICATIONS

Maximum current:	48 A
Current settings:	16 A, 32 A, 40 A(default setting: NEMA plug), 48 A(Hardwired)
Input / output:	208 - 240 V AC
Frequency:	50 / 60 Hz
Cable length:	16 ft
Plug:	NEMA 14-50
EV connector:	North American Charging Standard (NACS) Tesla
Dimensions:	17.x 13.77 x 10.43 in
Weight:	20,5 lb
Operating temperature:	-22 °F to 122 °F (-30 °C to 50 °C)
Material:	PC and alloy
Storage temperature:	-40 °F to 176 ° (-40 °C to 80 °C)



FR



GET MORE SUPPORT

Need assistance? Scan the QR code below or email us at contact@ev-lectron.com

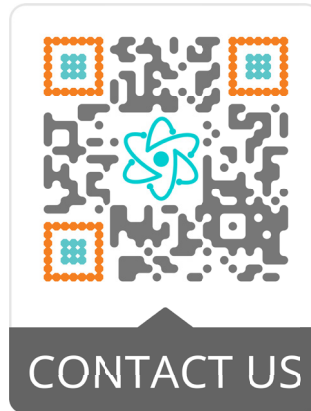

LECTRON

www.ev-lectron.com

Made in China