

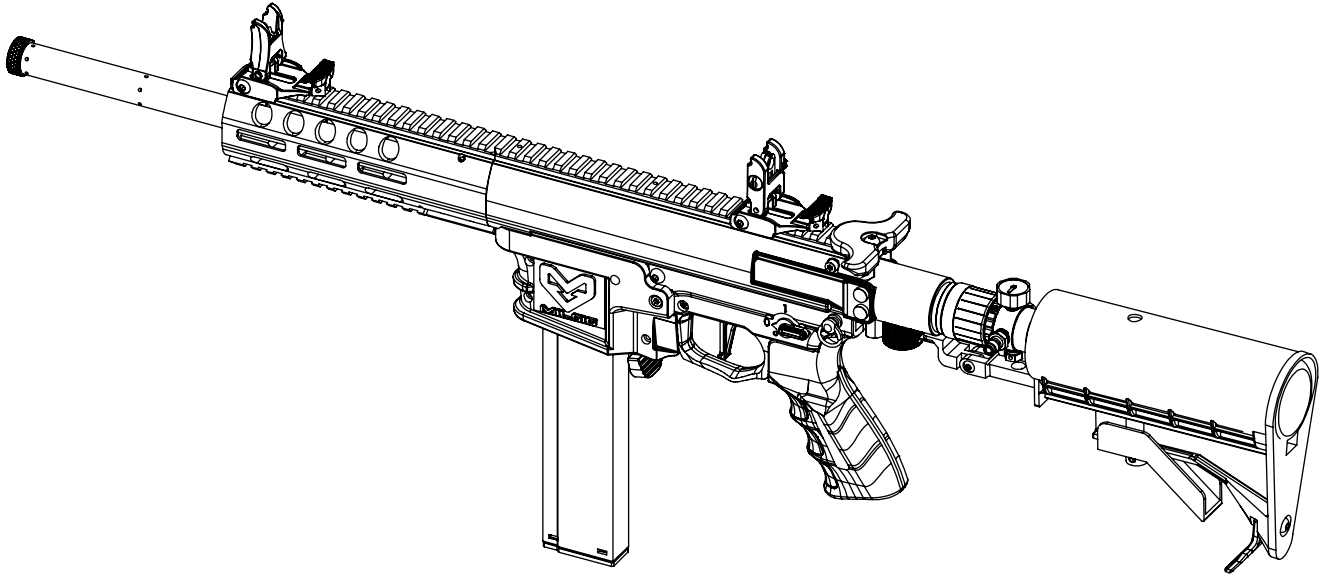

**MILSIG**

# **MILSIG Modular Blaster System**

## **MMBS**



## **INTRODUCTION**

Latest updated: June 30, 2021

**MADE IN TAIWAN**



# MMBS INSTRUCTION

## INSTRUCTIONS

1. MILSIG blaser series is design as modular system which call MMBS.
2. MMBS are construct as different parts below, STOCK, HANDGUARD, BARREL, BOLT, MAGAZINE...etc.
3. All parts belong to MMBS can be install in MMBS blaster.
4. Different part installed affect the blaster performance which include the velocity, dart/round type in the same set up of air pressure supply.

## MILSIG MODULAR BLASTER SYSTEM (MMBS)

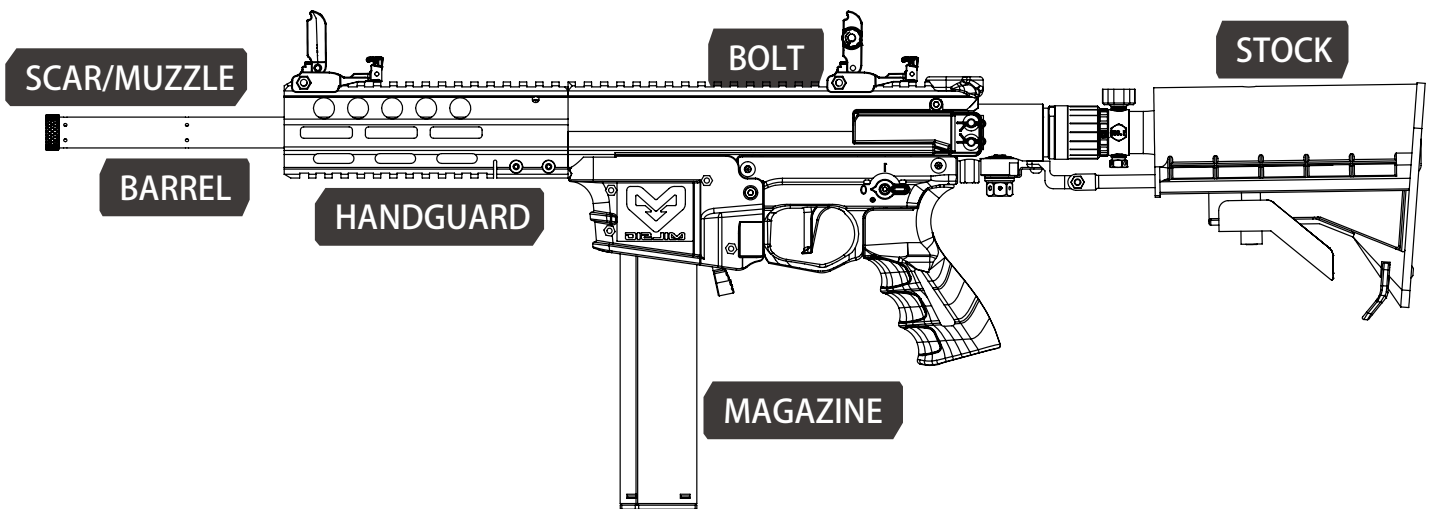

## MODULE FUNCTION

### SCAR/MUZZLE

Velocity  
Accuracy

### BARREL

Velocity  
Foam dart compatibility  
round compatibility

### HANDGUARD

Picatinny rail  
M-LOK  
Accessory install

### MAGAZINE

Half-length foam dart  
13mm round  
14.8mm round

### BOLT

universal bolt for  
Half-length foam dart and  
13mm round  
round bolt for 14.8mm round

### STOCK

Air source type  
RECOIL STABILITY



# MMBS M79 ACCESSORIES



MUZZLE

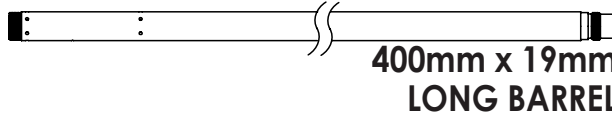

400mm x 19mm  
LONG BARREL



metal cap

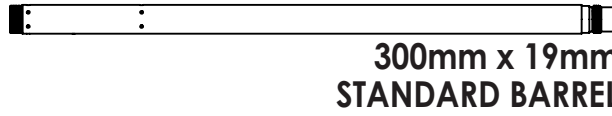

300mm x 19mm  
STANDARD BARREL



MUZZLE (ORANGE TIP)



200mm x 19mm  
SHORT BARREL

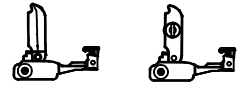

SIGHT

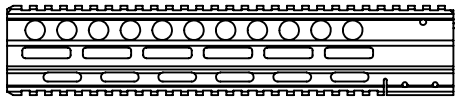

LONG HANDGUARD

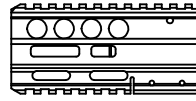

SHORT HANDGUARD

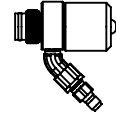

EXTERNAL HPA TANK  
CONNECTOR

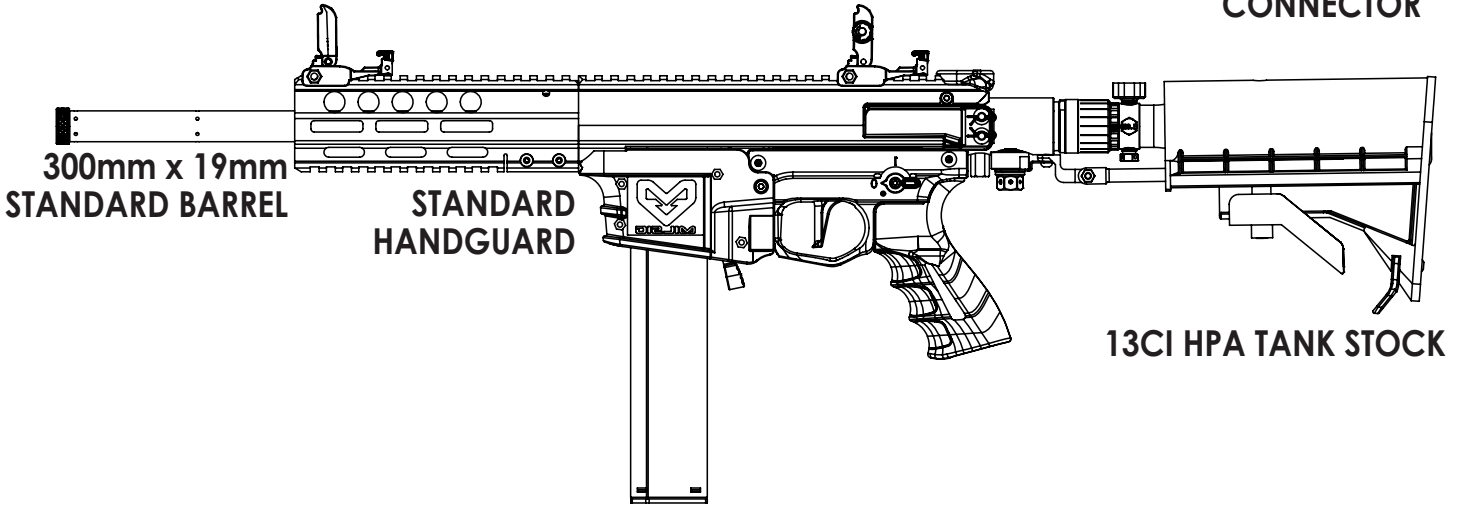

300mm x 19mm  
STANDARD BARREL

STANDARD  
HANDGUARD

13CI HPA TANK STOCK

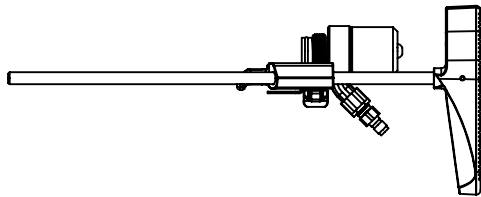

MULTI-FUNCTION STOCK

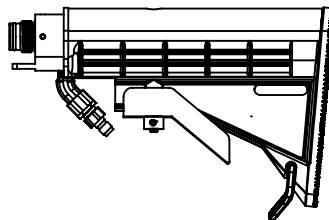

REMOTE STOCK

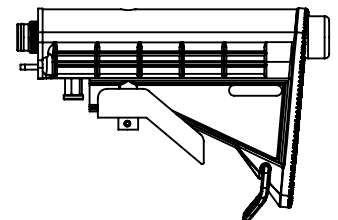

CO2 CARTRIDGE STOCK



HALF-LENGTH FOAM DART  
MAGAZINE

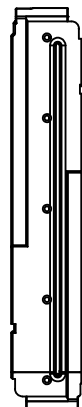

13mm ROUND  
MAGAZINE

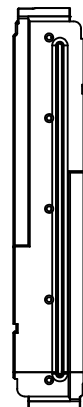

14.8 ROUND  
MAGAZINE



# MMBS CONSTRUCTIONS

## MMBS CONSTRUCTION FIGURE

METAL CAP

BARREL

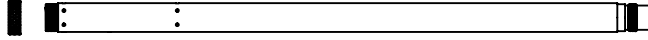

HANDGUARD

MAIN UNIT : HEAT CORE

STOCK

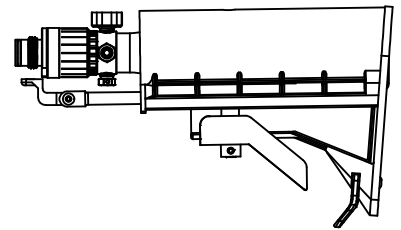
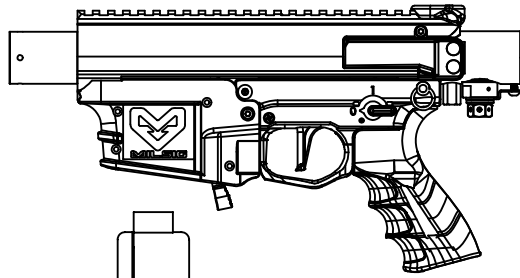
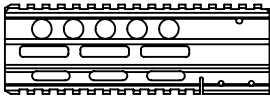

MAGAZINE

## MODULE

SCAR/MUZZLE

BARREL

HANDGUARD

METAL CAP  
MUZZLE  
GMD SCAR

200mm x 19mm short barrel  
300mm x 19mm standard barrel  
400mm x 19mm long barrel

short handguard  
standard handguard  
long handguard

MAGAZINE

BOLT

STOCK

Half-length foam dart magazine  
13mm round magazine  
14.8 round magazine

universal bolt for Half-length foam dart and 13mm round  
round bolt for 14.8 round

13CI HPA TANK STOCK  
CO2 CARTRIDGE STOCK  
REMOTE STOCK  
EXTERNAL HPA TANK CONNECTOR  
MULTI-FUNCTION STOCK



# MMBS MAIN UNIT

## HEAT CORE

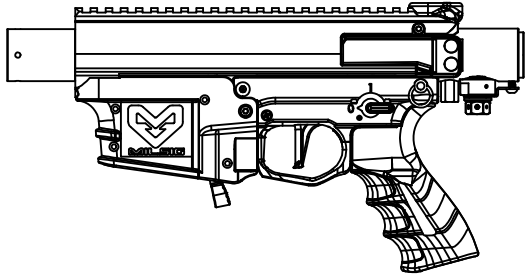

### FUNCTION

OPEN BOLT HPA CORE  
SAFETY / SEMI AUTO / FULL AUTO FIRE SELECT  
2nd stage REGULATOR = velocity adjustment

### MAXIMUM AIR PRESSURE INPUT

800psi

### MATERIAL-UPPER RECEIVER

6061-T6 ALUMINUM

### MATERIAL-MAGZAINE WELL & PISTOL GRIP

PA66 GF35 POLYAMIDE (NYLON)



# MMBS SCAR/MUZZLE

## MUZZLE (ORANGE TIP)



### FUNCTION

DECORATION

### COLOR

ORANGE

### MATERIAL

PC

## MUZZLE



### FUNCTION

DECORATION

### COLOR

BLACK

### MATERIAL

6061-T6 ALUMINUM

## GMD SCAR (20 STRING)



### FUNCTION

TWIST-RATE ADJUSTABLE  
COMPATIBLE to : foam dart / 13mm/14.8 round  
+ACCUARCY  
-VELOCITY

### MATERIAL

PVC

※ : BUILD TO ORDER



# MMBS BARREL

## 200mm x 19mm SHORT BARREL

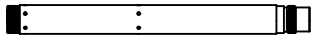

### COMMON DATA

#### MATERIAL

6061-T6 ALUMINUM

#### THREAD

M18x1.5 (BARREL install side)

M18x1 (MUZZLE install side)

#### DIAMETER

13mm (INNER)

### FUNCTION

CHAMBER of foam dart / 13mm round

PROJECTILE ACCELERATE DISTANCE

AIR SEAL BWTWEEN BARREL and PROJECTILE

### ROJECTILE TYPE

MA foam dart / 13mm round

## 300mm x 19mm STANDARD BARREL

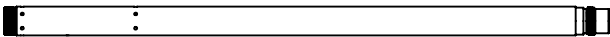

### FUNCTION

CHAMBER of foam dart / 13mm round

PROJECTILE ACCELERATE DISTANCE

AIR SEAL BWTWEEN BARREL and PROJECTILE

+VELOCITY

### ROJECTILE TYPE

MA foam dart / 13mm round

## 400mm x 19mm LONG BARREL

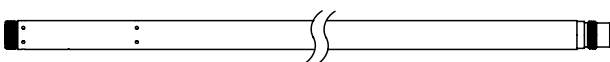

### FUNCTION

CHAMBER of foam dart / 13mm round

PROJECTILE ACCELERATE DISTANCE

AIR SEAL BWTWEEN BARREL and PROJECTILE

++VELOCITY

### ROJECTILE TYPE

MA foam dart / 13mm round

※ : BUILD TO ORDER



# MMBS HANDGUARD

## SHORT HANDGUARD

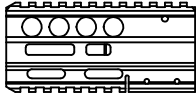

### FUNCTION

PICATINNY RAIL  
M-LOK  
ACCESSORY INSTALL

### MATERIAL

6061-T6 ALUMINUM

### COLOR (ANODIZING)

RED  
BLUE  
GOLD

## STANDARD HANDGUARD

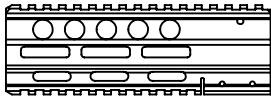

### FUNCTION

PICATINNY RAIL  
M-LOK  
ACCESSORY INSTALL

### MATERIAL

6061-T6 ALUMINUM

### COLOR (ANODIZING)

RED  
BLUE  
GOLD

## LONG HANDGUARD

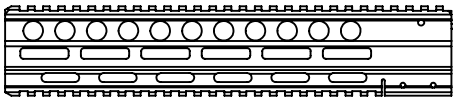

### FUNCTION

PICATINNY RAIL  
M-LOK  
ACCESSORY INSTALL

### MATERIAL

6061-T6 ALUMINUM

### COLOR (ANODIZING)

RED  
BLUE  
GOLD

※ : BUILT TO ORDER



# MMBS MAGAZINE

## HALF-LENGTH FOAM DART MAGAZINE



### FUNCTION

HALF-LENGTH FOAM DART-  
STORAGE AND FEEDING DEVICE  
SINGLE-SIDE PROJECTILE SUPPLY

## 13mm ROUND MAGAZINE



### FUNCTION

13mm ROUND PROJECTILE -  
STORAGE AND FEEDING DEVICE  
DOUBLE-SIDE PROJECTILE SUPPLY

## 14.8mm ROUND MAGAZINE



### FUNCTION

14.8mm ROUND PROJECTILE -  
STORAGE AND FEEDING DEVICE  
DOUBLE-SIDE PROJECTILE SUPPLY





# MMBS STOCK (1/2)

## 13CI HPA TANK STOCK

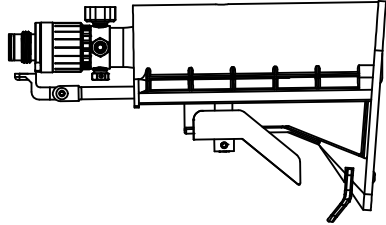

### FUNCTION

RECOIL STABILITY  
HELD AGAINST THE USER'S SHOULDER  
STOCK POSITION ADJUSTMENT  
HPA TANK CONNECT TO AIR SOURCE ADAPTOR

### POWER SOURCE

13CI HPA TANK

### FULL AUTO FUNCTION

SUPPORT

## CO2 CARTRIDGE STOCK

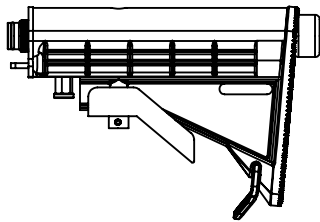

### FUNCTION

RECOIL STABILITY  
HELD AGAINST THE USER'S SHOULDER  
STOCK POSITION ADJUSTMENT

### POWER SOURCE

16G CO2 CARTRIDGE\*

### FULL AUTO FUNCTION

DO NOT SUPPORT

※ : SPEC OF 16G CO2 CARTRIDGE  
Length 88.4mm (3 1/2")  
Width 22mm (7/8")  
Neck Width 9mm (3/8")

## REMOTE STOCK

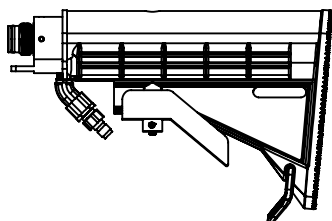

### FUNCTION

RECOIL STABILITY  
HELD AGAINST THE USER'S SHOULDER  
STOCK POSITION ADJUSTMENT  
EXTERNAL HPA TANK CONNECTABLE  
HPA TUBE CONNECTABLE (NECESSARY)

### POWER SOURCE

EXTERNAL HPA TANK

### FULL AUTO FUNCTION

SUPPORT

※ : HPA connector should be vertical type



# MMBS STOCK (2/2)

## EXTERNAL HPA TANK CONNECTOR

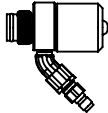

### FUNCTION

EXTERNAL HPA TANK CONNECTABLE  
HPA TUBE CONNECTABLE (NECESSARY)

### POWER SOURCE

EXTERNAL HPA TANK

### FULL AUTO FUNCTION

SUPPORT

## MULTI-FUNCTION STOCK

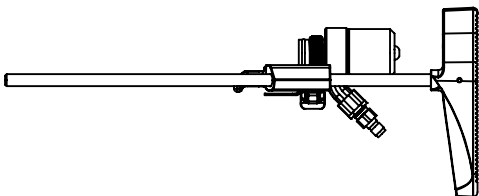

### FUNCTION

RECOIL STABILITY  
HELD AGAINST THE USER'S SHOULDER  
STOCK POSITION ADJUSTMENT  
HPA TANK CONNECT TO AIR SOURCE ADAPTOR  
EXTERNAL HPA TANK CONNECTABLE  
HPA TUBE CONNECTABLE

### POWER SOURCE

13CI HPA TANK  
EXTERNAL HPA TANK

### FULL AUTO FUNCTION

SUPPORT