

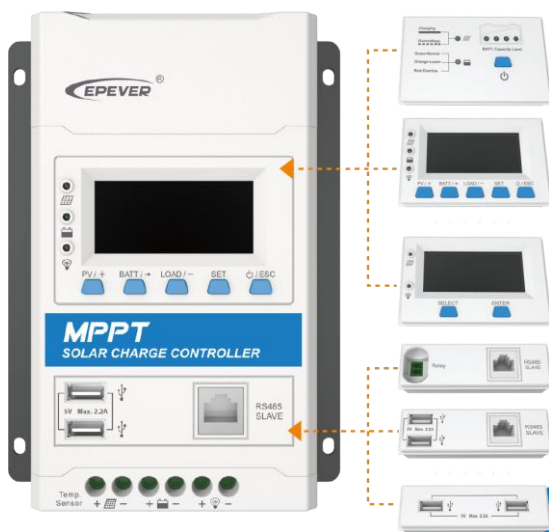

# TRIRON N Series

—Modular MPPT Solar Charge Controller

## User Manual



**Models:**

TRIRON1206N

TRIRON2206N/TRIRON1210N

TRIRON2210N/TRIRON3210N

TRIRON4210N/TRIRON4215N



# Important Safety Instructions

## Please save this manual for future review.

This manual contains safety, installation and operation for Maximum Power Point Tracking (MPPT) TRIRON N series controller ("the controller" as referred to in this manual).

## General Safety Information

- Read carefully all the instructions and warnings in the manual before installation.
- No user serviceable components inside the controller. DO NOT disassemble or attempt to repair the controller.
- Mount the controller indoors. Prevent exposure to the elements and do not allow water to enter the controller.
- Install the controller in a well ventilated -place. The controller's heat sink may become very hot during operation.
- It is suggested to install appropriate external fuses/breakers.
- Make sure to switch off all PV array connections and the battery fuse/breakers before controller installation and adjustment.
- Power connections must remain tight to avoid excessive heating from loose connection.



# CONTENTS

<b>1. General Information</b> .....	<b>1</b>
1.1 Overview.....	1
1.2 Characteristics.....	2
1.3 Module Types.....	3
1.4 Designations of Controller Models.....	6
1.5 Accessories (optional).....	7
<b>2. Installation Instructions</b> .....	<b>9</b>
2.1 General Installation Notes.....	9
2.2 PV Array Requirements.....	9
2.3 Wire Size.....	12
2.4 Mounting.....	13
<b>3. Install the modules</b> .....	<b>16</b>
<b>4. Module Introduction</b> .....	<b>18</b>
4.1 Display Module.....	18
4.1.1 Display Basic1 (DB1).....	18
4.1.2 Display Standard1 (DS1).....	19
4.1.3 Display Standard 2 (DS2).....	23
4.2 Interface modules.....	28
4.2.1 Interface type.....	28
4.2.2 Double USB (USB1).....	28
4.2.3 USB COM Slave (UCS).....	28
4.2.4 Relay COM Master (RCM).....	29
4.2.5 Relay COM Slave (RCS).....	30
<b>5. Setting Control Parameters</b> .....	<b>31</b>

5.1 Battery types . . . . .	31
5.1.1 Support battery types . . . . .	31
5.1.2 User settings. . . . .	31
5.2 Load working modes. . . . .	33
5.2.1 LCD setting. . . . .	33
5.2.2 R485 communication setting . . . . .	34
<b>6. Protections, Troubleshooting and Maintenance</b> .....	<b>37</b>
6.1 Protection . . . . .	37
6.2 Troubleshooting. . . . .	38
6.3 Maintenance . . . . .	40
<b>7. Technical Specifications</b> .....	<b>41</b>
<b>Annex I Conversion Efficiency Curves</b> .....	<b>43</b>
<b>Annex II Dimensions</b> .....	<b>49</b>

# 1. General Information

## 1.1 Overview

The TRIRON N series controllers are modular-designed products based on six MPPT solar controller models. The main unit(Power Module)(TRIRON-N) is a solar controller which can be integrated with different display and interface modules to meet a variety of functional requirements. The TRIRON N series controllers can automatically identify and load the drivers of various modules. There are three display modules (Basic 1(DB1), Standard1(DS1) and Standard2(DS2)) and four interface modules (USB COM Slave (UCS) , Relay COM Slave(RCS), Relay COM Master(RCM) and Dual USB1(USB1)). Users can choose any combination of these modules according to their needs..

With the advanced MPPT control algorithm, TRIRON N series controllers can minimize the maximum power point loss rate and loss time, quickly track the maximum power point of the PV array and obtain the maximum energy from solar modules under any conditions; and can increase the ratio of energy utilization in the solar system by 10%-30% compared with a PWM charging method. With the adaptive three-stage charging mode based on a digital control circuit, TRIRON N series controllers can effectively prolong the lifecycle of batteries, significantly improve the system performance and support all-around electronic protection functions, including overcharging and over-discharging protection to minimize damages to components of the system caused by incorrect installation or system failure at the utmost, and effectively ensure safer and more reliable operation of the solar power supply system for a longer service time. This modular solar controller can be widely used for different applications, e.g., communication base stations, household systems, street lighting systems and field monitoring, etc.

### Features:

- Identify and load the drivers of various modules automatically
- Support the hot swapping function without any damage for each module
- Modular design for easy combination and replacement
- Advanced MPPT control algorithm to minimize the maximum power point loss rate and loss time
- Advanced MPPT technology, with efficiency no less than 99.5%.
- High quality components, perfecting system performance, with maximum conversion efficiency of 98%.
- Ultra-fast tracking speed and guaranteed tracking efficiency.
- Automatic limitation of the charging power and current
- Wide MPP operating voltage range.
- Multiple load work modes

- Compatible with lead-acid and lithium-ion batteries
- Battery temperature compensation function.
- Real-time energy statistics function.
- Overheating power reduction function
- LCD and indicators to display operating data and status of the system
- User-friendly buttons for comfortable and convenient operation
- Master and slave RS485 communication modules design, reading the load or inverter operating data
- Control the inverter switch through the relay interface
- Provide 5VDC power through the dual USB output interface to charge electronic devices

## 1.2 Characteristics

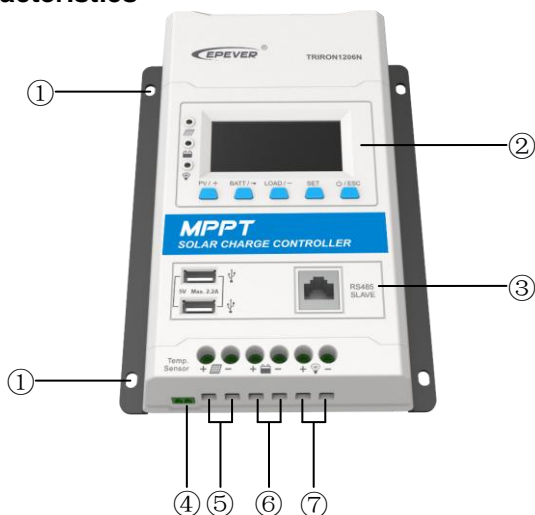

**Figure 1 Product Characteristics**

①	Mounting Hole $\Phi$ 5mm	⑤	PV Terminals
②	Display Module	⑥	Battery Terminals
③	Interface Module	⑦	Load Terminals
④	RTS* Interface		
<p>※If the temperature sensor is short-circuited or damaged, the controller will charge or discharge at the default temperature setting of 25 ° C.</p>			



## 1.3 Module Types

### ➤ 1-Power Modules



The Power Modules control PV battery charging & load discharging without any display or interface modules installed – they can operate on their own. If a display or interface module is installed, it will be powered by the Power module and the appropriate module driver will be loaded.

**NOTE: The power module can be operated independently without any other modules.**

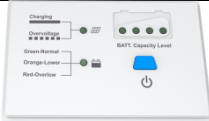

Model	System voltage	Max. PV open circuit voltage	Rated charge/discharge current	Picture
TRIRON1206N	12/24VDC	60V	10A	
TRIRON2206N	12/24VDC	60V	20A	
TRIRON1210N	12/24VDC	100V	10A	
TRIRON2210N	12/24VDC	100V	20A	
TRIRON3210N	12/24VDC	100V	30A	
TRIRON4210N	12/24VDC	100V	40A	
TRIRON4215N	12/24VDC	150V	40A	

### ➤ 2-Display Module

Module		Description	Picture
Display Basic1	DB1	<p><b>LED Indicators:</b> PV &amp; battery working status</p> <p><b>Button:</b> When the working mode is Manual Control, the load is ON/OFF via the button.</p>	

Display Standard 1	DS1	<p><b>LED Indicators:</b> PV &amp; load working status</p> <p><b>Buttons:</b> View or set the parameters</p> <p><b>LCD:</b> <i>PV display:</i> voltage/current /generated energy  <i>Battery display:</i> voltage/current/temperature  <i>Load:</i></p> <ul style="list-style-type: none"> <li>• Display current/<u>load working mode</u> when the controller communicates with the <b>PC or APP</b>.</li> <li>• Display voltage/current/ <u>power consumption</u> when the controller communicates with <b>the inverter</b>.</li> </ul>	
Display Standard 2	DS2	<p><b>Indicators:</b> PV &amp; battery &amp; load working status</p> <p><b>Buttons:</b> View or set the parameters</p> <p><b>LCD:</b> <i>PV display</i> voltage/current /generated energy/Power  <i>Battery display</i> voltage/ current/temperature/capacity  <i>Load:</i></p> <ul style="list-style-type: none"> <li>• Display voltage/ current/ power/ <u>load working mode</u> when the controller communicates with the <b>PC or APP</b>.</li> <li>• Display voltage/current/power <u>power consumption</u> when the controller communicates with <b>the inverter</b>.</li> </ul>	
No Display Cover	DCV	No indicator or display	

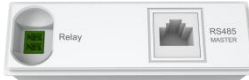
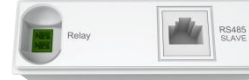
➤ **Interface Modules**

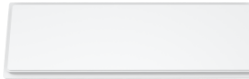
Module		Function	Picture
USB COM Slave	UCS	<p><b><u>RS485 interface:</u></b> Connect to PC or phone. View or change the controller parameters.</p> <p><b><u>USB interface:</u></b> Supplies 5VDC for electronic equipment. <b>NOTE: USB interface is output when the load is ON.</b></p>	
Relay COM Master	RCM	<p><b><u>RS485 interface:</u></b> Connect to inverter. View the inverter parameters via the LCD.</p> <p><b><u>Relay interface:</u></b> Remotely control the inverter ON/OFF.</p>	 <p><b>Accessory: 3.81-2P terminal</b></p>
Relay COM Slave	RCS	<p><b><u>RS485 interface:</u></b> Connect to PC or phone. View or change the controller parameters.</p> <p><b><u>Relay interface:</u></b> Remotely control the inverter ON/OFF.</p>	 <p><b>Accessory: 3.81-2P terminal</b></p>
Double USB	USB1	<p><b><u>USB interface:</u></b> Supplies 5VDC for electronic equipment. <b>NOTE: USB interface is output when the load is ON.</b></p>	
No COM Cover	CCV	No interface	





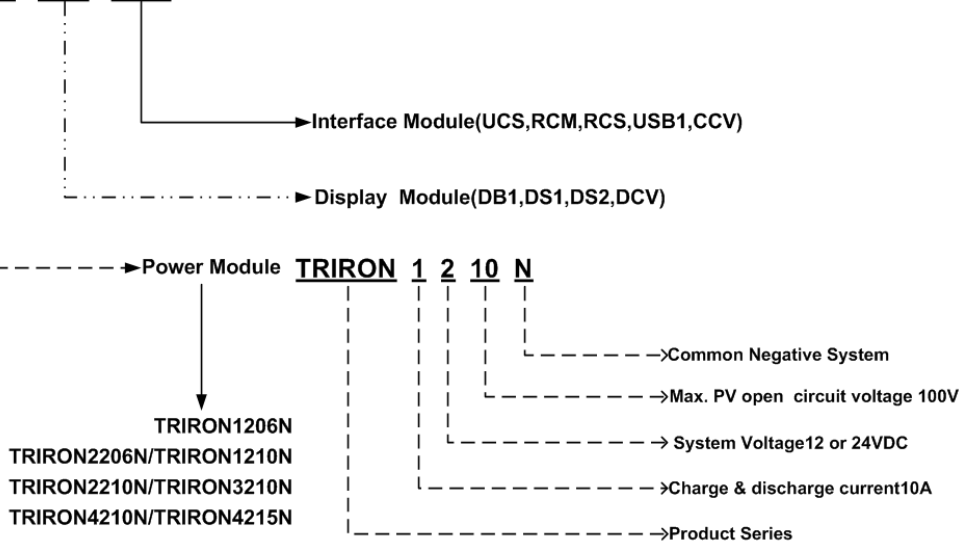

## 1.4 Designations of Controller Models

### EXAMPLE:

TRIRON1210N / DS2 / RCM



## 1.5 Accessories (optional)

<p><b>Remote Temperature Sensor</b> (RTS300R47K3.81A)</p>		<p>Acquisition of battery temperature for undertaking temperature compensation of control parameters, the standard length of the cable is 3m (length can be customized). The RTS300R47K3.81A connects to the port (4<sup>th</sup>) on the controller. <b>NOTE: The temperature sensor short-circuited or damaged, the controller will be charging or discharging at the default temperature 25 °C.</b></p>
<p><b>USB to RS485 cable</b> CC-USB-RS485-150U</p>		<p>USB to RS-485 converter is used to monitor each controller on the network using Solar Station PC software. The length of cable is 1.5m. TheCC-USB-RS485-150U connects to the RS-485 Port on the controller.</p>
<p><b>OTG cable</b> OTG-12CM</p>		<p>Used to connect a mobile communication cable and able to achieve real-time monitoring of the controller and modification of the parameters by using mobile APP software.</p>
<p><b>Remote Meter</b> MT50</p>		<p>MT50 can display various operating data and fault of the system. The information can be displayed on a backlit LCD screen, the buttons are easy-to-operate, and the numeric display is readable.</p>
<p><b>WiFi Serial Adapter</b> eBox-WIFI-01</p>		<p>After the controller is connected with the eBox-WIFI-01 through the standard Ethernet cable (parallel cable), the operating status and related parameters of the controller can be monitored by the mobile APP software through WIFI signals.</p>
<p><b>RS485 to Bluetooth Adapter</b> eBox-BLE-01</p>		<p>After the controller is connected with the eBox-BLE-01 through the standard Ethernet cable (parallel cable), the operating status and related parameters of the controller can be monitored by the mobile APP software through Bluetooth signals.</p>
<p><b>Logger</b> eLOG01</p>		<p>After the controller is connected with the eLOG-01 through the RS485 communication cable, it can record the operating data of the controller or monitor the real-time operating status of the controller via PC software.</p>
<p><b>NOTE: For setting and operation of accessory, please refer to the instructions.</b></p>		

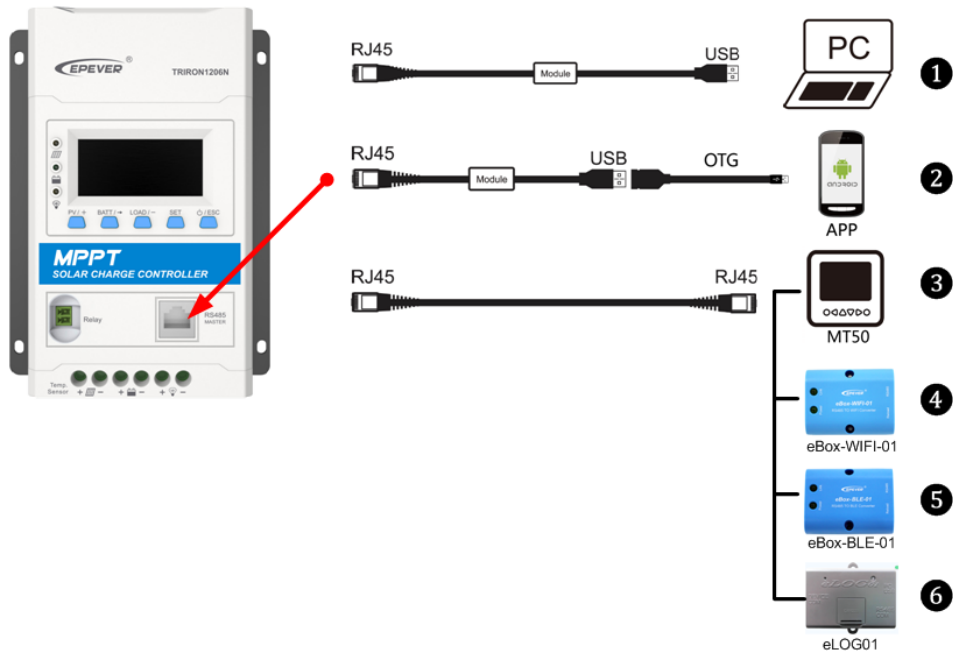

## 2. Installation Instructions

### 2.1 General Installation Notes

- Please read the entire installation instructions to get familiar with the installation steps before installation.
- Be very careful when installing the batteries, especially flooded lead-acid battery. Please wear eye protection, and have fresh water available to wash and clean any contact with battery acid.
- Keep the battery away from any metal objects, which may cause short circuit of the battery.
- Explosive battery gases may come out from the battery during charging, so make sure ventilation condition is good.
- Ventilation is highly recommended if mounted in an enclosure. Never install the controller in a sealed enclosure with flooded batteries! Battery fumes from vented batteries will corrode and destroy the controller circuits.
- Loose power connections and corroded wires may result in high heat that can melt wire insulation, burn surrounding materials, or even cause fire. Ensure tight connections and use cable clamps to secure cables and prevent them from swaying in mobile applications.
- Lead-acid battery and lithium battery are recommended, other kinds please refer to the battery manufacturer.
- Battery connection may be wired to one battery or a bank of batteries. The following instructions refer to a singular battery, but it is implied that the battery connection can be made to either one battery or a group of batteries in a battery bank.
- Multiple same models of controllers can be installed in parallel on the same battery bank to achieve higher charging current. Each controller must have its own solar module(s).
- Select the system cables according to  $5A/mm^2$  or less current density in accordance with Article 690 of the National Electrical Code, NFPA 70.

### 2.2 PV Array Requirements

#### (1) Serial connection (string) of PV modules

As the core component of PV system, controller could be suitable for various types of PV modules and maximize converting solar energy into electrical energy. According to the open circuit voltage ( $V_{oc}$ ) and the maximum power point voltage ( $V_{MPP}$ ) of the MPPT controller, the series number of different types PV modules can be calculated. The below table is for reference only.

**TRIRON1206N/2206N:**

System voltage	36 cell Voc<23V		48 cell Voc<31V		54 cell Voc<34V		60 cell Voc<38V	
	Max.	Best	Max.	Best	Max.	Best	Max.	Best
12V	2	2	1	1	1	1	1	1
24V	2	2	-	-	-	-	-	-

System voltage	72 cell Voc<46V		96 cell Voc<62V		Thin-Film Module Voc>80V
	Max.	Best	Max.	Best	
12V	1	1	-	-	-
24V	1	1	-	-	-

**NOTE:** The above parameter values are calculated under standard test conditions (STC (Standard Test Condition): Irradiance 1000W/m<sup>2</sup>, Module Temperature 25°C, Air Mass1.5.)

**TRIRON1210N/2210N/3210N/4210N:**

System voltage	36 cell Voc<23V		48 cell Voc<31V		54 cell Voc<34V		60 cell Voc<38V	
	Max.	Best	Max.	Best	Max.	Best	Max.	Best
12V	4	2	2	1	2	1	2	1
24V	4	3	2	2	2	2	2	2

System voltage	72 cell Voc<46V		96 cell Voc<62V		Thin-Film Module Voc>80V
	Max.	Best	Max.	Best	
12V	2	1	1	1	1
24V	2	1	1	1	1

**NOTE:** The above parameter values are calculated under standard test conditions (STC (Standard Test Condition): Irradiance 1000W/m<sup>2</sup>, Module Temperature 25°C, Air Mass1.5.)

**TRIRON4215N:**

System voltage	36cell Voc<23V		48cell Voc<31V		54cell Voc<34V		60cell Voc<38V	
	Max.	Best	Max.	Best	Max.	Best	Max.	Best
12V	4	2	2	1	2	1	2	1
24V	6	3	4	2	4	2	3	2

System voltage	72cell Voc<46V		96cell Voc<62V		Thin-Film Module Voc>80V
	Max.	Best	Max.	Best	
12V	2	1	1	1	1
24V	3	2	2	1	1

**NOTE:** The above parameter values are calculated under standard test conditions (STC (Standard Test Condition): Irradiance 1000W/m<sup>2</sup>, Module Temperature 25°C, Air Mass1.5.)



## (2) Maximum PV array power

This MPPT controller has a limiting function of charging current/power. The charging current/power will be limited within the rated range, therefore, the controller will charge the battery with the rated charging power even if the input power at the PV exceeds this limit.

The actual operation power of the PV array conforms to the conditions below:

- 1) PV array actual power  $\leq$  controller rated charge power, the controller will charge the battery at the actual maximum power point.
- 2) PV array actual power  $>$  controller rated charge power, the controller will charge the battery at the charger's maximum rated power.

If the PV power is higher than the charger's maximum rated power, the charging time at rated power to the battery will be longer, and more energy to battery will be stored in the battery..



### WARNING:

The controller has a maximum PV power input rating(watts), and will allow the PV power to be higher than the rated power, but if the PV power is three times greater than the rated power, the controller will be damaged.



### WARNING:

If the PV array is reverse connected to the controller, 1.5 times rated power(watts) will damage the controller.

When sizing a PV array to a charge controller, be sure to choose PV panels that when combined(or singly), will not exceed the controller's maximum input current rating(Isc) and open circuit voltage rating(Voc), in addition to the power limitation noted above! Please refer to the table below:

Model	Rated Charge Current	Rated Charge Power	Max. PV Array Power	Max. PV open circuit voltage
TRIRON1206N	10A	130W/12V 260W/24V	390W/12V 780W/24V	46V <sup>①</sup>
TRIRON2206N	20A	260W/12V 520W/24V	780W/12V 1560W/24V	60V <sup>②</sup>
TRIRON1210N	10A	130W/12V 260W/24V	390W/12V 780W/24V	92V <sup>①</sup> 100V <sup>②</sup>
TRIRON2210N	20A	260W/12V 520W/24V	780W/12V 1560W/24V	
TRIRON3210N	30A	390W/12V 780W/24V	1170W/12V 2340W/24V	
TRIRON4210N	40A	520W/12V 1040W/24V	1560W/12V 3120W/24V	138V <sup>①</sup> 150V <sup>②</sup>
TRIRON4215N	40A	520W/12V 1040W/24V	1560W/12V 3120W/24V	

①At 25°C environment temperature

②At minimum operating environment temperature



**WARNING:** The controller may be damaged when the maximum PV open circuit voltage(Voc) exceeds 60V(TRIRON\*\*06N), 100V(TRIRON\*\*10N) or 150V (TRIRON\*\*15N) at minimum operating environment temperature.

## 2.3 Wire Size

The wiring and installation methods must conform to all national and local electrical code requirements.

### ➤ PV Wire Size

Since PV array output can vary due to the PV module size, connection method or sunlight angle, the minimum wire size can be calculated by the  $I_{sc}^*$  of PV array. Please refer to the value of  $I_{sc}$  in the PV module specification. When PV modules connect in series, the  $I_{sc}$  is equal to a PV modules  $I_{sc}$ . When PV modules connect in parallel, the  $I_{sc}$  is equal to the sum of the PV module' s  $I_{sc}$ . The  $I_{sc}$  of the PV array must not exceed the controller' s maximum PV input current. Please refer to the table as below:

NOTE: All PV modules in a given array are assumed to be identical.

\*  $I_{sc}$ =short circuit current(amps) Voc=open circuit voltage.

Model	Max. PV input current	Max. PV wire size*
TRIRON1206N TRIRON1210N	10A	4mm <sup>2</sup> /12AWG
TRIRON2206N TRIRON2210N	20A	6mm <sup>2</sup> /10AWG
TRIRON3210N	30A	10mm <sup>2</sup> /8AWG
TRIRON4210N TRIRON4215N	40A	16mm <sup>2</sup> /6AWG

\* These are the maximum wire sizes that will fit the controller terminals.



**NOTE:** When the PV modules connect in series, the open circuit voltage of the PV array must not exceed 46V (TRIRON\*\*06N), 92V (TRIRON\*\*10N) or 92V (TRIRON\*\*15N) at 25°C environment temperature.

### ➤ Battery and Load Wire Size

The battery and load wire size must conform to the rated current, the reference size as below:

Model	Rated charge current	Rated discharge current	Battery wire size	Load wire size
TRIRON1206N TRIRON1210N	10A	10A	4mm <sup>2</sup> /12AWG	4mm <sup>2</sup> /12AWG
TRIRON2206N TRIRON2210N	20A	20A	6mm <sup>2</sup> /10AWG	6mm <sup>2</sup> /10AWG
TRIRON3210N	30A	30A	10mm <sup>2</sup> /8AWG	10mm <sup>2</sup> /8AWG
TRIRON4210N TRIRON4215N	40A	40A	16mm <sup>2</sup> /6AWG	16mm <sup>2</sup> /6AWG



**NOTE:** The wire size is only for reference. If there is a long distance between the PV array and the controller or between the controller and the battery, larger wires can be used to reduce the voltage drop and improve performance.

## 2.4 Mounting



**WARNING:** Risk of explosion! Never install the controller in a sealed enclosure with flooded batteries! Do not install in a confined area where battery gas can accumulate.



**WARNING:** Risk of electric shock! When wiring the solar modules, the PV array can produce open circuit voltages in excess of 100V when in sunlight.



**NOTE:** The controller requires at least 150mm of clearance above and below for proper air flow. Ventilation is highly recommended if mounted in an enclosure.

### Installation Procedure:

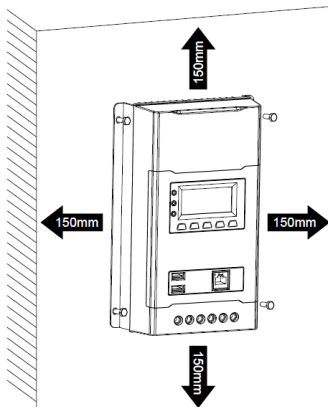

Figure2-1 Mounting

## Step 1: Determination of Installation Location and Heat-dissipation Space

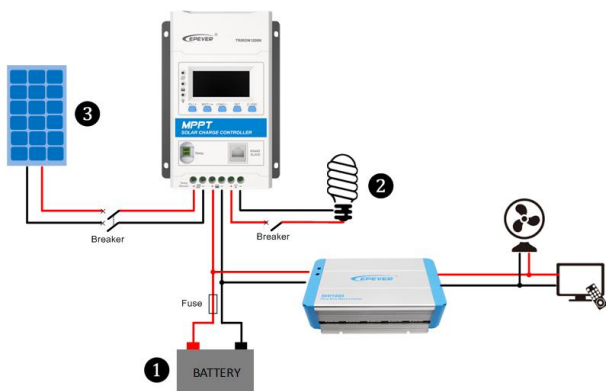

Figure 2-2 Schematic of wiring diagram

Determination of installation location: The controller shall be installed in a place with sufficient air flow through the radiators of the controller and a minimum clearance of 150 mm from the upper and lower edges of the controller to ensure natural thermal convection. Please see Figure 2-1: Mounting



**NOTE:** If the controller is to be installed in an enclosed box, it is important to ensure reliable heat dissipation through the box.

**Step 2:** Connect the system in the order of ① battery → ② load → ③ PV array in accordance with Figure 2-2, "Schematic Wiring Diagram" and disconnect the system in the reverse order ③ ② ①.



**NOTE:** While wiring the controller do not close the circuit breaker or fuse and make sure that the leads of "+" and "-" poles are connected correctly.



**NOTE:** A fuse which current is 1.25 to 2 times the rated current of the controller must be installed on the battery side with a distance from the battery not greater than 150 mm.



**NOTE:** If an inverter is to be connected to the system, connect the inverter directly to the battery, not to the load side of the controller.

### Step 3: Grounding

As the TRIRONN series is a common negative controller, the negative poles of the PV array, battery and load can be grounded together.



**NOTE:** The controller can also be used in a common positive system. In this case, the negative poles of the controller, PV and load can't be grounded together, but only one of them can be grounded.

#### Step 4: Connect accessories

- Connect the remote temperature sensor cable (model: RTS300R47K3.81A)

Connect one end of the remote temperature sensor cable to the interface ③ and place the other end close to the battery.

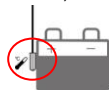

**NOTE:** If the remote temperature sensor is not connected to the controller,, the default setting for battery charging or discharging temperature is 25 °C without temperature compensation.

- Connect the accessories for RS485 communication

Refer to 3.2 “Setting and Operation of Controller”



**NOTE:** The RS-485 port is not SELV circuit, it must have isolation between the port and the place where the end user can access directly.

#### Step 5: Powered on the controller

Closing the battery fuse will switch on the controller. Then check the status of the battery indicator (the controller is operating normally when the indicator is lit in green). Close the fuse and circuit breaker of the load and PV array. Then the system will be operating in the preprogrammed mode.



**NOTE:** If the controller is not operating properly or the battery indicator on the controller shows an abnormality, please refer to 4.2 “Troubleshooting”.

### 3. Install the modules

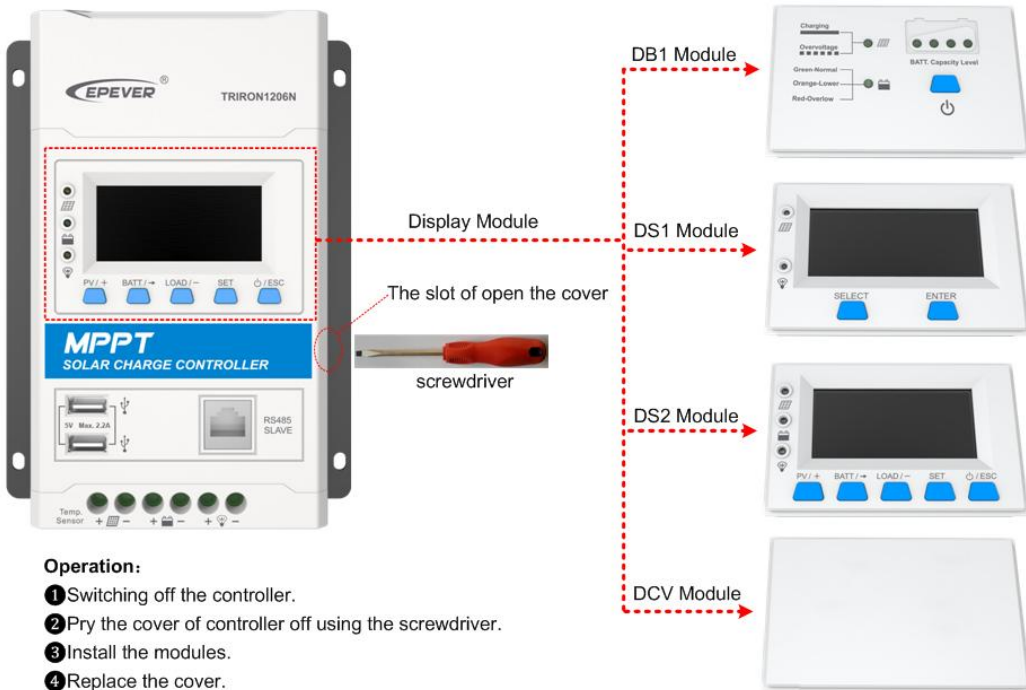

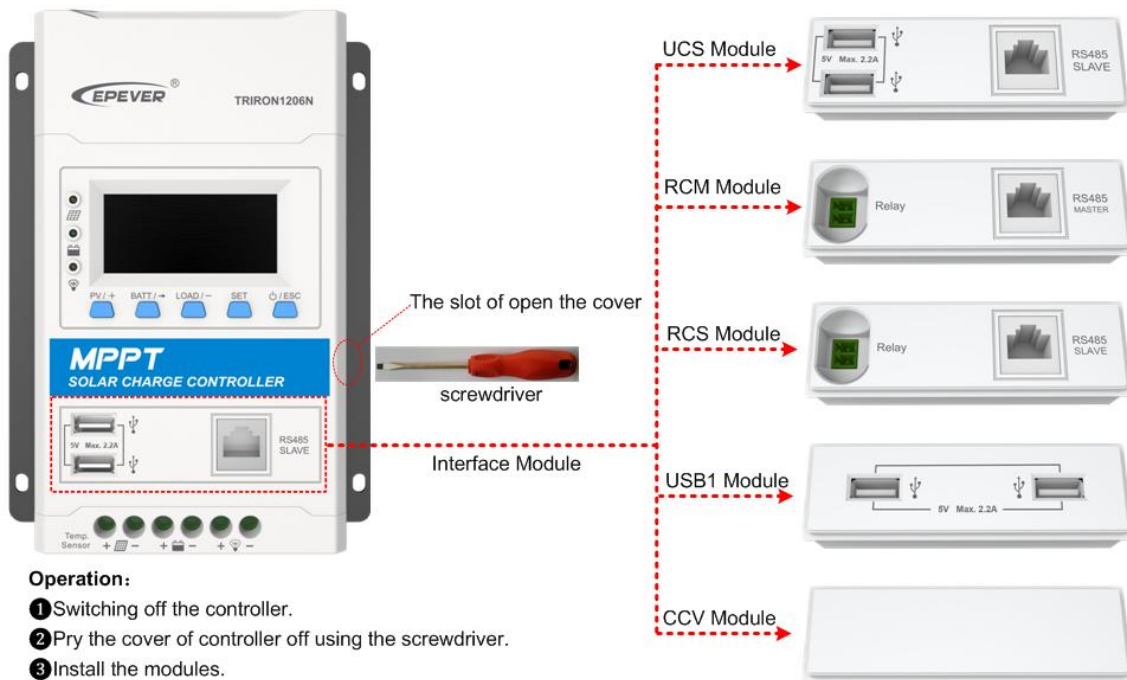

**Operation:**

- 1 Switching off the controller.
- 2 Pry the cover of controller off using the screwdriver.
- 3 Install the modules.
- 4 Replace the cover.
- 5 Power on the controller.



# 4. Module Introduction

## 4.1 Display Module

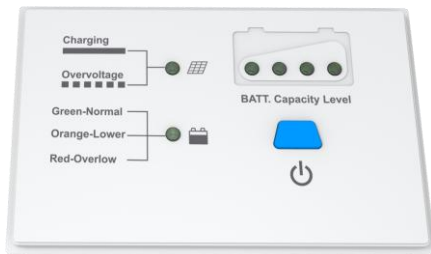
### 4.1.1 Display Basic1 (DB1)



#### (1) Charging and battery LED indicator

Indicator	Color	Status	Information
	Green	On Solid	PV connection normal ,but low voltage(low irradiance) from PV, no charging
	Green	OFF	No PV voltage(night time) or PV connection problem
	Green	Slowly Flashing(1Hz)	In charging
	Green	Fast Flashing(4Hz)	PV Over voltage
	Green	On Solid	Normal
	Green	Slowly Flashing(1Hz)	Full
	Green	Fast Flashing(4Hz)	Over voltage
	Orange	On Solid	Under voltage
	Red	On Solid	Over discharged
	Red	Slowly Flashing(1Hz)	Battery Overheating Low temperature <sup>①</sup>
All LED indicators fast flashing at the same time			System voltage error <sup>②</sup> Controller Overheating

①When a lead-acid battery is used, the controller hasn't the low temperature protection.

②When a lithium-ion battery is used, the system voltage can't be identified automatically.



## (2) Battery Capacity Level Indicator

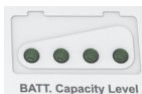

### ● Battery Capacity Level (BCL)

Indicator	Color	Status	Information
☆○○○	Green	25% Indicator slowly flashing	0%to <25%
●☆○○	Green	50% Indicator slowly flashing 25% Indicator on solid	25%to <50%
●●☆○	Green	75% Indicator slowly flashing 25%,50% Indicators on solid	50%to <75%
●●●☆	Green	100% Indicator slowly flashing 25%,50%,75% Indicators on solid	75% to 100%
●●●●	Green	25%,50%,75%,100%Indicators on solid	100%

“○” Indicator is OFF; “●”Indicator is on Solid; “☆” Indicator is slowly flashing.

### ● Load status

Battery Capacity Level	Green	on solid	The load is ON
	Green	OFF	The load is OFF

## (3) Button





In the manual mode of the load, it can control On/Off of the load via the button.







### 4.1.2 Display Standard1 (DS1)



## (1) Charging and load LED indicator

Indicator	Color	Status	Instruction
	Green	On Solid	PV connection normal but low voltage(low irradiance) from PV, no charging
	Green	OFF	No PV voltage(night time) or PV connection problem
	Green	Slowly Flashing(1Hz)	Charging Battery
	Green	Fast Flashing(4Hz)	PV Over voltage
	Red	On Solid	Load ON
	Red	OFF	Load OFF



## (2) Button



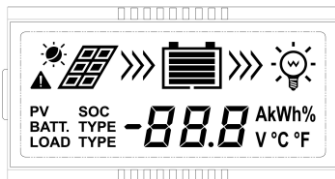

Mode	Note
Load ON/OFF	In load manual mode, it can turn the load On/Off of the load via the  button.
Clear Fault	Press the  button
Browsing Mode	Press the  button
Setting Mode	Press the  button and hold on 5s to enter the setting mode
	Press the  button to set the parameters,
	Press the  button to confirm the setting parameters or exit the setting mode automatically after 10s.

## (3) Interface



### 1) Icon

Item	Icon	Status
PV array		Day
		Night

		No charging
		Charging
	<b>PV</b>	PV Voltage, Current, Power
Battery		Battery capacity, In Charging
	<b>BATT.</b>	Battery Voltage, Current, Temperature
	<b>BATT. TYPE</b>	Battery Type
Load		Load ON
		Load OFF
	<b>LOAD</b>	Load Voltage, Current, Load mode

## 2) Browse interface

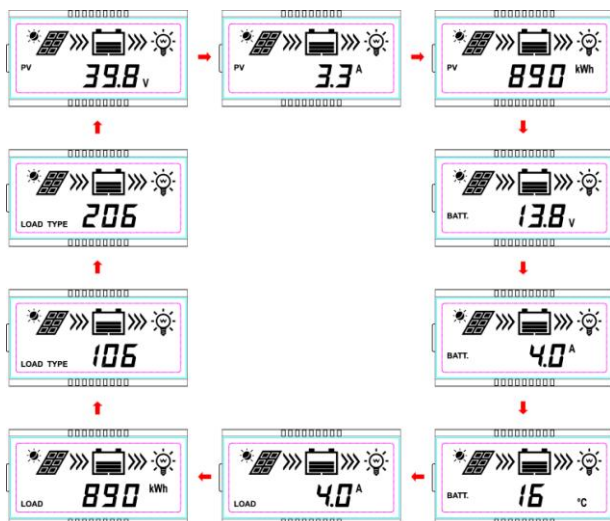

## 3) Load parameters

- Combination of the DS1 and RCM modules (To connect the system with the inverter, refer to 4.3.2)



Display: Voltage/Current/Consumed power

- **Combination of the DS2 and UCS modules with the LCD display (connect a LED load: refer to 4.3.2)**

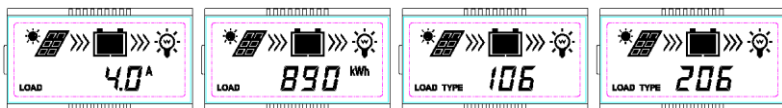



Display: Current/Consumed power/Load working mode-Timer1/ Load working mode-Timer2

#### 4) Setting

##### ① Clear the generated energy

Operating:

**Step 1:** Press the  button and hold 5s under the PV power interface and the value is flashing.

**Step 2:** Press the  button to clear the generated energy..

##### ② Switch the battery temperature unit

Press the  button and hold 5s under the battery temperature interface.

##### ③ Battery type

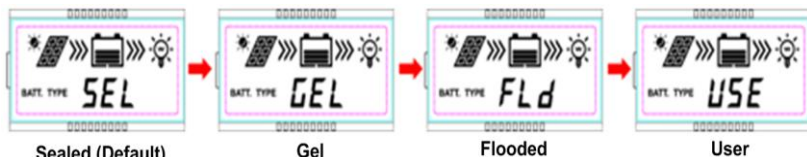

Sealed (Default)

Gel

Flooded

User

Operating:

**Step 1:** Press the  button and hold 5s under the battery voltage interface.

**Step 2:** Press the  button when the battery type interface is flashing.

**Step 3:** Press the  button to confirm the battery type.



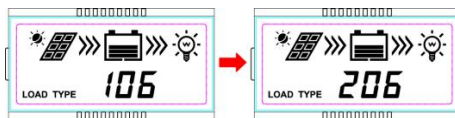

**NOTE:** Please refer to chapter 5.1 for the battery control voltage, when the battery type is User.

#### ④ Local load mode



**Operating:**

**Step1:** Press the  button and hold 5s under the load mode interface.

**Step2:** Press the  button when the load mode interface is flashing.



**Step3:** Press the  button to the load mode.

**NOTE:** Please refer to 5.2 for the load working modes.

### 4.1.3 Display Standard 2 (DS2)



#### (1) Indicator





Indicator	Color	Status	Instruction
	Green	On Solid	PV connection normal but low voltage(low irradianc) from PV, no charging
	Green	OFF	No PV voltage(night time) or PV connection problem
	Green	Slowly Flashing(1Hz)	Charge Battery
	Green	Fast Flashing(4Hz)	PV Over voltage
	Green	On Solid	Normal
	Green	Slowly Flashing(1Hz)	Full
	Green	Fast Flashing(4Hz)	Over voltage
	Orange	On Solid	Under voltage

	Red	On Solid	Over discharged
	Red	Slowly Flashing(1Hz)	Battery Overheating Low temperature <sup>①</sup>
	Yellow	On Solid	Load ON
	Yellow	OFF	Load OFF
PV&BATLED fast flashing			Controller Overheating System voltage error <sup>②</sup>

①When a lead-acid battery is used, the controller hasn't the low temperature protection.





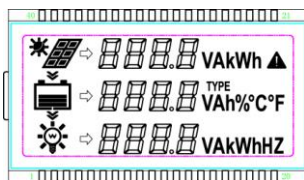

②When a lithium-ion battery is used, the system voltage can't be identified automatically.

## (2)Button

	Press the button	PV browsing interface
		Setting data +
	Press the button and hold 5s	Setting the LCD cycle time
	Press the button	BATT browsing interface
		Cursor displacement during setting
	Press the button and hold 5s	Setting the battery type, battery capacity level and temperature unit.
	Press the button	1.Inverter load browsing interface with RCM module 2.Controller load browsing interface with RCS module.
		Setting data -
	Press the button and hold 5s	Setting the load working mode with RCS module.
	Press the button	Setting interface
		Setting interface switch to the browsing interface
		Setting parameter to enter button
	Press the button	Turn ON/OFF the inverter with RCS module
		Exit the setting interface

## (3)Display



Icon	Information	Icon	Information	Icon	Information
	Day		Not charging		Not discharging
	Night		Charging		Discharging

### 1) PV parameters

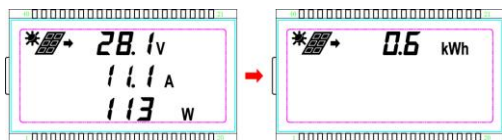

Display: Voltage/Current/Power/Generated Energy

### 2) Battery parameters

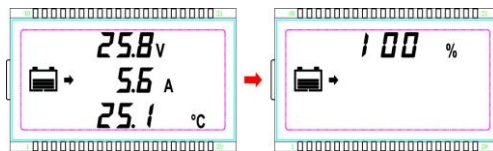

Display: Voltage/Current/Temperature/Battery capacity level

### 3) Load parameters

- Combination of the DS2 and RCM modules (To connect the system with the inverter, refer to 4.3.2)

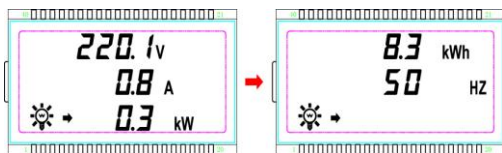

Display: Voltage/Current/Power/ Consumed energy/Frequency

- Combination of the DS2 and UCS modules with the LCD display (connect a LED load: refer to 4.3.2)

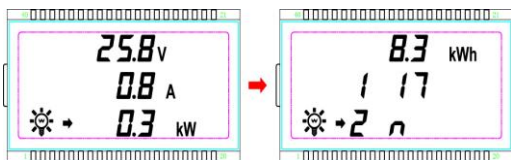

Display: Voltage/Current/Power/ Consumed energy/Load working mode-Timer1/ Load working mode-Timer2

## (4) Setting parameters

### 1) Battery type

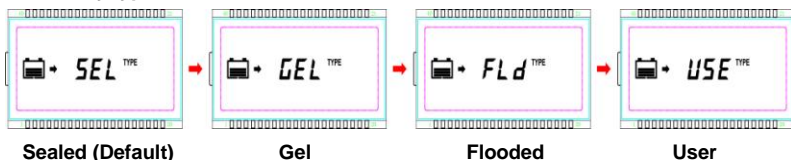

**Operation:**

**Step 1:** Press the  button for the setting interface.

**Step 2:** Press the  button and hold 5s the battery type interface.

**Step 3:** Press the  or  button to choose the battery type.

**Step 4:** Press the  button to confirm the battery type.



**NOTE:** Please refer to chapter 5.1 for the battery control voltage, when the battery type is User.

### 2) Battery capacity



**Operation:**

**Step 1:** Press the  button for the setting interface.

**Step 2:** Press the  button and hold 5s for the battery type interface.

**Step 3:** Press the  button for the battery capacity interface.

**Step 4:** Press the  or  button to set the battery capacity.



**Step 5:** Press the  button to confirm the parameters.

### 3) Temperature unit

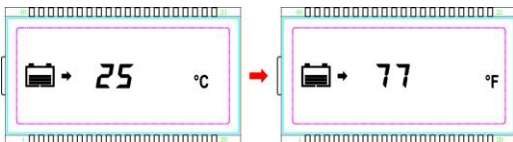

**Operation:**

**Step 1:** Press the  button for the setting interface.

**Step 2:** Press the  button and hold 5s for the battery type interface.

**Step 3:** Press the  button twice for the temperature units interface.

**Step 4:** Press the  or  button to set the temperature units.

**Step 5:** Press the  button to confirm the parameters.

### 4) LCD cycle time

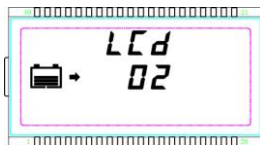

**NOTE:** The LCD cycle default time is 2s, the setting time range is 0~20s.

**Operation:**

**Step 1:** Press the  button for the setting interface.

**Step 2:** Press the  button and hold 5s for the LCD cycle time interface.



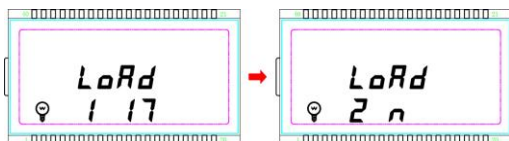

**Step 3:** Press the  or  button to set the LCD cycle time.

**Step 4:** Press the  button to confirm the parameters.

### 5) Local load working mode with the RCS module



**Operation:**

- Step 1:** Press the  button for the setting interface.
- Step 2:** Press the  button and hold 5s for the load working mode interface.
- Step 3:** Press the  or  button to set the working mode..
- Step 4:** Press the  button to confirm the parameters.
- NOTE:** Please refer to chapter 5.2 for the load working mode.

## 4.2 Interface modules

### 4.2.1 Interface type

Interface	Interface type	Output voltage/current	Short circuit protection
USB output interface	Standard USB	5VDC/2.2A(Total)	Yes
RS485 com. interface	RJ45	5VDC/100mA	Yes
Relay interface	3.81-2P	30VDC/1A	NO

### 4.2.2 Double USB (USB1)

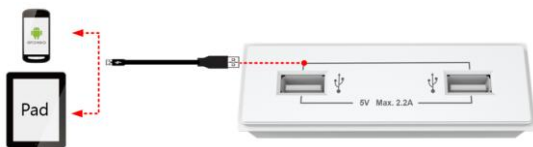

#### USB output interface:

Charging for phone, pad and so on. Max. charging current is 2.2A(total).

NOTE: USB interface output voltage/current available when the load is ON.

### 4.2.3 USB COM Slave (UCS)



USB output interface: Charging for phone, pad and so on. Max. charging current is 2.2A(total). NOTE: USB interface output voltage/current available when the load is ON.

RS485 interface: View working status and view/modify working parameters via APP or PC software.

#### 4.2.4 Relay COM Master (RCM)

**RS485 interface:** When the master is set in RS485 communication mode, i.e., with a combination of the RCM and DS1/DS2 modules, the information of the inverter (to be supplied by our company) can be displayed by the DS1/DS2 module. See the following figure:

**Relay interface:** It shall connect the controller's relay in parallel with the inverter start switch, so it can turn ON/OFF the inverter by operating the button.

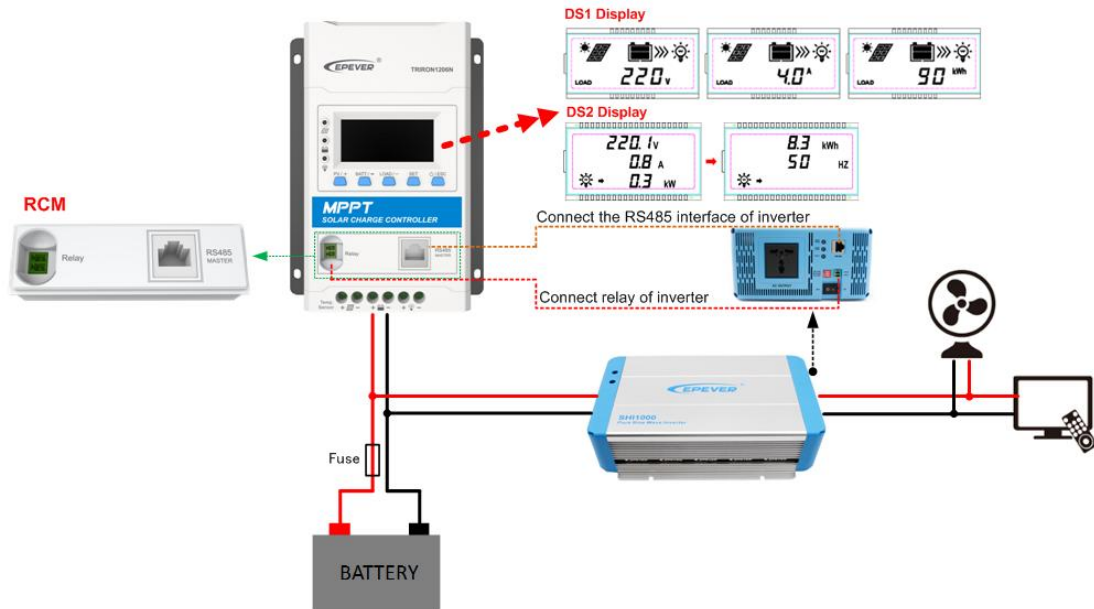

## 4.2.5 Relay COM Slave (RCS)

**RS485 interface:** When the slave is set in RS485 communication mode, i.e., with a combination of the RCS and DS1/DS2 modules, the information of the inverter (to be supplied by our company) can be displayed by the DS1/DS2 module.

**Relay interface:** It shall connect the controller's relay in parallel with the inverter start switch, so it can turn ON/OFF the inverter by operating the button.

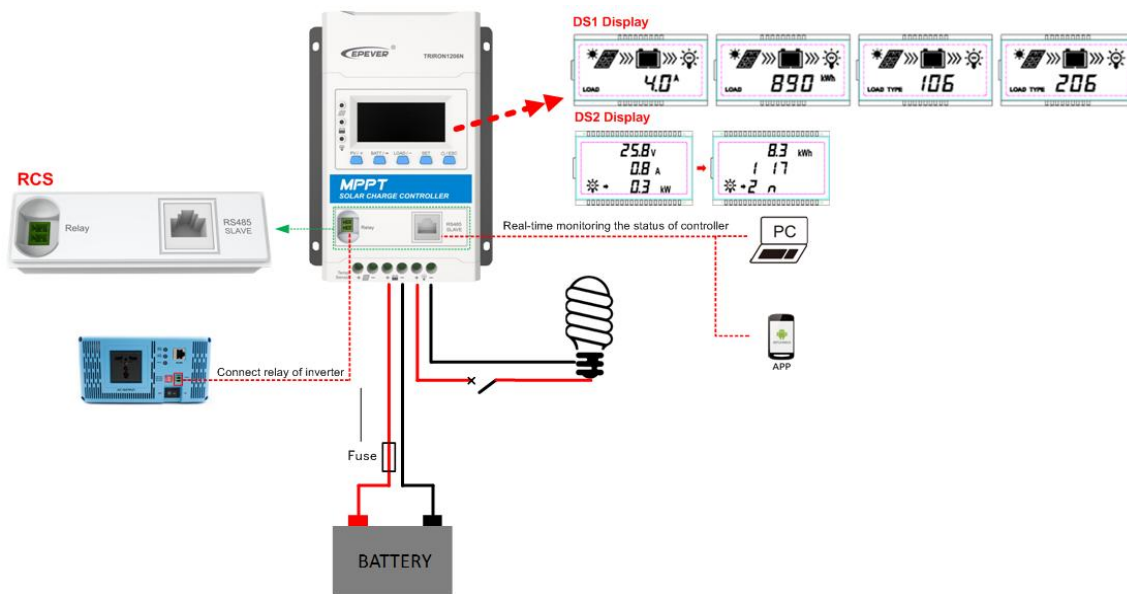

## 5. Setting Control Parameters

### 5.1 Battery types

#### 5.1.1 Support battery types

Item	Lead-acid battery	Lithium battery
1	Sealed(default)	LiFePO <sub>4</sub> (4s/12V; 8s/24V)
2	Gel	Li(NiCoMn)O <sub>2</sub> (3s/12V; 6s/24V)
3	Flooded	User (9~34V)
4	User(9~17V/12V; 18~34V/24V)	



**NOTE:** When the default battery type is selected, the battery voltage control parameters will be set by default and can't be changed. To change these parameters, select "User" battery type..

#### 5.1.2 Battery Voltage Control Parameters

Below parameters are in 12V system at 25 °C, please double the values in 24V system

Battery type	Sealed	Gel	Flooded	User
<b>Voltage</b>				
Over Voltage Disconnect Voltage	16.0V	16.0V	16.0V	9~17V
Charging Limit Voltage	15.0V	15.0V	15.0V	9~17V
Over Voltage Reconnect Voltage	15.0V	15.0V	15.0V	9~17V
Equalize Charging Voltage	14.6V	—	14.8V	9~17V
Boost Charging Voltage	14.4V	14.2V	14.6V	9~17V
Float Charging Voltage	13.8V	13.8V	13.8V	9~17V
Boost Reconnect Charging Voltage	13.2V	13.2V	13.2V	9~17V
Low Voltage Reconnect Voltage	12.6V	12.6V	12.6V	9~17V
Under Voltage Warning Reconnect Voltage	12.2V	12.2V	12.2V	9~17V
Under Voltage Warning Voltage	12.0V	12.0V	12.0V	9~17V
Low Voltage Disconnect Voltage	11.1V	11.1V	11.1V	9~17V
Discharging Limit Voltage	10.6V	10.6V	10.6V	9~17V
Equalize Duration	120 min	—	120 min	0~180 min
Boost Duration	120 min	120 min	120 min	10~180 min



**NOTE:** Due to diversification of lithium battery types, its control voltage shall be confirmed with the engineer.

### 5.1.3 User settings

- 1) PC setting
- Connection

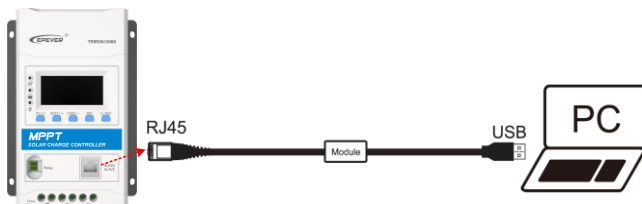

- Download software  
<http://www.epever.com> (PC Software for the Solar Charge Controller)

- 2) APP software setting

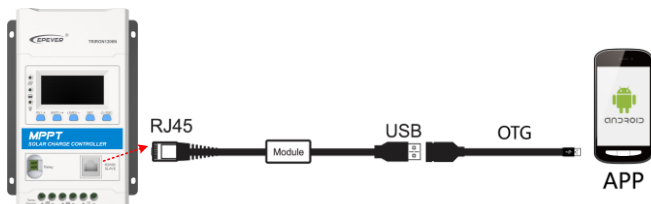

- Download software(User for lead-acid battery)  
<http://www.epever.com> (Android APP for the Solar Charge Controller)
- Download software(User for lithium battery)  
<http://www.epever.com> (Android APP for the Li-Battery Solar Charge Controller)

- 3) Setting the control voltage value

- The following rules must be observed when modifying the parameters value in User for lead-acid battery.

I. Over Voltage Disconnect Voltage > Charging Limit Voltage ≥ Equalize Charging Voltage ≥ Boost Charging Voltage ≥ Float Charging Voltage > Boost Reconnect Charging Voltage.

II. Over Voltage Disconnect Voltage > Over Voltage Reconnect Voltage

III. Low Voltage Reconnect Voltage > Low Voltage Disconnect Voltage ≥ Discharging Limit Voltage.

IV. Under Voltage Warning Reconnect Voltage > Under Voltage Warning Voltage  $\geq$  Discharging Limit Voltage.

V. Boost Reconnect Charging voltage > Low Voltage Disconnect Voltage.

- The following rules must be observed when modifying the parameters value in User for lithium battery.

I. Over Voltage Disconnect Voltage > Over charging protection voltage (Protection Circuit Modules (PCM)) + 0.2V\*;

II. Over Voltage Disconnect Voltage > Over Voltage Reconnect Voltage = Charging Limit Voltage  $\geq$  Equalize Charging Voltage = Boost Charging Voltage  $\geq$  Float Charging Voltage > Boost Reconnect Charging Voltage;

III. Low Voltage Reconnect Voltage > Low Voltage Disconnect Voltage  $\geq$  Discharging Limit Voltage;

IV. Under Voltage Warning Reconnect Voltage > Under Voltage Warning Voltage  $\geq$  Discharging Limit Voltage;

V. Boost Reconnect Charging voltage > Low Voltage Disconnect Voltage.;

VI. Low Voltage Disconnect Voltage  $\geq$  Over discharging protection voltage (PCM) + 0.2V\*;



**WARNING: The required accuracy of PCM shall be at least 0.2V. If the deviation is higher than 0.2V, the manufacturer will assume no liability for any system malfunction caused by this. .**



## 5.2 Load working modes

### 5.2.1 LCD setting

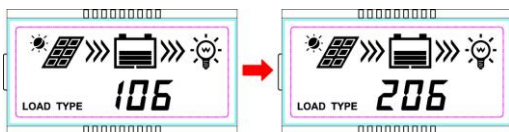
- 1) DS1 module display and operation





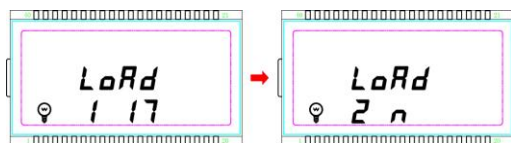

**Operation:**

- Step1:** Press the  button and hold 5s for the load mode interface.
- Step2:** Press the  button when the load mode interface is flashing.
- Step3:** Press the  button to confirm the load working modes.

## 2) DS2 module display and operation



### Operation:

- Step1:** Press the  button for the setting interface.
- Step2:** Press the  button and hold 5s for the load working mode interface.
- Step3:** Press the  or  button to set the load working modes.
- Step4:** Press the  button to confirm the parameters.

## 3) Load working mode

1**	Timer 1	2**	Timer 2
100	Light ON/OFF	2 n	Disabled
101	Load will be on for 1 hour since sunset	201	Load will be on for 1 hour before sunrise
102	Load will be on for 2 hours since sunset	202	Load will be on for 2 hours before sunrise
103 ~ 113	Load will be on for 3~13 hours since sunset	203 ~ 213	Load will be on for 3~13 hours before sunrise
114	Load will be on for 14 hours since sunset	214	Load will be on for 14 hours before sunrise
115	Load will be on for 15 hours since sunset	215	Load will be on for 15 hours before sunrise
116	Test mode	2 n	Disabled
117	Manual mode(Default load ON)	2 n	Disabled



**NOTE:** Please set Light ON/OFF, Test mode and Manual mode via Timer1. Timer2 will be disabled and display "2 n".

## 5.2.2 R485 communication setting

### 1) Load working mode

- Manual Control (default)

Control ON/OFF of the load via the button or remote commands (e.g., APP or PC software).



- Light ON/OFF

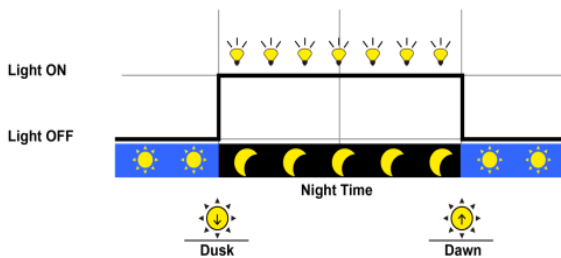

- Light ON+ Timer

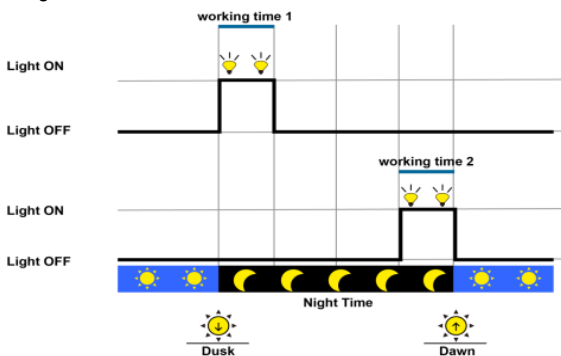

- Time Control

Control the load ON/OFF time through setting the real-time clock.

## 2) Load working mode settings

### (1) PC setting

- Connection

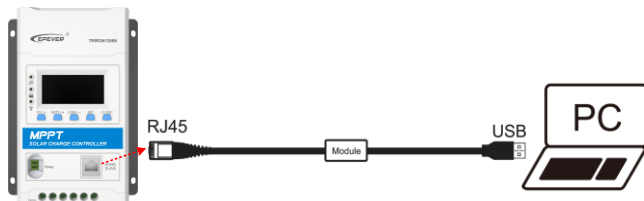

- Download software

<http://www.epever.com>(PC Software for the Solar Charge Controller)

(2) APP software setting

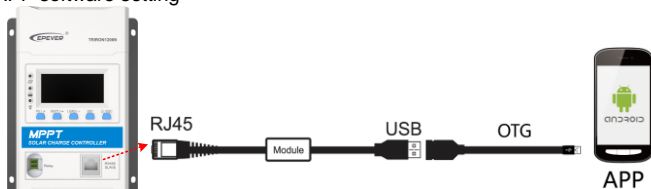

- Download software

<http://www.epever.com>(Android APP for the Solar Charge Controller)

(3) MT50 Setting



**NOTE:** For detailed setting methods, please refer to the instructions or contact after-sales support.

## 6. Protections, Troubleshooting and Maintenance













### 6.1 Protection

PV Over Current	When the charging current or power of the PV array exceeds its rated current or power, it will be charged at the rated current or power.
PV Short Circuit	When not in PV charging state, the controller will not be damaged in case of a short-circuiting in the PV array.
PV Reverse Polarity	When the polarity of the PV array is reversed, the controller may not be damaged and can continue to operate normally after the polarity is corrected. <b>NOTE: If the PV array is reverse connected to the controller, 1.5 times rated controller power (watts) from the PV array, will damage the controller.</b>
Night Reverse Charging	Prevents the battery from discharging through the PV module at night.
Battery Reverse Polarity	Fully protected against battery reverse polarity; no damage to the controller will result. Correct the miswire to resume normal operation.
Battery Over Voltage	When the battery voltage reaches the over voltage disconnect voltage, it will automatically stop battery charging to prevent battery damage caused by over-charging.
Battery Over Discharge	When the battery voltage reaches the low voltage disconnect voltage, it will automatically stop battery discharging to prevent battery damage caused by over-discharging. (Any controller connected loads will be disconnected. Loads directly connected to the battery will not be affected and may continue to discharge the battery.)
Battery Overheating	The controller can detect the battery temperature through an external temperature sensor. The controller stops working when its temperature exceeds 65 °C and begins working when its temperature is below 55 °C.
Lithium Battery Low Temperature	When the temperature detected by the optional temperature sensor is lower than the Low Temperature Protection Threshold (LTPT), the controller will stop charging and discharging automatically. When the detected temperature is higher than the LTPT, the controller will be working automatically (The LTPT is 0 °C by default and can be set within the range of 10 ~ -40 °C).
Load Short Circuit	When the load is short circuited (The short circuit current is $\geq 4$ times the rated controller load current), the controller will automatically cut off the output. If the load reconnects the output automatically five times (delay of 5s, 10s, 15s, 20s, 25s), it needs to be cleared by pressing the Load button, restarting the controller or switching from Night to the Day (nighttime > 3 hours).
Load Overload	When the load is overloading (The overload current is $\geq 1.05$ times the rated load current), the controller will automatically cut off the output. If the load reconnects automatically five times (delay of 5s, 10s, 15s, 20s, 25s), it needs to be cleared by pressing the Load button restarting the controller, switching from Night to Day (nighttime > 3 hours).
Controller Overheating *	The controller is able to detect the temperature inside the battery through an optional remote sensor. The controller stops working when its temperature exceeds 85 °C and begins working when its temperature is below 75 °C.
TVS High Voltage Transients	The internal circuitry of the controller is designed with Transient Voltage Suppressors (TVS) which can only protect against high-voltage surge pulses with less energy. If the controller is to be used in an area with frequent lightning strikes, it is recommended to install an external surge arrester.

★When the internal temperature is 81°C, the reducing power charging mode which reduce the charging power of 5%,10%,20%,40% every increase 1 °C is turned on. If the internal temperature is greater than 85°C, the controller will stop charging. But while the temperature decline to be below 75 °C, the controller will resume.

## 6.2 Troubleshooting

### ● Controller Faults

Faults	Possible reasons	Troubleshooting
Charging LED indicator off during daytime when sunshine falls on PV modules properly	PV array disconnection	Confirm that PV and battery wire connections are correct and tight
Wire connection is correct, the controller is not working.	Battery voltage is lower than 9V	Please check the voltage of battery. At least 9V voltage to activate the controller.
<b>DB1:</b> Charging indicator Green fast flashing	Battery over voltage	Check if battery voltage is higher than OVD(over voltage disconnect voltage), and disconnect the PV.
<b>DS1:</b>   Battery level shows full, battery frame blink, fault icon blink		
<b>DS2:</b> Charging indicator Green fast flashing Battery level shows full, battery frame blink, fault icon blink  		
<b>DB1:</b> Battery indicator Red on solid	Battery over discharged	When the battery voltage is restored to or above LVR(low voltage reconnect voltage), the load will recover
<b>DS1:</b>   Battery level shows empty, battery frame blink, fault icon blink		
<b>DS2:</b> Battery indicator Red on solid   Battery level shows empty, battery frame blink, fault icon blink		
<b>DB1:</b> Battery indicator Red slowly flashing	Battery Overheating	The controller will automatically turn the system off. But while the temperature decline to be below 55 °C, the controller will resume.
<b>DS1:</b>   Interface blink		
<b>DS2:</b> Battery indicator Red slowly flashing  		

<b>DB1</b> PV/BATT(orange)/Battery capacity lever(four) indicator fast flashing <b>DS2:</b> PV/BATT(orange)indicator fast flashing	Controller Overheating	When heat sink of controller exceeds 85℃, the controller will automatically cut input and output circuit. When the temperature below 75℃,the controller will resume to work.
	System voltage error	①Check whether the battery voltage match with the controller working voltage. ②Please change to a suitable battery or reset the working voltage.
The load is no output DS1/DS2:  Load and fault icon blink	Load Overload	①Please reduce the number of electric equipments. ②Restart the controller. ③wait for one night-day cycle (night time>3 hours).
	Load Short Circuit	①Check carefully loads connection, clear the fault. ②Restart the controller. ③wait for one night-day cycle (night time>3 hours).

### ●Inverter fault

Inverter fault	Fault code	LCD	Indicator
Output short circuit	E001	Fault icon blink (1S)	Load indicator blink
Output overload	E002		
Output voltage abnormal	E003		
Input over voltage	E005		
Input low voltage	E006		
Input over current	E007		
Overheating	E008		
Communication timeout	E099		



**NOTE:** With combination of the RCM and DS1/DS2 modules, the information of the inverter (to be supplied by our company) can be displayed by the DS1/DS2 module.

## 6.3 Maintenance

The following inspections and maintenance tasks are recommended at least two times per year for best performance.

- Make sure controller firmly installed in a clean and dry ambient.
- Make sure no block on air-flow around the controller. Clear up any dirt and fragments on radiator.
- Check all the naked wires to make sure insulation is not damaged for serious solarization, frictional wear, dryness, insects or rats etc. Repair or replace some wires if necessary.
- Tighten all the terminals. Inspect for loose, broken, or burnt wire connections.
- Check and confirm that LED is consistent with required. Pay attention to any troubleshooting or error indication .Take corrective action if necessary.
- Confirm that all the system components are ground connected tightly and correctly.
- Confirm that all the terminals have no corrosion, insulation damaged, high temperature or burnt/discolored sign, tighten terminal screws to the suggested torque.
- Check for dirt, nesting insects and corrosion. If so, clear up in time.
- Check and confirm that lightning arrester is in good condition. Replace a new one in time to avoid damaging of the controller and even other equipments.



**WARNING: Risk of electric shock!**

**Make sure that all the power is turned off before above operations, and then follow the corresponding inspections and operations.**

# 7. Technical Specifications

## Electrical Parameters

Item	TRIRON 1206N	TRIRON 2206N	TRIRON 1210N	TRIRON 2210N	TRIRON 3210N	TRIRON 4210N	TRIRON 4215N
System nominal voltage	12/24VDC Auto <sup>①</sup>						
Rated charge current	10A	20A	10A	20A	30A	40A	40A
Rated discharge current	10A	20A	10A	20A	30A	40A	40A
Battery voltage range	8~32V						
Max. PV open circuit voltage	60V <sup>②</sup> 46V <sup>③</sup>		100V <sup>②</sup> 92V <sup>③</sup>				150V <sup>②</sup> 138V <sup>③</sup>
MPP voltage range	(Battery voltage +2V) ~36V		(Battery voltage +2V)~72V				(Battery voltage +2V)~108V
Max. PV input power	130W/12V 260W/24V	260W/12V 520W/24V	130W/12V 260W/24V	260W/12V 520W/24V	390W/12V 780W/24V	520W/12V 1040W/24V	520W/12V 1040W/24V
Self-consumption	≤14mA(12V); ≤15mA(24V)						
Discharge circuit voltage drop	≤0.18V						
Temperature compensate coefficient <sup>④</sup>	-3mV/°C/2V (Default)						
Grounding	Common negative						
RS485 interface	5VDC/100mA						
USB interface	5VDC/2.2A(Total)						
Relay interface	30VDC/1A						
Backlight time	60S (Default)						

①When a lead-acid battery is used, the controller hasn't the low temperature protection.

②At minimum operating environment temperature

③At 25°C environment temperature

④When a lithium-ion battery is used, the system voltage can't be identified automatically.

## Environmental Parameters

Working environment temperature*	-25℃~+55℃(LCD) -30℃~+55℃ (No LCD)
Storage temperature range	-20℃~+70℃
Relative humidity	≤95%, N.C
Enclosure	IP30

\*The controller can full load working in the working environment temperature, When the internal temperature is 81℃, the reducing power charging mode is turned on. Refer to P36.

## Mechanical Parameters

Item	TRIRON1206N TRIRON1210N	TRIRON2206N TRIRON2210N	TRIRON3210N	TRIRON4210N TRIRON4215N
Dimension	135×180.8×47.3mm	150×216×56.7mm	158×238.3×62.7mm	183×256.8×66.7mm
Mounting dimension	126×150mm	141×170mm	158×200mm	174×220mm
Mounting hole size	Φ5mm			
Terminal	12AWG(4mm <sup>2</sup> )	6AWG(16mm <sup>2</sup> )	6AWG(16mm <sup>2</sup> )	6AWG(16mm <sup>2</sup> )
Recommended cable	12AWG(4mm <sup>2</sup> )	10AWG(6mm <sup>2</sup> )	8AWG(10mm <sup>2</sup> )	6AWG(16mm <sup>2</sup> )
Weight	0.56kg	0.92kg	1.35kg	2.06kg

## Module Parameters

Item	DB1	DS1	DS2	UCS	RCM	RCS	USB1
Self-consumption	2mA	3mA	4mA	6.5mA	3.5mA	4mA	6.5mA
Dimension	88.5×56×23.1mm			88.5×28×19.2mm			
Weight	25g	55g	55g	30g	20g	20g	26g



# Annex I Conversion Efficiency Curves

Illumination Intensity:  $1000\text{W/m}^2$  Temp:  $25^\circ\text{C}$

Model: TRIRON1206N

1. Solar Module MPP Voltage(17V, 34V) / Nominal System Voltage(12V)

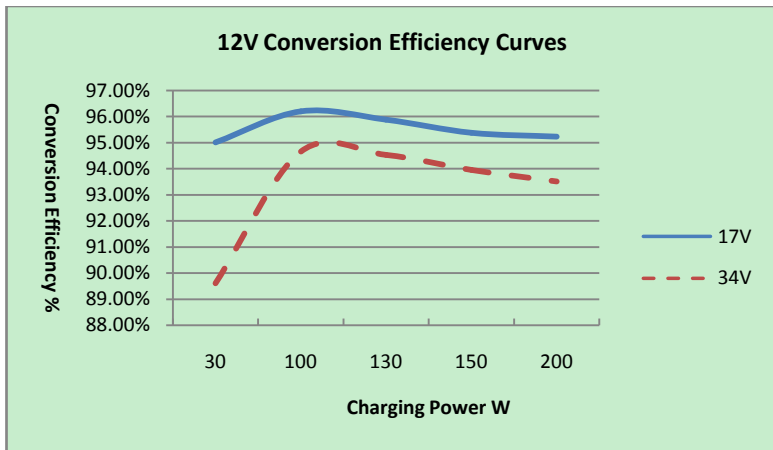

2. Solar Module MPP Voltage(34V) / Nominal System Voltage(24V)

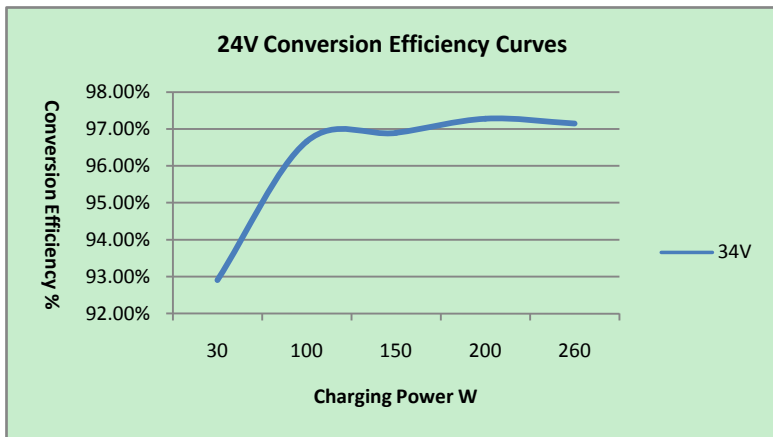

**Model: TRIRON2206N**

1. Solar Module MPP Voltage(17V, 34V) / Nominal System Voltage(12V)

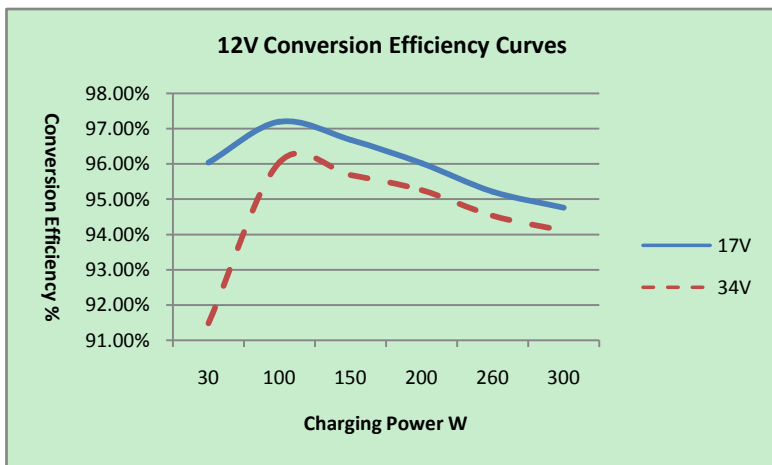

2. Solar Module MPP Voltage(34V) / Nominal System Voltage(24V)

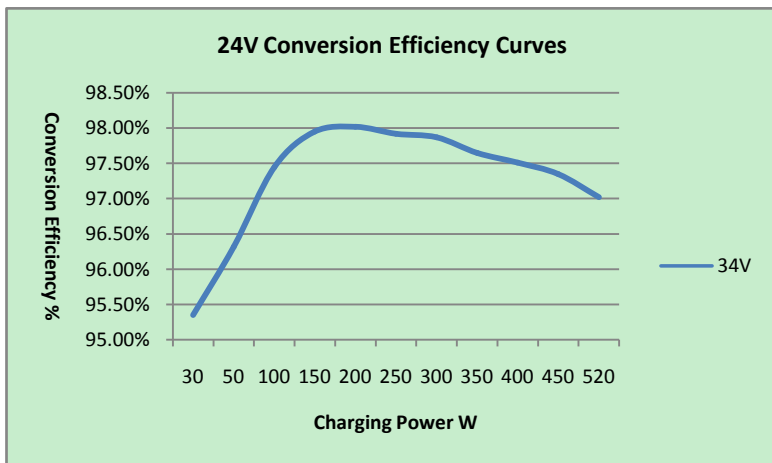

## Model: TRIRON2210N

1. Solar Module MPP Voltage (17V, 34V,51V) / Nominal System Voltage(12V)

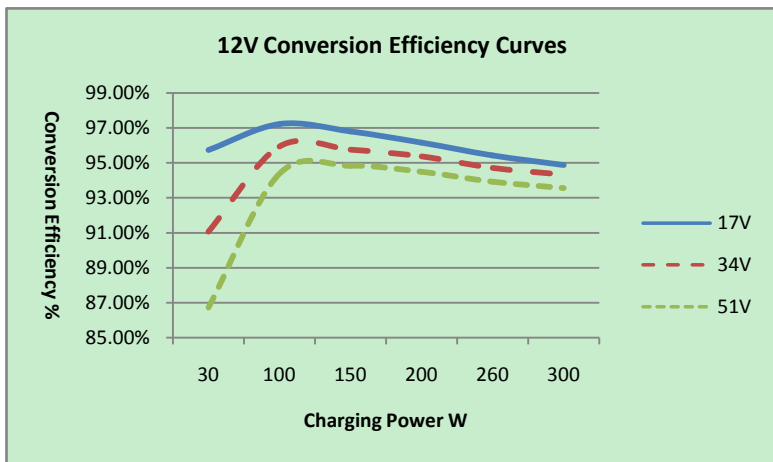

2. Solar Module MPP Voltage (34V,51V,68V) / Nominal System Voltage(24V)

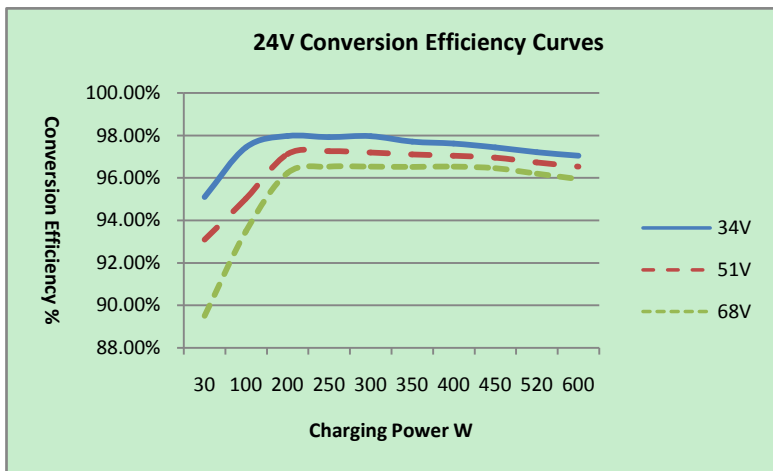

**Model: TRIRON3210N**

1. Solar Module MPP Voltage (17V, 34V,51V) / Nominal System Voltage(12V)

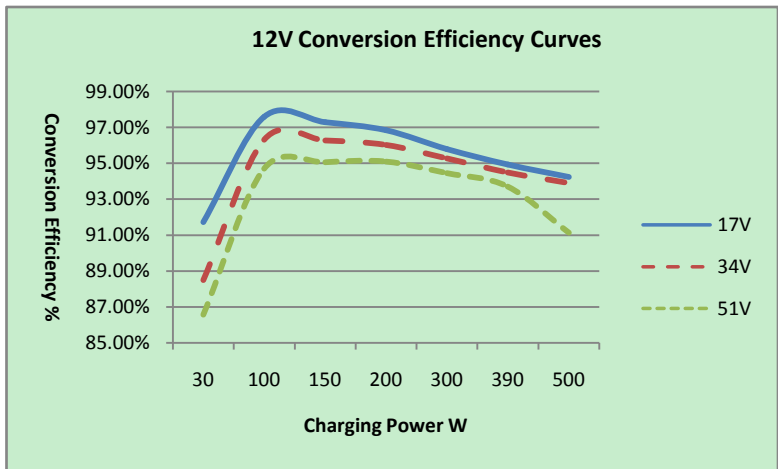

2. Solar Module MPP Voltage (34V,51V,68V) / Nominal System Voltage(24V)

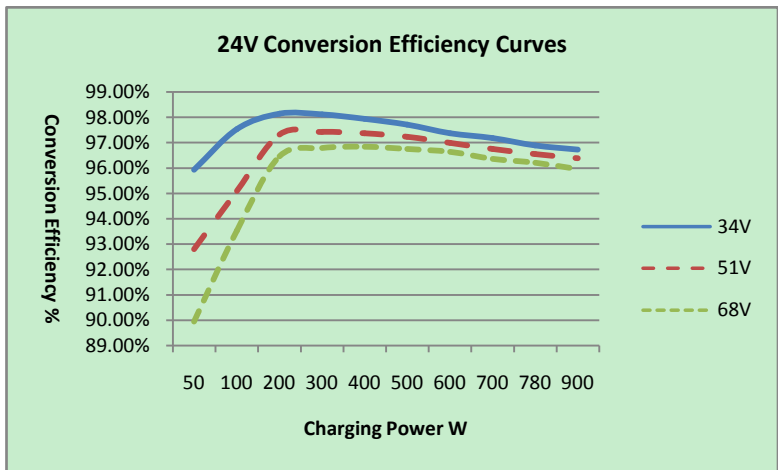

**Model: TRIRON4210N**

1. Solar Module MPP Voltage (17V, 34V,51V) / Nominal System Voltage(12V)

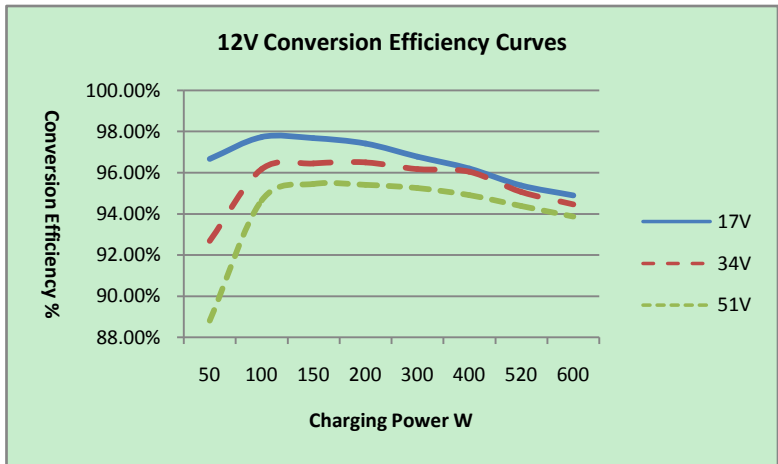

2. Solar Module MPP Voltage (34V,51V,68V) / Nominal System Voltage(24V)

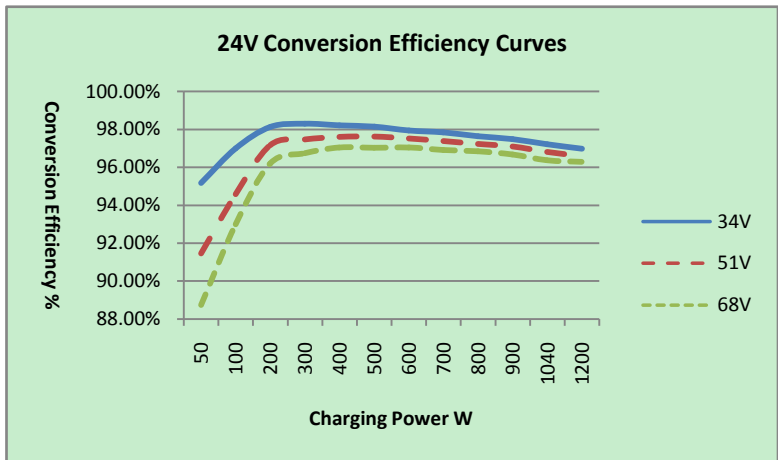

## Model: TRIRON4215N

1. Solar Module MPP Voltage (16.5V, 33V,66V) / Nominal System Voltage(12V)

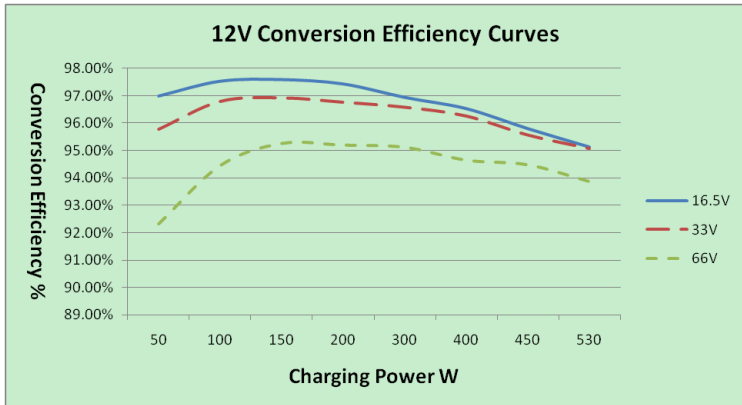

2. Solar Module MPP Voltage (33V,66V,98V) / Nominal System Voltage(24V)

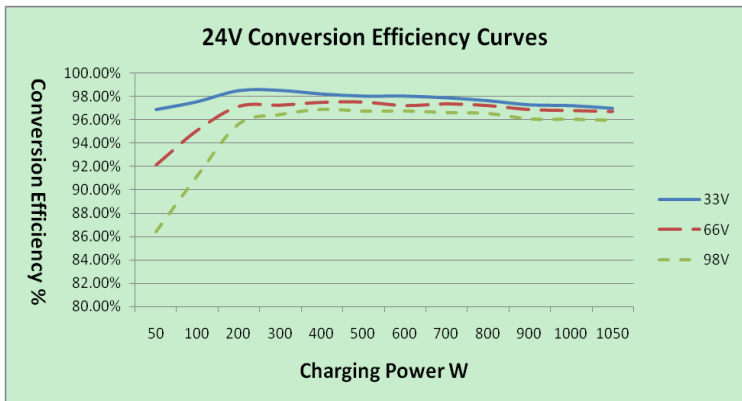

## Annex II Dimensions

TRIRON1206N/TRIRON1210N (Unit: mm)

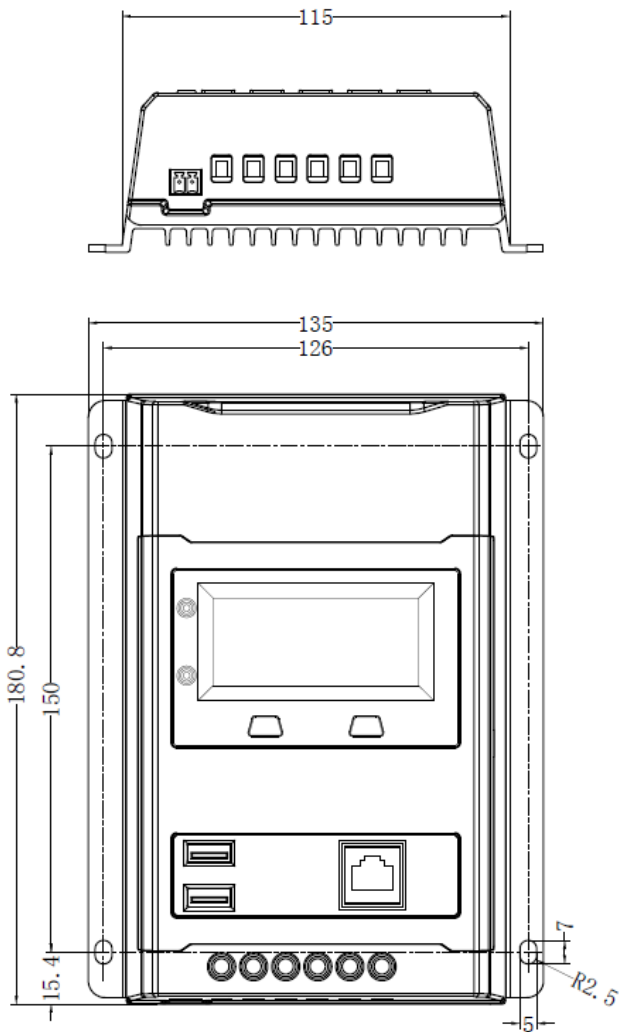

TRIRON2206N/ TRIRON2210N (Unit: mm)

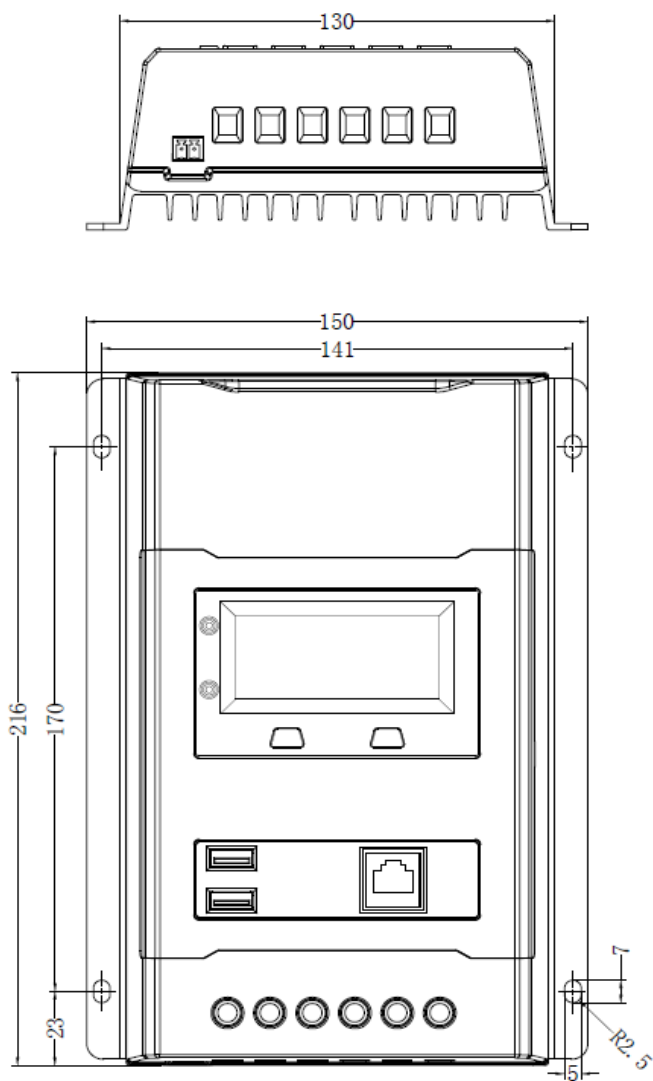



TRIRON3210N (Unit: mm)

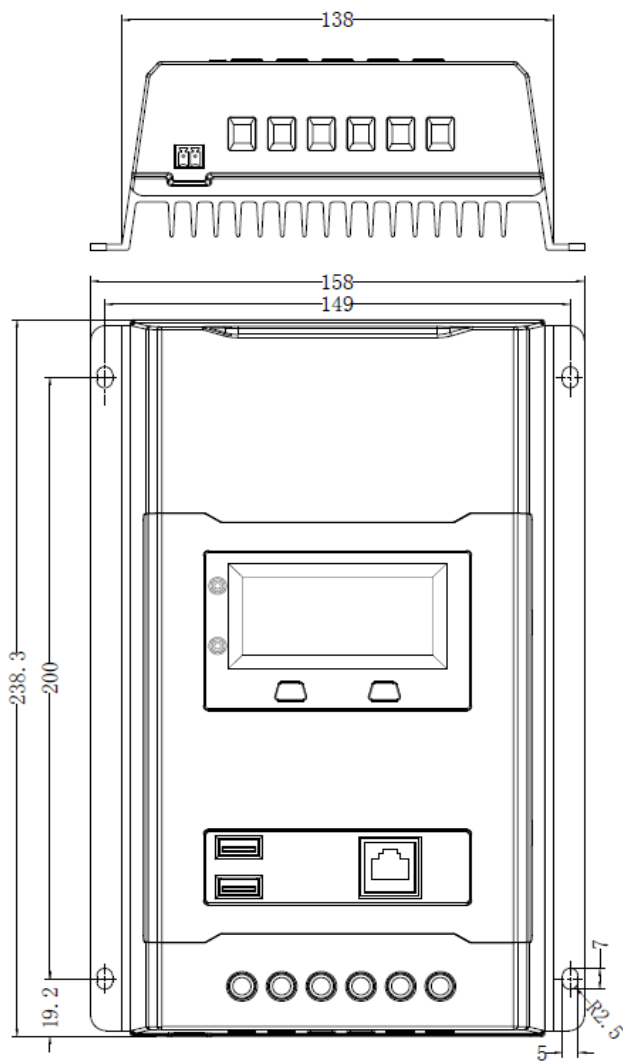

**TRIRON4210N/ TRIRON4215N (Unit: mm)**

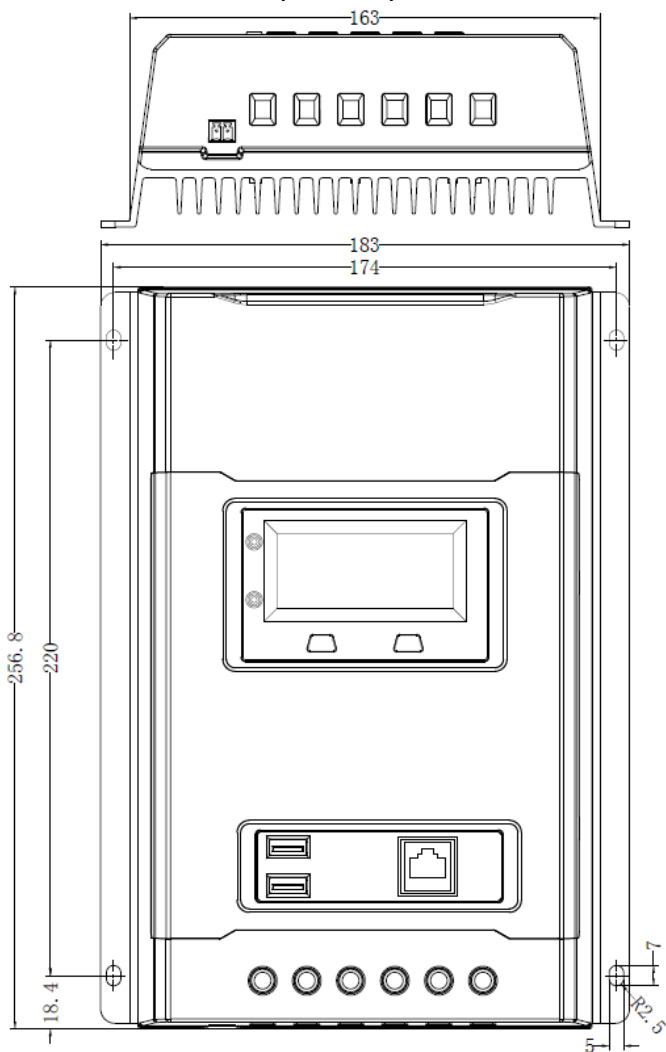

**Any changes without prior notice!**

**Version number: 1.0**





**BEIJING EPSOLAR TECHNOLOGY CO., LTD.**

**Tel: +86-10-82894112 / 82894962**

**Fax: +86-10-82894882**

**E-mail: [info@epsolarpv.com](mailto:info@epsolarpv.com)**

**Website: <http://www.epsolarpv.com/>**

**<http://www.epever.com/>**