



275L / 10 cu. ft.

== *Classic* ==  
(by UNIQUE)

# SOLAR POWERED DC FRIDGE

---

UGP-275L W



---

OWNER'S GUIDE  
serial number:

# TABLE OF CONTENTS

03	Important safety notes
07	Installation
08	Parts list
9	DC power connection
11	Operation
15	Cleaning
15	Energy saving tips
16	Troubleshooting
18	Appliance information
18	Parts diagram and list
21	Notes
22	Contact us
22	Limited warranty
Back	Technical specifications

# IMPORTANT SAFETY NOTES

**IMPORTANT:** After transit where the fridge has been on its side or back, ensure that the fridge is in a level, upright position for 12 hours to allow compressor fluids to redistribute evenly before use.

**Congratulations!** You have purchased one of the most efficient refrigeration products available on the market today. The Unique 275L W solar powered DC fridge is designed to provide years of efficient trouble-free operation. The design is optimized for energy savings with an efficient DC compressor and efficient insulation.

Before using the appliance, read through this manual carefully including all the information on safety, installation, operation, and cleaning. These guidelines do not cover every possible condition or situation that may occur. Be safe using common sense and caution when installing, operating and cleaning this appliance. If you are unsure about any of these instructions or warnings, contact your local product dealer or Unique Appliances for assistance.

## **IMPORTANT SAFETY NOTES** continued

- To allow the interior to cool down properly, run the fridge for at least 4 hours empty before adding food.
- This fridge is designed to operate on 12 or 24 volts DC ONLY. **DO NOT CONNECT THIS FRIDGE TO AN AC (alternating current) POWER SOURCE DIRECTLY - YOU CAN PURCHASE AN AC/DC CONVERTOR IF NEEDED.**
- This fridge is designed for domestic use only! It is intended for the storage of edible/consumable food and drinks. It is not intended for commercial or industrial use.
- Never use excessive force on the handle to open the door.
- If the room/ambient temperature approaches the fridge's operating temperature, the fridge may not function correctly. If the room/ambient temperature exceeds 100°F (38°C) the fridge may not function correctly.
- A DC powered fridge has a lower cooling capacity than typical AC-powered appliances. Because the compressor is small, the fridge/freezer runs more efficiently but lacks the ability to cool larger warm loads as quickly as typical AC-powered appliances.

# IMPORTANT SAFETY NOTES continued

These warnings are provided in the interest of your safety. Please ensure that you understand them all before installing or using this fridge. Your safety is of paramount importance. If you are unsure about any of these meanings or warnings, contact your local product dealer or Unique Appliances for assistance.

## **PRIOR TO INSTALLATION:**

At delivery, please check that the fridge is complete and has not been damaged during transport. It is not advised to connect an appliance that has been damaged, especially damage to the electrical supply cable or refrigerant circuit. In the event of damage please contact your local product dealer or Unique Appliances for assistance.

## **GENERAL SAFETY**

- Before cleaning or repositioning the fridge/freezer, always disconnect from the electrical power supply.
- Service the fridge/freezer only if you are a trained or authorized refrigeration technician.
- This appliance contains refrigerant R-134a and a polyolester compressor oil in its refrigerant circuit. Take utmost care when handling your fridge so as to not cause damage to the refrigerant circuit with consequent possible leakage.
- Do not use other electrical appliances (such as ice cream makers) inside of the refrigerating appliance.

## **CHILD SAFETY**

- **Do not allow children to play in, on or around the fridge. It is not a toy. THERE IS A DANGER OF SUFFOCATION IF A CHILD BECOMES TRAPPED INSIDE.**
- When the appliance is not in use, secure or remove the doors to prevent children from playing inside the cabinets.
- **DANGER OF SUFFOCATION** - Keep children away from all packaging material.

## **INSTALLATION**

- This appliance is heavy. Care should be taken when moving it.
- This appliance operates on 12 or 24 Volts DC (Direct Current) only!
- Under no circumstances should this appliance be directly connected to an AC (Alternating Current) power source.
- Be sure that the appliance does not stand on the electrical

## **IMPORTANT SAFETY NOTES** continued

supply cable. Also, be sure the electrical cable is not squeezed or bent when the appliance is being installed or moved.

- Installation work and adjustments on the appliance must be carried out by qualified personnel only. Work performed by persons with inadequate technical knowledge may adversely effect the performance of the appliance, causing damage to the equipment, and void the warranty.
- It is dangerous to make alterations or attempt to modify this product in any way. Product alterations will void the warranty.

### **DURING USE**

- This appliance is designed for domestic use only, specifically for the storage of food and drinks. This appliance is not designed for commercial or industrial use.
- Do not store any containers with flammable vapors or liquids in or around the appliance, such as organic solvents, spray cans, gas cans, etc. **Danger of explosion!**

### **CLEANING**

- Before cleaning always turn the fridge/freezer off and disconnect it from the electrical power supply.
- Allow inside of fridge/freezer to fully thaw, then wash the inside and outside of the appliance with luke warm water and a mild soap or detergent. Abrasive or corrosive cleaning agents, steel wool, scouring sponges, or chemical cleaning agents should not be used under any circumstances.

### **SERVICING**

- This product should be serviced by an authorized technician and only genuine spare parts should be used.
- Under no circumstances should you attempt to repair the appliance yourself. Repairs carried out by inexperienced persons may cause injury or serious malfunctioning of the appliance. **Unauthorized work may void the warranty.**

### **DISPOSING OF THE APPLIANCE**

- When disposing of your fridge, use an authorized disposal site. The refrigerant must be completely drained and collected by an authorized technician for recycling prior to disposal. Check with your local Environmental Agency for recommendations on recycling this appliance in your area. Remove the electrical connection wiring and also ensure that the lid is removed to prevent children from being trapped inside - **DANGER OF SUFFOCATION!**

# INSTALLATION

## UNPACKING AND CLEANING

Remove all packaging and securing tapes from the appliance. To avoid injury and causing damage to the appliance, be extremely cautious when using sharp or pointed tools to complete this task. Keep children away from the packaging material - **DANGER OF SUFFOCATION!** Wash the inside and outside of the appliance with luke warm water and a mild soap or detergent. Abrasive or corrosive cleaning agents, steel wool, scouring sponges, or chemical cleaning agents **should not** be used under any circumstances. A sponge, soft brush or towel is recommended. After cleaning, thoroughly rinse and dry. You may want to leave the doors open allowing the compartments to ventilate for 20-30 minutes to get rid of residual odors. Check with your local Environmental Agency for recommendations on recycling packaging materials in your area.

## POSITIONING THE APPLIANCE

The area in which the fridge is to be installed must be relatively cool, dry, and suitably ventilated. The area must be protected against any inclement weather (rain, snow) and excessive surface dust. To ensure proper function, the appliance must be placed on a flat, firm, and stable surface resting level on all four supports. The floor must be strong enough to support a fully loaded cabinet. Use wood or metal shims to level the fridge if necessary.

Do not place the fridge close to heat sources (heater, stove, boiler, chimney, etc.), and avoid prolonged exposure to direct sunlight. This appliance uses the exterior walls to transfer heat from the inside of the cabinet. Ensure that there is adequate space between the fridge and neighboring walls or large objects. A minimum spacing of 3 inches (7.5 cm) is highly recommended. This will provide sufficient airflow around the appliance resulting in more efficient operation and longer appliance lifetime. Always keep the air vent openings of the compressor housing cover free from dust and obstructions.

# PARTS LIST

## PARTS LIST

- 1: Shelf
- 2: Freezer compartment
- 3: Freezer drawers
- 4: Thermostat 0 - 7
- 5: Door
- 6: Upper hinge
- 7: Lower hinge
- 8: Adjustable feet
- 9: Crisper
- 10: Detachable door rack
- 11: Middle hinge
- 12: Egg Tray
- 13: Power Cable
- 14: AC/DC Plug (optional for on-grid use)
- 15: Ice Scraper
- 16: Drain Cleaner
- 17: Ice tray

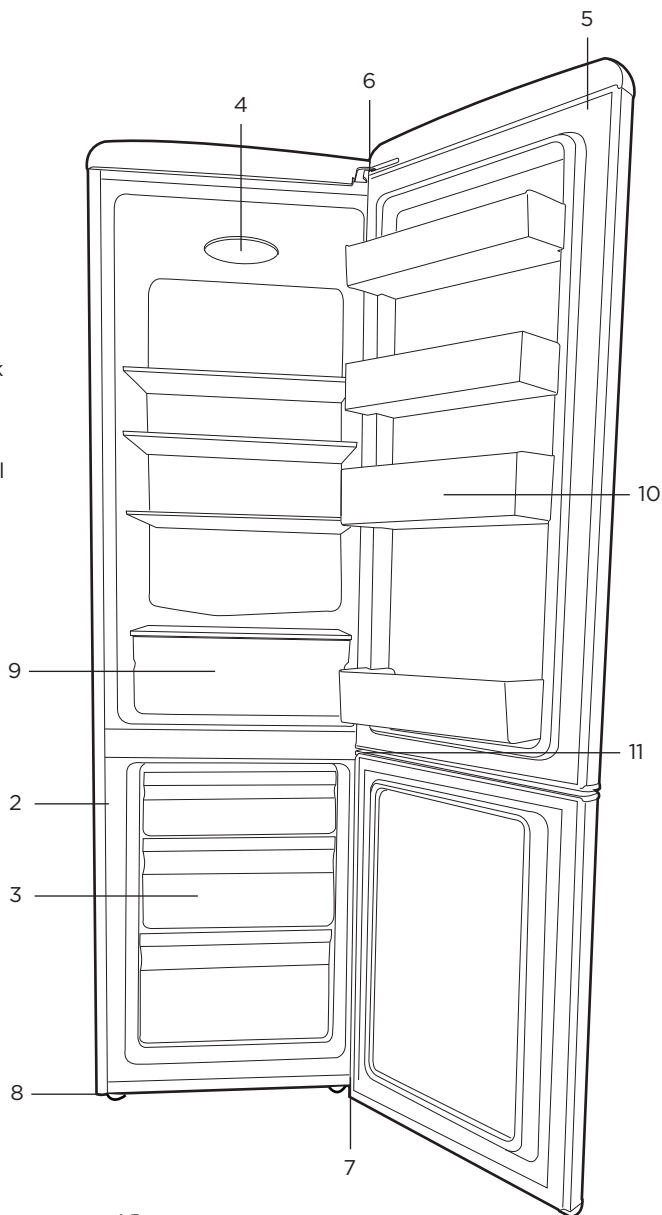

12

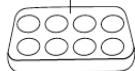

13

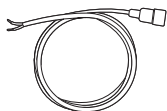

14

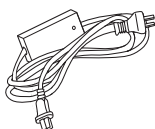

AC/DC plug  
(optional for on-grid  
use) **\*sold separately**

15

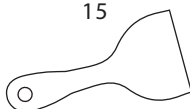

16



17

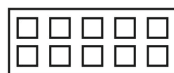



# DC POWER CONNECTION

**THIS FRIDGE MUST NEVER BE CONNECTED DIRECTLY TO ANY AC (alternating current) POWER SOURCE!**

**THE FRIDGE MUST ONLY BE CONNECTED TO A 12V OR 24V DC POWER SOURCE, SUCH AS A SOLAR BATTERY SYSTEM OR CHARGE CONTROLLER.**

**THE FRIDGE WILL AUTOMATICALLY OPERATE ON EITHER 12V OR 24V DC. THE USER DOES NOT NEED TO MAKE ANY ADJUSTMENT.**

**ATTENTION:** Polarity is important in wiring this DC appliance. Be sure that the positive terminal of the battery or charge controller coincides with the positive wire to the compressor, and the negative terminal of the battery or charge controller coincides with the negative wire to the compressor. The leads should be connected using cable shoes and screwed connections. Joined leads should be avoided.

**+ to + and - to -**

**positive to positive / negative to negative**

**(red wire) / (black wire)**

## ELECTRICAL DIAGRAM

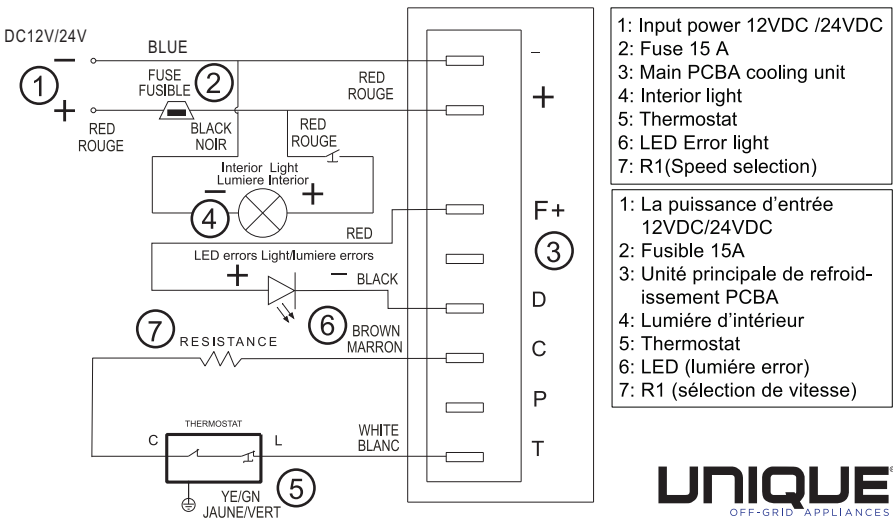

**UNIQUE**  
OFF-GRID APPLIANCES

# DC POWER CONNECTION continued

## IN-LINE FUSE

A 15A in-line fuse is provided with this fridge in order to protect the wiring. **For 12V operation, use a 15A fuse.** A standard automobile fuse is recommended and the fuse should be wired to the positive (“+”) side of the system close to the positive battery terminal.

***A 15A fuse is provided with this fridge/freezer.***

OPERATING VOLTAGE	FUSE
12 V / 24 V	15 A

## ATTENTION

If a longer connection cable is necessary, the cable cross section (or gauge) must be equal to or greater than the cable sizes recommended on the following table. Be careful that the input voltage at the appliance does not drop below the cut-out voltage of the compressor.

CABLE SIZE		12V CABLE LENGTH		24V CABLE LENGTH	
AREA	AWG				
mm <sup>2</sup> /inch	Gauge	m	ft	m	ft
2.5 / <sup>3</sup> / <sub>32</sub> ”	12	2.5	8	5	16
4 / <sup>5</sup> / <sub>32</sub> ”	12	4	13	8	26
6 / <sup>15</sup> / <sub>64</sub> ”	10	6	19.5	12	39
10 / <sup>25</sup> / <sub>64</sub> ”	8	10	32.8	20	65.6

## LOW VOLTAGE DISCONNECT

The compressor electronics includes a low voltage disconnect feature. If the input voltage to the appliance falls below 10.4V (in 12 V mode) or 22.8V (in 24 V mode), the compressor will shut-off. Once the voltage increases above 11.7V (in 12V mode) or 24.2V (in 24V mode), the compressor will resume normal operation.

This feature is designed to protect the system battery from experiencing too low a depth of discharge.

	12 V OPERATION	24 V OPERATION
SHUT-OFF	10.4 V	22.8 V
RESTART	11.7 V	24.2 V

# OPERATION

**Your Unique fridge, like any battery-powered refrigerating appliance, requires different care than appliances plugged into an electric utility. Prudent operation is the key to extended service.**

## STARTING THE FRIDGE

After the fridge has been properly connected to the 12 or 24 VDC power source, the compressor will automatically turn on and the cabinet will begin cooling. Allow the cabinet to cool for at least 4 hours prior to adding foodstuff.

## TEMPERATURE CONTROL

The temperature within the fridge and freezer compartments is controlled by the thermostat situated on the inside of the fridge area. When you first start the fridge we suggest that you turn the thermostat to a maximum setting (7) until desired refrigeration temperatures are achieved. The correct internal temperature setting can be found by measuring the temperature of the central or middle portion in the appliance.



OPTIMAL OPERATING TEMPERATURE		
THERMOSTAT SETTING	FRIDGE TEMPERATURE	FREEZER TEMPERATURE
Optimal Setting = 4	1°C to 4°C 33°F to 39°F	-10°C to -15°C 14°F to 5°F
Setting = 7	-4°C / 24.8 °F	-15°C / 5°F
<b>NOTE:</b> Setting 1 being warmest and 7 coldest		

The fridge will run a few degrees colder at high elevations.

**\*NOTE:** Mechanical temperature controller has a + or -, 0.5 range. The fridge will run a few degrees colder at high elevations.

# OPERATION continued

## ADJUSTMENTS

As the ambient temperature changes with the season, it may be necessary to adjust the thermostat to achieve the proper internal temperature. If the room/ambient temperature approaches the appliance's internal operating temperature, the appliance will not function as it should. The appliance will tend to run colder during these conditions and it may be necessary to turn the thermostat to a warmer setting (lower number). If the room/ambient temperature exceeds 100°F (38°C), the appliance will not function as it should. The appliance will tend to run warmer and it may be necessary to turn the thermostat to a colder setting (towards the maximum setting).

## OPENING AND CLOSING THE DOOR

The doors are fitted with uniform sealing strips to prevent warm air and moisture from entering the fridge and freezer compartments. Be sure that the doors and door seals are free from obstructions and form a complete seal around the rim of the fridge/freezer cabinets. Over-stuffing and/or unlevel installation of the appliance will prevent a good seal.

It might be hard to open the door immediately after the door is closed. This is due to air contraction in the fridge/freezer cabinets. This pressure difference will equalize in a few seconds, making the doors easy to open once again.

## LOADING THE FRIDGE AND FREEZER

A battery-powered refrigeration appliance has a cooling capacity lower than typical AC appliances. Because the compressor is smaller, the appliance runs more efficiently but cools warm or room temperature food at a slower rate than an AC appliance.

Avoid packing food too tightly around the cooling plates located on the back wall of the fridge/freezer. Allow air flow around these plates to ensure proper operation.

When adding unfrozen food to the freezer for the first time, fill the freezer only 1/3 full and wait until that food is sufficiently frozen before adding more. It will also help to cool food more quickly if the food is packaged in smaller containers rather than large ones. Food packages more than 2 inches thick will cool slowly. Avoid placing warm food in contact with cold food.

## NORMAL OPERATING SOUNDS

- You may hear faint gurgling or bubbling sounds when the refrigerant is being pumped through the refrigerant coils.
- When the compressor is on, the refrigerant is being pumped through the appliance and you will hear a whirring or pulsing sound from the compressor.

- 12 • A thermostat controls the compressor and you may hear a 'click' when the thermostat cuts in and out.

# OPERATION continued

## DEFROSTING

Before cleaning or repositioning the fridge, you must **DISCONNECT** the appliance from the electrical power supply.

**DEFROSTING THE UNIT** The fridge compartment will become progressively covered with frost. This should be removed periodically with a plastic scraper. However, when the ice becomes very thick on the interior walls, complete defrosting should be carried out. Perform this operation when the appliance is empty and disconnected from the power supply.

**NEVER USE SHARP METAL TOOLS TO SCRAPE OR CHIP OFF FROST FROM THE INTERIOR COMPARTMENT AS THIS COULD DAMAGE THE APPLIANCE BEYOND REPAIR. DO NOT USE HEAT SOURCES SUCH AS ELECTRIC OR GAS HEATERS TO COMPLETE THE DEFROST PROCESS.**

### **To perform a complete defrosting:**

1. Disconnect the appliance from the electrical supply.
2. Remove any stored food and store in coolers, or wrap in several layers of newspaper and store in a cool place.
3. Leave the doors open.
4. Remove the plug from the defrost water drain located in the bottom interior of the cabinet.
5. To accelerate the defrosting process, place a bowl of hot (not boiling) water inside the fridge and/or freezer compartments and close the door.
6. When defrosting is complete, wash and dry the interior thoroughly.
7. Reconnect the appliance to the electrical supply and leave running (while empty) for at least 2 hours allowing the interior to cool sufficiently.
8. Reload the fridge and freezer with the previously removed food.

**ATTENTION: Partial thawing of frozen food during defrosting may shorten its safe storage life-span.**

# OPERATION continued

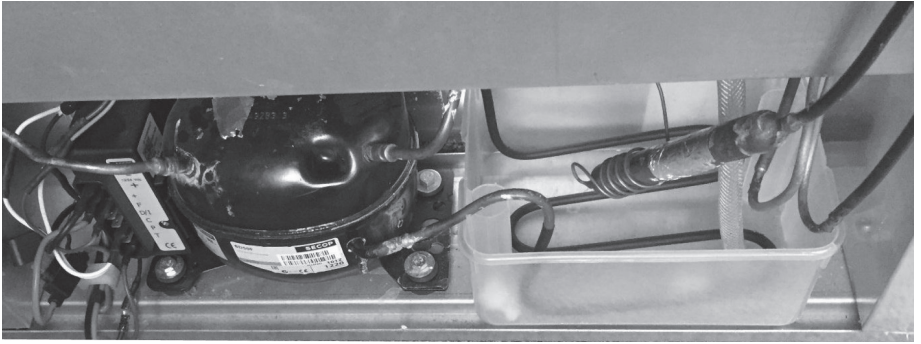

## WATER CATCH BASIN

There is a water catch basin located at the back of the fridge for excess water or as a result of defrosting. The hot condenser coil runs into the water catch basin and evaporates the water slowly:

**NOTE:** Take notice when doing a complete defrost as the water catch basin could overflow with large volumes of water going in the water catch basin all at once.

## Operational errors

Error code or LED flashes	Error type  Can be read out in the software TOOL4COOL®
6	<b>Thermostat failure</b> (If the NTC thermistor is short-circuit or has no connection).
5	<b>Thermal cut-out of electronic unit</b> (If the refrigeration system has been too heavily loaded, or if the ambient temperature is high, the electronic unit will run too hot).
4	<b>Minimum motor speed error</b> (If the refrigeration system is too heavily loaded, the motor cannot maintain minimum speed at approximately 1,850 rpm).
3	<b>Motor start error</b> (The rotor is blocked or the differential pressure in the refrigeration system is too high (>5 bar)).
2	<b>Fan over-current cut-out</b> (The fan loads the electronic unit with more than 0.5A <sub>avg</sub> ).
1	<b>Battery protection cut-out</b> (The voltage is outside the cut-out setting).

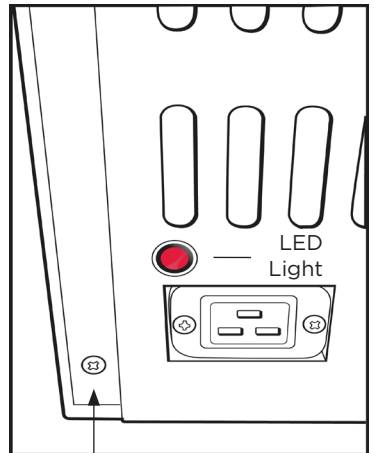

Remove 4 screws from grates to access 15A fuse



14 **NOTE:** When fridge is connected to a power adaptor or to a battery, light indicator will not light up.

# CLEANING

## Internal Cleaning

Wash the inside of the appliance with luke warm water and a mild soap. Never use abrasive or corrosive cleaning agents, steel wool, scouring sponges, chemical cleaning agents, or highly perfumed cleaning products to clean the interior as these will damage the surface and leave behind a strong odor. A sponge, towel, or soft brush is recommended. Wash with a mixture of two tablespoons (30ml) of baking soda to 1 quart (1.14L) warm water. After cleaning, wipe all surfaces with a soft cloth and clean water to rinse, and allow the fridge/freezer to dry.

## External Cleaning

Wash the outside of the cabinet with warm water and a mild soap or detergent.

Do not use abrasive or corrosive cleaning agents, chemical cleaning agents, steel wool or scouring sponges to clean the fridge as it may cause damage to the surfaces.

# ENERGY SAVING TIPS

- Do not install the fridge close to sources of heat, such as a stove, boiler, heater, chimney, etc, and avoid exposure of the appliance to direct sunlight.
- Locate the appliance in a cool well-ventilated room and make sure that the air vents of the compressor housing cover are not obstructed. Also allow adequate spacing around the cabinet for air circulation (3" or 7.5cm)
- Avoid unnecessary frosting in the cabinet by packing all food and liquids in airtight packages or containers.
- Always keep food stored in tightly sealed packaging or containers, and allow some space for air to circulate around each item.
- Avoid keeping the door open for extended periods of time or opening the door too frequently as warm air will enter the cabinet and cause the compressor to run unnecessarily often.
- Ensure there are no obstructions preventing the doors from closing properly and forming a tight seal.
- To ensure a safe food storage temperature, maintain an operating temperature inside the fridge cabinet of 2°C/36°F to 4°C/39°F.  
**Fridge temperatures warmer than 4°C/39°F can promote unsafe bacterial growth in food.**

# TROUBLESHOOTING

Before contacting a service technician, your local product dealer or Unique Appliances, please check the following points. If you contact a technician to repair a fault listed below, or to repair a fault caused by misuse, abuse, or faulty installation, a charge will be made even if the appliance is under warranty.

PROBLEM	SOLUTION
Appliance is connected to power, but does not operate	<ul style="list-style-type: none"> <li>• Check if 12V or 24V DC is present at the appliance. If not, check all connections and the system battery voltage.</li> <li>• Check that the polarity is correct: positive (+) is connected to positive (+), and negative (-) is connected to negative (-).</li> <li>• Check the fuse. If blown, replace with a new one (see page 11 for details).</li> <li>• The primary problem with a non-functioning appliance is due to a voltage drop to the compressor, which causes the unit to fail to start due to “low voltage”. Typically a connection is not as tight as it should be, or the wire size to the compressor is too small. The low voltage problem occurs instantly at start-up and can be difficult to detect with a volt meter because it happens so quickly (&lt;100ms)</li> </ul>
Appliance is operating, but the interior (cabinet) is not cold	<ul style="list-style-type: none"> <li>• Allow the appliance at least 4 hrs to cool down once turned on.</li> <li>• Check that the thermostat control knob is turned to the correct setting relevant to the room/ambient temperatures.</li> <li>• Check that the room/ambient temperature is not approaching the internal operating temperature and does not exceed to 100°F (38°C).</li> <li>• Has too much warm food been added to the fridge/freezer recently? If so, it will take some time for the appliance to return to temperature.</li> <li>• Does the cabinet have adequate ventilation around the side walls, allowing it to transfer heat properly? (See Installation section)</li> </ul>
The door will not open	<ul style="list-style-type: none"> <li>• Has the door just been opened? If so, leave the appliance closed for a few minutes to allow the air pressure to equalize and try again.</li> </ul>



## TROUBLESHOOTING continued

Excessive frost and ice has built up	<ul style="list-style-type: none"><li>• Is the weather hot and humid? If so, this will increase the rate of frost build-up in the cabinet.</li><li>• Ensure that stored food is properly packaged.</li><li>• Check that the door is closed and has a good seal, and that nothing is preventing the door from closing properly.</li><li>• Large quantities of food have recently been placed in the fridge/freezer, and/or the door is frequently opened.</li><li>• Ensure that proper care and maintenance of the appliance has been performed (cleaning, defrosting, etc...)</li></ul>
Noise	<ul style="list-style-type: none"><li>• Refer to “Normal Operating Sounds” (page 13)</li></ul>
Light does not work	<ul style="list-style-type: none"><li>• Remove cover and check light bulb - replace if necessary.</li></ul>

### CUSTOMER RESPONSIBILITIES

The following items are the responsibility of the customer and are not covered by the warranty:

- Proper care and use of the appliance as described in this manual.
- Damage to the interior or exterior finish or components after delivery.
- Proper power supply, fuse, wiring, and connections.
- Service required as a result of alteration, misuse, abuse, flooding, fire, lightning, or other acts of God.
- Replacement of light bulbs.

# UGP-275L W PARTS DIAGRAM AND LIST

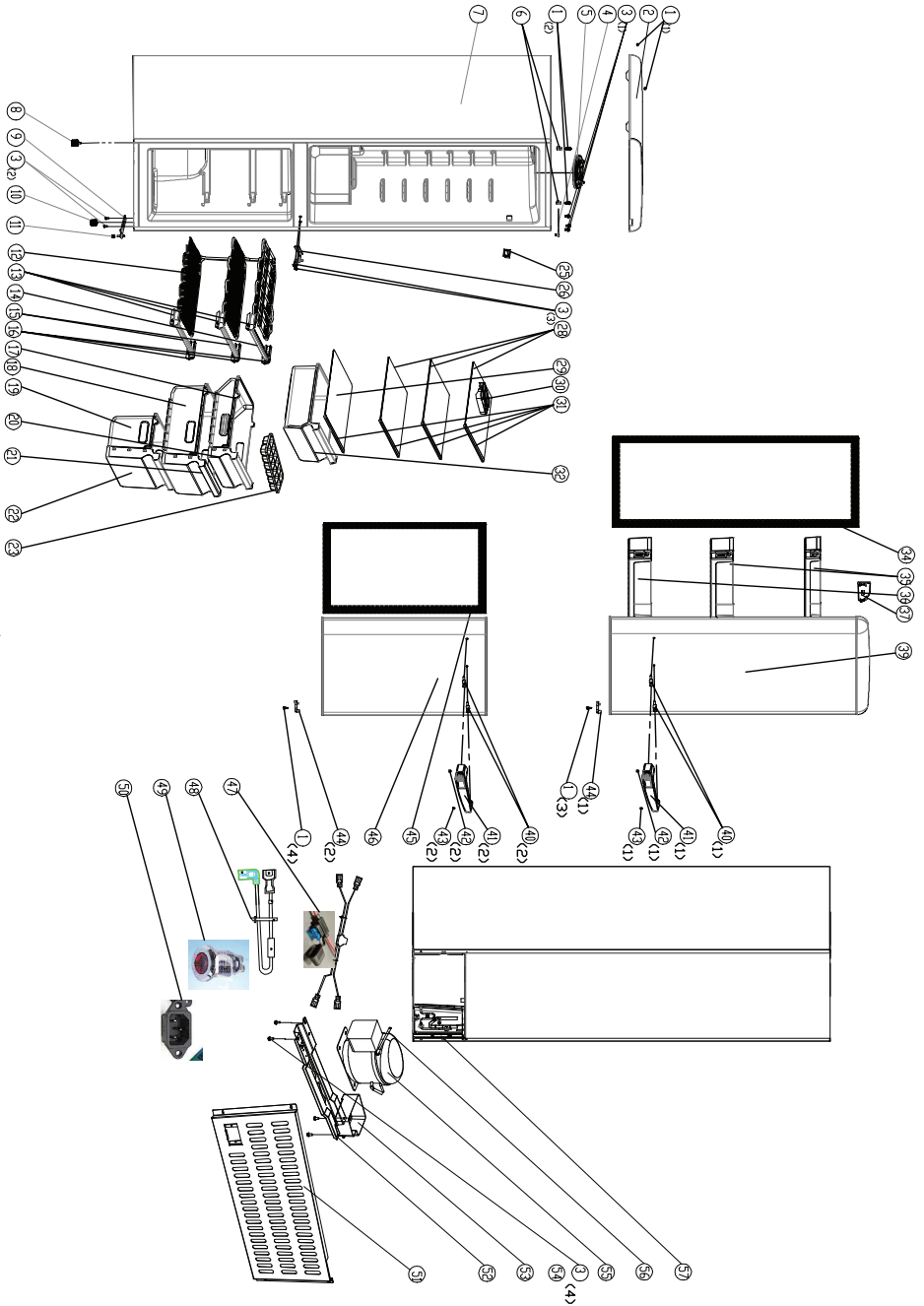

# PARTS DIAGRAM AND LIST continued

Item #	Part #	PART NAME
1	UGP-BCD275-1	Screw ST5x16
2	UGP-BCD275-2	Plastic Top cover
3	UGP-BCD275-3	Screw ST5x16
4	UGP-BCD275-4	Upper hinge group
5	UGP-BCD275-5	Light group
6	UGP-BCD275-6	cover fixing base
7	UGP-BCD275-7	Cabinet
8	UGP-BCD275-8	Adjustable foot
9	UGP-BCD275-9	Lower hinge parts
10	UGP-BCD275-10	Low adjustable foot 1
11	UGP-BCD275-11	Low adjustable foot 2
12	UGP-BCD275-12	F evaporator
13	UGP-BCD275-13	left stop block
14	UGP-BCD275-14	Ornament strip 1
15	UGP-BCD275-15	Ornament strip
16	UGP-BCD275-16	right stop block
17	UGP-BCD275-17	Top Crisper drawer body 1
18	UGP-BCD275-18	Top Crisper drawer body 2
19	UGP-BCD275-19	Crisper drawer body bottom 1
20	UGP-BCD275-20	Top Crisper drawer panel 1
21	UGP-BCD275-21	Top Crisper drawer panel 2
22	UGP-BCD275-22	Crisper drawer body panel
23	UGP-BCD275-23	Ice tray
25	UGP-BCD275-25	Door switch
26	UGP-BCD275-26	Middle hinge
28	UGP-BCD275-28	glass shevels
29	UGP-BCD275-29	Crisper drawer cover
30	UGP-BCD275-30	Egg tray
31	UGP-BCD275-31	Ornament strip for shelves
32	UGP-BCD275-32	Crisper drawer

# PARTS DIAGRAM AND LIST continued

Item #	Part #	PART NAME
34	UGP-BCD275-34	Upper door seal
35	UGP-BCD275-35	door rack 1
36	UGP-BCD275-36	door rack 2
37	UGP-BCD275-37	Top hinge group
39	UGP-BCD275-39	Upper door
40	UGP-BCD275-40	fixed base for handle
41	UGP-BCD275-41	handle
42	UGP-BCD275-42	screws M5*8
43	UGP-BCD275-43	screws M5*6
44	UGP-BCD275-44	door stopper
45	UGP-BCD275-45	Bottom door seal
46	UGP-BCD275-46	Bottom door
47	UGP-BCD275-47	Compressor connect cable
48	UGP-BCD275-48	The speed resistance cable
49	UGP-BCD275-49	Trouble light and cable
50	UGP-BCD275-50	blug
51	UGP-BCD275-51	back cover
52	UGP-BCD275-52	Compressor base
53	UGP-BCD275-53	Drip tray
54	UGP-BCD275-54	Process tube
55	UGP-BCD275-55	DC compressor
56	UGP-BCD275-56	process tube
57	UGP-BCD275-57	Drier filter



# WARRANTY

**Unique Appliances (hereafter “Unique”) warrants that this UNIQUE fridge is free from manufacturer’s defects in material and workmanship under normal usage and service under the following terms.**



## TERMS OF WARRANTY

Plastic parts are warranted for thirty (30) days from the date of purchase, with no extensions provided.

### Parts Warranty

This appliance has been designed for domestic household use. If properly installed, adjusted and operated under normal conditions in accordance with printed instructions, it will satisfactorily perform the functions that are generally expected of this type of appliance.

If the appliance fails to do so because of a defect in material or workmanship within **one year** from the original date of purchase: Unique will at our option, repair, exchange, or correct by other means Unique consider appropriate, any part(s) Unique finds to be defective except for the surface finish.

### Ownership

This Warranty is made only to the first purchaser (“original purchaser”) who acquires this fridge for his/her own use and will be honored by Unique Appliances. and by the Seller. Purchaser must retain their receipt as proof of purchase date.

### Warranty Conditions

This warranty does not apply to any appliance that has been subjected to alterations, misuse, abuse (including damage by foreign agents or chemicals), accident, improper installation or service, delivery damage, or other than normal household use and service. This UNIQUE appliance must be serviced regularly as outlined in the Owner’s Manual. Neither Unique Appliances. nor the selling dealer will be liable for direct or indirect loss of foods caused by failure in operation. In case of damage, the owner must provide proof of purchase, Model, and Serial Number to the selling dealer or Unique Appliances. This warranty is LIMITED STRICTLY to the terms indicated herein, and no other expressed warranties or remedies thereunder shall be binding on Unique.

### Purchaser’s Responsibilities

The purchaser will be responsible for the costs of any service calls requested to demonstrate or confirm the proper operation of the appliance, the installation, or to correct malfunctions in the appearance created by the operation of the appliance in a manner not prescribed by or cautioned against in the use and care instructions.

### Model and Serial Number

The appliance model number and serial number can be found on a rating plate attached at the back of the fridge. The purchaser should always refer to the model and serial number when talking to or contacting the dealer from whom the appliance was purchased.

# WARRANTY continued

## EXCLUSIONS

Save as herein provided, by Unique, there are no other warranties, conditions, representations or guarantees, express or implied, made or intended by Unique or its authorized distributors and all other warranties, conditions, representations or guarantees, including any warranties, conditions, representations or guarantees under any Sale of Goods Act or like legislation or statute is hereby expressly excluded. Save as herein provided, Unique shall not be responsible for any damages to persons or property, including the unit itself, howsoever caused or any consequential damages arising from the malfunction of the unit and by the purchase of the unit, the purchaser does hereby agree to indemnify and hold harmless Unique from any claim for damages to persons or property caused by the unit

Removal or disfigurement of the serial plate will void the warranty. The purchaser will be responsible for any expenses involved in making the refrigerator readily accessible for servicing. The purchaser will be responsible for any extra charges where the installation is in a remote location such as un-assumed roads, islands, areas known as cottage country, more than 20 Km outside a Metropolitan area, or where a technician is not available. Freight damage is not covered by this warranty.

## GENERAL PROVISIONS

No warranty or insurance herein contained or set out shall apply when damage or repair is caused by any of the following:

- 1) Power failure.
- 2) Damage in transit or when moving the appliance.
- 3) Improper power supply such as low voltage, defective house wiring or inadequate fuses.
- 4) Accident, alteration, abuse or misuse of the appliance such as inadequate air circulation in the room or abnormal operating conditions (ie. extremely high or low room temperature).
- 5) Use for commercial or industrial purposes (ie. If the appliance is not installed in a domestic residence).
- 6) Fire, water damage, theft, war, riot, hostility, acts of God such as hurricanes, floods etc.
- 7) Service calls resulting in customer education.
- 8) Improper Installation (ie. Building-in of a free standing appliance or using an appliance outdoors that is not approved for outdoor application, including but not limited to: garages, patios, porches or anywhere that is not properly insulated or climate controlled).

Proof of purchase date will be required for warranty claims; retain bills of sale. In the event that warranty service is required, present the proof of purchase to our authorized service depot.

**Nothing within this warranty shall imply that Unique will be responsible or liable for any spoilage or damage to food or other contents of this appliance, whether due to any defect of the appliance, or its use, whether proper or improper**

## Factory Assistance

If the purchaser is unable to locate an authorized dealer/service agent, or if the purchaser does not receive satisfaction from the dealer, they may contact Unique Appliances Customer Service directly at Toll Free 1-877-427-2266 or 905-827- 6154

## TECHNICAL SPECIFICATIONS

<b>MODEL</b>	<b>UGP-275L W</b>
SIZE	total: 10 cu/ft, 275 litres
OPERATION	•12V/24V
DIMENSIONS (unboxed)	H 71.2" x W 21.6" x D 24.2" H 181 cm x W 55 cm x D 61.5 cm
WEIGHT	112.4 lbs./51 kg
DC POWER	12V/24V
TOTAL WATT HR. STABLE RUNNING (24 DC) 24HR AT SETTING: #4	584 Wh/24hrs (set to -14°C freezer/+4°C fridge performance in a +25°C ambient)
TOTAL AMP HR. STABLE RUNNING (24 DC) 24HR AT SETTING: #4	21.5 Ah/24hrs (set to -14°C freezer/+4°C fridge performance in a +25°C ambient)
POWER CONSUMPTION 12V/24V	63 W
AV. RUN CURRENT	5.25A on 12V - 2.62A on 24V
FRIDGE TEMP. RANGE	-4°C to +10°C
FREEZER TEMP. RANGE	-15°C to -6°C

## PRODUCT REGISTRATION

Please visit our website at <https://uniqueappliances.com/product-registration/> to register your product.

## CONTACT US

For questions related to the operation, safety or the purchase of your fridge, please contact your dealer for more information. For general information, contact our customer service department:



[info@UniqueAppliances.com](mailto:info@UniqueAppliances.com)



1-877-427-2266 or 1-905-827-6154  
(available during regular business  
hours, 8:30 am to 4:30 pm, EST.)

**UNIQUE**  
APPLIANCES